

Ürün Kodu	Açıklama / Stok Cinsi	Ambalaj (Kutulu)	Ambalaj Birimi	TL
CANALEX SERİSİ TSE'Lİ KAPALI TİP KABLO KANALLARI (KUTULU)				
		TSE	CE	IP40
001 156 012012 20 00	12X12 MM KABLO KANALI (CANALEX)	250	mt	0.484
001 156 015010 20 00	15X10 MM KABLO KANALI (CANALEX)	250	mt	0.500
001 156 016016 20 00	16X16 MM KABLO KANALI (CANALEX)	250	mt	0.574
001 156 025016 20 00	25X16 MM KABLO KANALI (CANALEX)	150	mt	0.737
001 156 025025 20 00	25X25 MM KABLO KANALI (CANALEX)	100	mt	1.073
001 156 030016 20 00	30X16 MM KABLO KANALI (CANALEX)	140	mt	1.224
001 156 040016 20 00	40X16 MM KABLO KANALI (CANALEX)	100	mt	1.276
001 156 040025 20 00	40X25 MM KABLO KANALI (CANALEX)	80	mt	1.350
001 156 040040 20 00	40X40 MM KABLO KANALI (CANALEX)	50	mt	2.010
001 156 060040 20 00	60X40 MM KABLO KANALI (CANALEX)	40	mt	2.405
001 156 060060 20 00	60X60 MM KABLO KANALI (CANALEX)	32	mt	3.804
001 156 080040 20 00	80X40 MM KABLO KANALI (CANALEX)	30	mt	3.893
001 156 080060 20 00	80X60 MM KABLO KANALI (CANALEX)	24	mt	4.450
001 156 100040 20 00	100X40 MM KABLO KANALI (CANALEX)	24	mt	4.625
001 156 100060 20 00	100X60 MM KABLO KANALI (CANALEX)	20	mt	5.747

Ürün Kodu	Açıklama / Stok Cinsi	Ambalaj (Kutulu)	Ambalaj Birimi	TL
EKO SERİSİ TSE'Lİ KAPALI TİP KABLO KANALLARI (KUTULU)				
		TSE	CE	IP40
001 014 010008 20 00	10X08 MM KABLO KANALI-EKO	330	mt.	0.431
001 014 012012 20 00	12X12 MM KABLO KANALI-EKO	250	mt.	0.530
001 014 015010 20 00	15X10 MM KABLO KANALI-EKO	250	mt.	0.541
001 014 016016 20 00	16X16 MM KABLO KANALI-EKO	250	mt.	0.706
001 014 020010 20 00	20X10 MM KABLO KANALI-EKO	200	mt.	0.721
001 014 025016 20 00	25X16 MM KABLO KANALI-EKO	150	mt.	1.009
001 014 025025 20 00	25X25 MM KABLO KANALI-EKO	100	mt.	1.211
001 014 025040 20 00	25X40 MM KABLO KANALI-EKO	80	mt.	2.403
001 014 930010 20 00	30X10 MM KABLO KANALI-EKO (BÖLMELİ)	140	mt.	1.210
001 014 930016 20 00	30X16 MM KABLO KANALI-EKO (BÖLMELİ)	140	mt.	1.506
001 014 030016 20 00	30X16 MM KABLO KANALI-EKO	140	mt.	1.337
001 014 030025 20 00	30X25 MM KABLO KANALI-EKO	80	mt.	1.648
001 014 940016 20 00	40X16 MM KABLO KANALI-EKO (BÖLMELİ)	100	mt.	1.748
001 014 040016 20 00	40X16 MM KABLO KANALI-EKO	100	mt.	1.514
001 014 040025 20 00	40X25 MM KABLO KANALI-EKO	80	mt.	1.706
001 014 040040 20 00	40X40 MM KABLO KANALI-EKO	50	mt.	2.148
001 014 040060 20 00	40X60 MM KABLO KANALI-EKO	40	mt.	4.049
001 014 960025 20 00	60X25 MM KABLO KANALI-EKO (BÖLMELİ)	40	mt.	3.191
001 014 060040 20 00	60X40 MM KABLO KANALI-EKO	40	mt.	3.226
001 014 050050 20 00	50X50 MM KABLO KANALI-EKO	30	mt.	4.226
001 014 060060 20 00	60X60 MM KABLO KANALI-EKO	32	mt.	4.291
001 014 075075 20 00	75X75 MM KABLO KANALI-EKO	18	mt.	6.346
001 014 080040 20 00	80X40 MM KABLO KANALI-EKO	30	mt.	4.823
001 014 080060 20 00	80X60 MM KABLO KANALI-EKO	24	mt.	5.448
001 014 100040 20 00	100X40 MM KABLO KANALI-EKO (PRİZ SETİ TAKILABİLİR)	24	mt.	5.198
001 014 100037 20 00	100x37 İÇTEN KAPAKLI KANAL-EKO (PRİZ SETİ TAKILABİLİR)		Hazırılıkta	
001 014 100050 20 00	100X50 İÇTEN KAPAKLI KANAL-EKO (PRİZ SETİ TAKILABİLİR)	20	mt.	5.706
001 014 100060 20 00	100X60 MM KABLO KANALI-EKO (PRİZ SETİ TAKILABİLİR)	20	mt.	6.825
001 014 100100 20 00	100X100 MM KABLO KANALI-EKO	20	mt.	13.390

Ürün Kodu	Açıklama / Stok Cinsi	Ambalaj (Kutulu)	Ambalaj Birimi	TL
MEKS SERİSİ TSE'Lİ KAPALI TİP KABLO KANALLARI				
		TSE	CE	IP40
001 002 016016 20 00	16X16 MM KABLO KANALI-MEKS	250	mt.	0.904
001 002 025016 20 00	25X16 MM KABLO KANALI-MEKS	150	mt.	1.320
001 002 025025 20 00	25X25 MM KABLO KANALI-MEKS	100	mt.	1.581
001 002 040017 20 00	40X17 MM KABLO KANALI-TAM KAPAKLI-MEKS	100	mt.	1.962
001 002 040025 20 00	40X25 MM KABLO KANALI-MEKS	80	mt.	2.251
001 002 040040 20 00	40X40 MM KABLO KANALI-MEKS	50	mt.	2.854
001 002 960025 20 00	60X25 MM KABLO KANALI-MEKS (BÖLMELİ)	40	mt.	3.498
001 002 060040 20 00	60X40 MM KABLO KANALI-MEKS	40	mt.	4.039
001 002 975022 20 00	75X22 MM KABLO KANALI-MEKS (BÖLMELİ)	50	mt.	5.890
001 002 080060 20 00	80X60 MM KABLO KANALI-MEKS	24	mt.	6.534
001 002 100036 20 00	100X36 MM KABLO KANALI-MEKS	30	mt.	8.995
001 002 100040 20 00	100X40 MM KABLO KANALI-MEKS	24	mt.	9.405
001 002 100048 20 00	100X48 MM KABLO KANALI-MEKS	24	mt.	10.136
001 002 100060 20 00	100X60 MM KABLO KANALI-MEKS	20	mt.	11.045
001 002 120060 20 00	120X60 MM KABLO KANALI-MEKS	16	mt.	11.882

Ürün Kodu	Açıklama / Stok Cinsi	Ambalaj (Kutulu)	Ambalaj Birimi	TL
KANAL İÇİN UPS VE ENERJİ PRİZLERİ (45X45) TSE'LI				
001 052 500001 00 00	45X45 TOP.PRİZ ÇEKİRDEĞİ (ÇCK.KOR.) GEÇ.	TSE CE	50 ad.	4.635
001 052 500002 00 00	45X45 UPS TOP.PRİZ ÇEKİRDEĞİ (ÇCK.KOR.)GEÇ.	TSE CE	50 ad.	4.841
001 052 200002 00 00	45X45 PRİZ BİRLEŞTİRME APARATI	—	50	Hazırılıkta
888 049 050008	DATA KONNEKTÖRÜ CAT 5e (RJ65 8 Kontak Tolles)	—	1 ad.	1,80 USD.
888 049 050032	DATA KONNEKTÖRÜ CAT 6e (RJ65 8 Kontak Tolles)	—	1 ad.	2,20 USD.
888 049 050009	TELEFON KONNEKTÖRÜ (RJ 11/12 6 Kontak)	—	1 ad.	1,60 USD.
888 049 050013	45X45 DATA PRİZ KAPAĞI	—	1 ad.	1,00 USD.
888 049 050012	45X22,5 DATA PRİZ KAPAĞI	—	1 ad.	1,00 USD.



MEKSPUS SERİSİ KAPALI TİP KABLO KANALLARI				
		TSE	CE	IP40
001 003 040025 20 00	40X25 MM KABLO KANALI (İÇTEN KAPAKLI)	50	mt.	2.369
001 003 100037 20 00	100X37 MM KABLO KANALI (İÇTEN KAPAKLI)	30	mt.	8.482
001 003 100041 20 00	100X41 MM KABLO KANALI (İÇTEN KAPAKLI)	24	mt.	8.756
001 003 100050 20 00	100X50 MM KABLO KANALI (İÇTEN KAPAKLI)	20	mt.	10.809
YENİ 001 006 100050 20 00	100X50 KAİDESİZ MONTAJA UYGUN KABLO KANALI (İÇTEN KAPAKLI)	20	mt.	10.809
001 003 110060 20 00	110X60 MM KABLO KANALI (İÇTEN KAPAKLI)	20	mt.	11.492
001 003 120070 20 00	120X70 MM KABLO KANALI (İÇTEN KAPAKLI)	16	mt.	14.958
001 003 170070 20 00	170X70 MM KABLO KANALI (İÇTEN KAPAKLI)	12	mt.	21.843
001 003 250070 20 00	250X70 MM KABLO KANALI (İÇTEN KAPAKLI)	8	mt.	31.930



YAPIŞKAN BANTLI KAPALI TİP KABLO KANALLARI				
		TSE	CE	IP40
001 004 009005 20 00	9X5 MM KEN.KAPAKLI KANAL-YPŞK.BANTLI	500	mt.	0.590
001 004 010007 20 44	9,5X7,5 MM ŞEFFAF MİNİ KANAL-YPŞK.BANTLI	500	mt.	0.939
001 004 012007 20 00	12X7,5 MM KEN.KAPAKLI KANAL-YPŞK.BANTLI	350	mt.	0.683
001 004 013012 20 00	13X12,5 MM KEN.KAPAKLI KANAL-YPŞK.BANTLI	300	mt.	0.987
001 004 010008 20 00	10X8 MM KABLO KANALI-YPŞK.BANTLI	330	mt.	0.641
001 004 012012 20 00	12X12 MM KABLO KANALI-YPŞK.BANTLI	250	mt.	0.801
001 004 015010 20 00	15X10 MM KABLO KANALI-YPŞK.BANTLI	250	mt.	0.849
001 004 016016 20 00	16X16 MM KABLO KANALI-YPŞK.BANTLI	230	mt.	1.112
001 004 020010 20 00	20X10 MM KABLO KANALI-YPŞK.BANTLI	180	mt.	0.947
001 004 025016 20 00	25X16 MM KABLO KANALI-YPŞK.BANTLI	140	mt.	1.715
001 004 025025 20 00	25X25 MM KABLO KANALI-YPŞK.BANTLI	100	mt.	1.904
001 004 025040 20 00	25X40 MM KABLO KANALI-YPŞK.BANTLI	80	mt.	2.786
001 004 930010 20 00	30X10 MM KABLO KANALI-YPŞK.BANTLI	140	mt.	1.650
001 004 930016 20 00	30X16 MM KABLO KANALI-YPŞK.BANTLI-BÖLM.	140	mt.	1.810
001 004 030025 20 00	30X25 MM KABLO KANALI-YPŞK.BANTLI	80	mt.	2.263
001 004 040016 20 00	40X16 MM KABLO KANALI-YPŞK.BANTLI	100	mt.	2.388
001 004 040025 20 00	40X25 MM KABLO KANALI-YPŞK.BANTLI	80	mt.	2.798
001 004 040040 20 00	40X40 MM KABLO KANALI-YPŞK.BANTLI	50	mt.	3.394
001 004 060015 20 17	60X15 MM BALIK SIRTİ -YPŞK.BANTLI	80	mt.	3.320
001 004 075018 20 17	75X18 MM BALIK SIRTİ -YPŞK BANTLI	60	mt.	5.508
001 004 090020 20 17	90X20 MM BALIK SIRTİ -YPŞK BANTLI	40	mt.	7.556

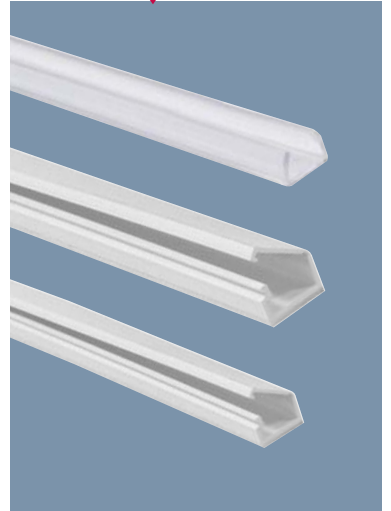

MEKS SERİSİ KLİMA KANALI VE AKSESUARLARI				
		TSE	CE	IP40
001 002 075060 20 00	75X60 MM KLİMA KANALI	30	mt.	5.778
001 050 030002 00 00	KLİMA KANALI KABLO TUTUCUSU	60	ad.	0.499
001 043 075060 00 00	KLİMA KANALI EK PARÇASI	40	ad.	0.499
001 039 075060 00 00	KLİMA KANALI İÇ KÖŞE	24	ad.	1.496
001 040 075060 00 00	KLİMA KANALI DIŞ KÖŞE	24	ad.	1.700
001 042 075060 00 00	KLİMA KANALI L KÖŞE	18	ad.	1.756
001 050 030001 00 00	KLİMA KANALI DUVAR GEÇİŞİ	60	ad.	0.567
001 044 075060 01 00	KLİMA KANALI İÇ SONLAMA	30	ad.	1.496
001 044 075060 02 00	KLİMA KANALI DIŞ SONLAMA	18	ad.	1.496



TAVAN KÖŞE KANALI				
		TSE	CE	IP40
001 002 023023 20 00	23X23 MM TAVAN KÖŞE KANALI	120	mt.	1.854
001 039 023023 00 00	23X23 MM TAVAN KÖŞE KANALI İÇ KÖŞE	60	ad.	0.756
001 040 023023 00 00	23X23 MM TAVAN KÖŞE KANALI DIŞ KÖŞE	60	ad.	0.756
001 043 023023 00 00	23X23 MM TAVAN KÖŞE KANALI EK PARÇA	100	ad.	0.756
001 044 023023 00 00	23X23 MM TAVAN KÖŞE KANALI SONLAMA	100	ad.	0.756
001 041 023023 00 00	23X23 MM TAVAN KÖŞE KANALI T KÖŞE	60	ad.	0.756
001 050 030008 00 00	23X23 MM TAVAN KÖŞE KANALI KABLO TAŞIYICI	1	ad.	0.756

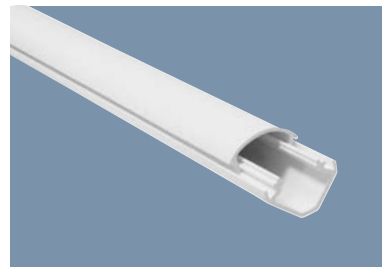

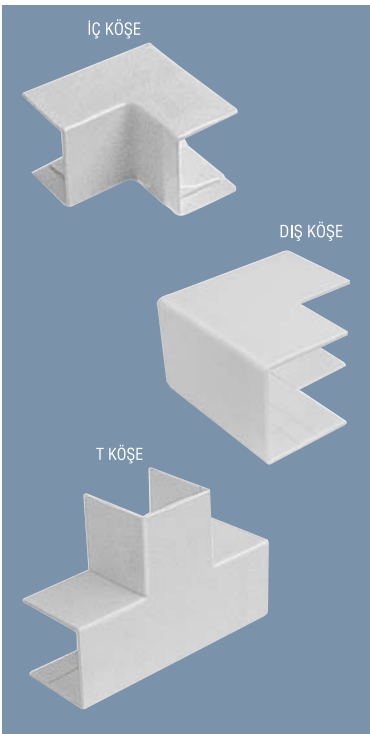
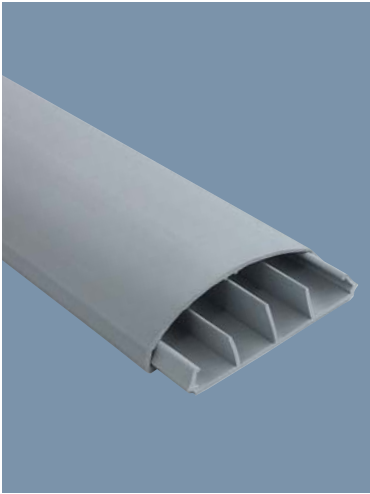
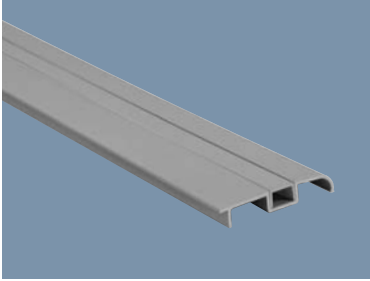

Ürün Kodu	Açıklama / Stok Cinsi	Ambalaj (Kutulu)	Ambalaj Birimi	TL
FUGALI SÜPÜRGELİK				
001 010 000200 20 00	50'LİK FUGALI SÜPÜRGELİK	60	mt.	1.854
001 039 000200 00 00	50'LİK FUGALI SÜPÜRGELİK İÇ KÖŞE	40	ad.	0.756
001 040 000200 00 00	50'LİK FUGALI SÜPÜRGELİK DİŞ KÖŞE	40	ad.	0.756
001 044 000200 02 00	50'LİK FUGALI SÜPÜRGELİK SONLAMA SOL	100	ad.	0.756
001 044 000200 01 00	50'LİK FUGALI SÜPÜRGELİK SONLAMA SAĞ	100	ad.	0.756

TEZGAH SÜPÜRGELİĞİ				
001 011 000100 00 00	25'LİK TEZGAH SÜPÜRGELİĞİ 100CM	60	mt.	2.678
001 039 000100 00 00	25'LİK TEZGAH SÜPÜRGELİĞİ İÇ KÖŞE	1	ad.	0.592
001 040 000100 00 00	25'LİK TEZGAH SÜPÜRGELİĞİ DİŞ KÖŞE	1	ad.	0.592
001 044 000100 02 00	25'LİK TEZGAH SÜPÜRGELİĞİ SONLAMA SOL	1	ad.	0.592
001 044 000100 01 00	25'LİK TEZGAH SÜPÜRGELİĞİ SONLAMA SAĞ	1	ad.	0.592
001 043 000100 00 00	25'LİK TEZGAH SÜPÜRGELİĞİ EK PARÇASI	1	ad.	0.592

BALIK SIRTI ZEMİN KANALLARI				
		TS	CE	IP40
001 002 060015 20 00	60X15 MM BALIK SIRTI KANAL (ZEMİN İÇİN)	80	mt.	3.279
001 042 060015 00 17	60X15 MM BALIK SIRTI KANAL L KÖŞE	24	ad.	0.782
001 043 060015 00 17	60X15 MM BALIK SIRTI KANAL EK PARÇASI	50	ad.	0.474
001 044 060015 00 17	60X15 MM BALIKSIRTI KANAL SONLAMA KAPAĞI	50	ad.	0.415
001 041 060015 00 17	60X15 MM BALIK SIRTI KANAL T KÖŞE	10	ad.	1.648
001 002 075018 20 00	75X18 MM BALIK SIRTI KANAL (ZEMİN İÇİN)	60	mt.	4.944
001 042 075018 00 17	75X18 MM BALIK SIRTI KANAL L KÖŞE	1	ad.	0.860
001 043 075018 00 17	75X18 MM BALIK SIRTI KANAL EK PARÇASI	1	ad.	0.430
001 044 075018 00 17	75X18 MM BALIKSIRTI KANAL SONLAMA KAPAĞI	1	ad.	0.430
001 041 075018 00 17	75X18 MM BALIK SIRTI KANAL T KÖŞE	1	ad.	1.629
001 002 090020 20 17	90X20 MM BALIK SIRTI KANAL (ZEMİN İÇİN)	40	mt.	7.004
001 042 090020 00 17	90X20 MM BALIK SIRTI KANAL L KÖŞE	20	ad.	1.066
001 043 090020 00 17	90X20 MM BALIK SIRTI KANAL EK PARÇASI	50	ad.	0.474
001 044 090020 00 17	90X20 MM BALIKSIRTI KANAL SONLAMA KAPAĞI	50	ad.	0.474
001 041 090020 00 17	90X20 MM BALIK SIRTI KANAL T KÖŞE	12	ad.	1.895

12X12 KANAL AKSESUARLARI				
		TS	CE	IP40
001 039 012012 00 00	12X12 MM İÇ KÖŞE	60	ad.	0.510
001 040 012012 00 00	12X12 MM DİŞ KÖŞE	60	ad.	0.510
001 041 012012 00 00	12X12 MM T KÖŞE	60	ad.	0.510
001 042 012012 00 00	12X12 MM 90 L KÖŞE	60	ad.	0.510
001 044 012012 00 00	12X12 MM UÇ TAPA	100	ad.	0.510
001 043 012012 00 00	12X12 MM EK PARÇASI	100	ad.	0.510

15X10 KANAL AKSESUARLARI				
		TS	CE	IP40
001 039 015010 00 00	15X10 MM İÇ KÖŞE	60	ad.	0.533
001 040 015010 00 00	15X10 MM DİŞ KÖŞE	60	ad.	0.533
001 041 015010 00 00	15X10 MM T KÖŞE	60	ad.	0.533
001 042 015010 00 00	15X10 MM 90 L KÖŞE	60	ad.	0.533
001 044 015010 00 00	15X10 MM UÇ TAPA	100	ad.	0.533
001 043 015010 00 00	15X10 MM EK PARÇASI	100	ad.	0.533

20X10 KANAL AKSESUARLARI				
		TS	CE	IP40
001 039 020010 00 00	20X10 MM İÇ KÖŞE	60	ad.	0.563
001 040 020010 00 00	20X10 MM DİŞ KÖŞE	60	ad.	0.563
001 041 020010 00 00	20X10 MM T KÖŞE	30	ad.	0.563
001 042 020010 00 00	20X10 MM 90 L KÖŞE	50	ad.	0.563
001 044 020010 00 00	20X10 MM UÇ TAPA	100	ad.	0.563
001 043 020010 00 00	20X10 MM EK PARÇASI	100	ad.	0.563

Ürün Kodu	Açıklama / Stok Cinsi	Ambalaj (Kutulu)	Ambalaj Birimi	TL
16X16 KANAL AKSESUARLARI				
		TS	CE	IP40
001 039 016016 00 00	16X16 MM İÇ KÖŞE	60	ad.	0.546
001 040 016016 00 00	16X16 MM DIŞ KÖŞE	60	ad.	0.546
001 041 016016 00 00	16X16 MM T KÖŞE	60	ad.	0.546
001 042 016016 00 00	16X16 MM 90 L KÖŞE	60	ad.	0.546
001 044 016016 00 00	16X16 MM UÇ TAPA	100	ad.	0.546
001 043 016016 00 00	16X16 MM EK PARÇASI	100	ad.	0.546
25X16 KANAL AKSESUARLARI				
		TS	CE	IP40
001 039 025016 00 00	25X16 MM İÇ KÖŞE	40	ad.	0.592
001 040 025016 00 00	25X16 MM DIŞ KÖŞE	40	ad.	0.592
001 041 025016 00 00	25X16 MM T KÖŞE	30	ad.	0.592
001 042 025016 00 00	25X16 MM 90 L KÖŞE	50	ad.	0.592
001 044 025016 00 00	25X16 MM UÇ TAPA	100	ad.	0.592
001 043 025016 00 00	25X16 MM EK PARÇA	100	ad.	0.592
001 047 012516 00 00	25X16 MM PRİZ MONTAJ KASASI	6	ad.	3.080
25X25 KANAL AKSESUARLARI				
		TS	CE	IP40
001 039 025025 00 00	25X25 MM İÇ KÖŞE	40	ad.	0.622
001 040 025025 00 00	25X25 MM DIŞ KÖŞE	40	ad.	0.622
001 041 025025 00 00	25X25 MM T PARÇASI	24	ad.	0.622
001 042 025025 00 00	25X25 MM 90 L KÖŞE	40	ad.	0.622
001 044 025025 00 00	25X25 MM UÇ TAPA	100	ad.	0.622
001 043 025025 00 00	25X25 MM EK PARÇA	50	ad.	0.622
001 047 012525 00 00	25X25 MM PRİZ MONTAJ KASASI	6	ad.	3.080
30X10 KANAL AKSESUARLARI				
		TS	CE	IP40
001 039 030010 00 00	30X10 MM İÇ KÖŞE	50	ad.	0.681
001 040 030010 00 00	30X10 MM DIŞ KÖŞE	50	ad.	0.681
001 041 030010 00 00	30X10 MM T PARÇASI	50	ad.	0.681
001 042 030010 00 00	30X10 MM 90 L KÖŞE	50	ad.	0.681
001 044 030010 00 00	30X10 MM UÇ TAPA	100	ad.	0.681
001 043 030010 00 00	30X10 MM EK PARÇA	100	ad.	0.681
30X16 KANAL AKSESUARLARI				
		TS	CE	IP40
001 039 030016 00 00	30X16 MM İÇ KÖŞE	35	ad.	0.681
001 040 030016 00 00	30X16 MM DIŞ KÖŞE	48	ad.	0.681
001 041 030016 00 00	30X16 MM T PARÇASI	40	ad.	0.681
001 042 030016 00 00	30X16 MM 90 L KÖŞE	50	ad.	0.681
001 044 030016 00 00	30X16 MM UÇ TAPA	100	ad.	0.681
001 043 030016 00 00	30X16 MM EK PARÇA	100	ad.	0.681
30X25 KANAL AKSESUARLARI				
		TS	CE	IP40
001 039 030025 00 00	30X25 MM İÇ KÖŞE	32	ad.	0.770
001 040 030025 00 00	30X25 MM DIŞ KÖŞE	30	ad.	0.770
001 041 030025 00 00	30X25 MM T PARÇASI	24	ad.	0.770
001 042 030025 00 00	30X25 MM 90 L KÖŞE	30	ad.	0.770
001 044 030025 00 00	30X25 MM UÇ TAPA	100	ad.	0.770
001 043 030025 00 00	30X25 MM EK PARÇA	100	ad.	0.770
40X16 KANAL AKSESUARLARI				
		TS	CE	IP40
001 039 040016 00 00	40X16 MM İÇ KÖŞE	32	ad.	0.948
001 040 040016 00 00	40X16 MM DIŞ KÖŞE	30	ad.	0.948
001 041 040016 00 00	40X16 MM T KÖŞE	24	ad.	0.948
001 042 040016 00 00	40X16 MM 90 L KÖŞE	34	ad.	0.948
001 044 040016 00 00	40X16 MM UÇ TAPA	25	ad.	0.948
001 043 040016 00 00	40X16 MM EK PARÇASI	100	ad.	0.948
001 047 014016 00 00	40X16 MM PRİZ MONTAJ KASASI	6	ad.	3.080

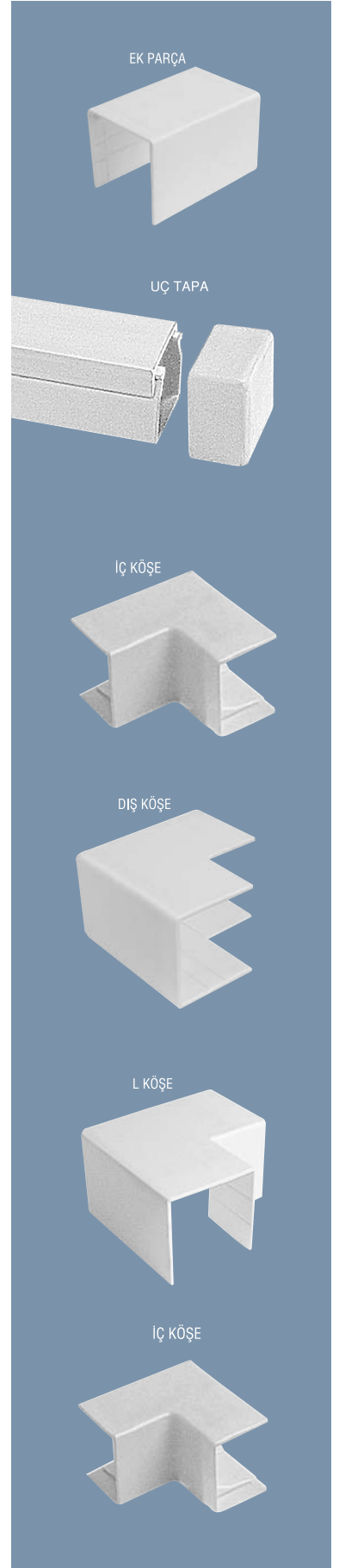

DIŞ KÖŞE

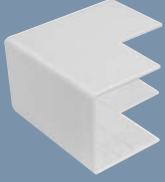
PRİZ MONTAJ KASASI
(45x45)

L KÖŞE

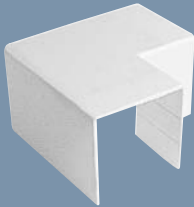

SONLAMA

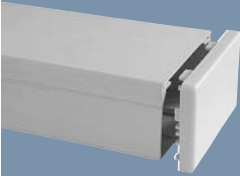

EK PARÇA



T KÖŞE

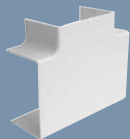

İÇ KÖŞE

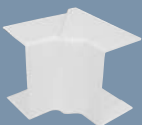

DIŞ KÖŞE

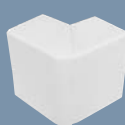

Ürün Kodu	Açıklama / Stok Cinsi	Ambalaj (Kutulu)	Ambalaj Birimi	TL
40X25 KANAL AKSESUARLARI				
001 039 040025 00 00	40X25 MM İÇ KÖŞE	24	ad.	0.948
001 040 040025 00 00	40X25 MM DIŞ KÖŞE	30	ad.	0.948
001 041 040025 00 00	40X25 MM T KÖŞE	18	ad.	0.948
001 042 040025 00 00	40X25 MM 90 L KÖŞE	24	ad.	0.948
001 044 040025 00 00	40X25 MM UÇ TAPA	25	ad.	0.948
001 043 040025 00 00	40X25 MM EK PARÇASI	70	ad.	0.948
001 047 014025 00 00	40X25 MM PRİZ MONTAJ KASASI	6	ad.	3.080
40X40 KANAL AKSESUARLARI				
001 039 040040 00 00	40X40 MM İÇ KÖŞE	18	ad.	0.995
001 040 040040 00 00	40X40 MM DIŞ KÖŞE	10	ad.	0.995
001 041 040040 00 00	40X40 MM T PARÇASI	48	ad.	0.995
001 042 040040 00 00	40X40 MM 90 L KÖŞE	60	ad.	0.995
001 044 040040 00 00	40X40 MM UÇ TAPA	25	ad.	0.995
001 043 040040 00 00	40X40 MM EK PARÇA	100	ad.	0.995
001 047 014040 00 00	40X40 MM PRİZ MONTAJ KASASI	6	ad.	3.080
74X20 KANAL AKSESUARLARI				
001 039 074020 00 00	74X20 MM İÇ KÖŞE	20	ad.	1.036
001 040 074020 00 00	74X20 MM DIŞ KÖŞE	20	ad.	1.036
001 041 074020 00 00	74X20 MM T PARÇASI	30	ad.	1.036
001 042 074020 00 00	74X20 MM 90 L KÖŞE	40	ad.	1.036
001 044 074020 00 00	74X20 MM UÇ TAPA	50	ad.	1.036
001 043 074020 00 00	74X20 MM EK PARÇA	50	ad.	1.036
001 047 017420 00 00	74X20 MM PRİZ MONTAJ KASASI	6	ad.	3.080
001 047 017421 00 00	74X20 MM PRİZ MONTAJ KASASI (45X45)	12	ad.	3.080
75X22 KANAL AKSESUARLARI				
001 039 075022 00 00	75X22 MM İÇ KÖŞE	20	ad.	1.232
001 040 075022 00 00	75X22 MM DIŞ KÖŞE	20	ad.	1.232
001 044 075022 01 00	75X22 MM SAĞ SONLAMA	30	ad.	1.232
001 044 075022 02 00	75X22 MM SOL SONLAMA	20	ad.	1.232
001 043 075022 00 00	75X22 MM EK PARÇASI	100	ad.	1.232
60X25 KANAL AKSESUARLARI				
001 039 060025 00 00	60X25 MM İÇ KÖŞE	48	ad.	2.487
001 040 060025 00 00	60X25 MM DIŞ KÖŞE	72	ad.	2.487
001 041 060025 00 00	60X25 MM T PARÇASI	40	ad.	2.487
001 042 060025 00 00	60X25 MM 90 L KÖŞE	60	ad.	2.487
001 044 060025 00 00	60X25 MM UÇ TAPA	50	ad.	1.007
001 043 060025 00 00	60X25 MM EK PARÇA	60	ad.	0.770
60X40 KANAL AKSESUARLARI				
001 039 060040 00 00	60X40 MM İÇ KÖŞE	26	ad.	2.487
001 040 060040 00 00	60X40 MM DIŞ KÖŞE	32	ad.	2.487
001 041 060040 00 00	60X40 MM T PARÇASI	32	ad.	2.487
001 042 060040 00 00	60X40 MM 90 L KÖŞE	40	ad.	2.487
001 044 060040 00 00	60X40 MM UÇ TAPA	50	ad.	1.007
001 043 060040 00 00	60X40 MM EK PARÇA	40	ad.	0.770
60X60 KANAL AKSESUARLARI				
001 039 060060 00 00	60X60 MM İÇ KÖŞE	16	ad.	2.487
001 040 060060 00 00	60X60 MM DIŞ KÖŞE	16	ad.	2.487
001 041 060060 00 00	60X60 MM T PARÇASI	20	ad.	2.487
001 042 060060 00 00	60X60 MM 90 L KÖŞE	24	ad.	2.487
001 044 060060 00 00	60X60 MM UÇ TAPA	30	ad.	1.007
001 043 060060 00 00	60X60 MM EK PARÇA	25	ad.	0.770
80X40 KANAL AKSESUARLARI				
001 039 080040 00 00	80X40 MM İÇ KÖŞE	18	ad.	2.665
001 040 080040 00 00	80X40 MM DIŞ KÖŞE	8	ad.	2.665
001 041 080040 00 00	80X40 MM T PARÇASI	12	ad.	2.665
001 042 080040 00 00	80X40 MM 90 L KÖŞE	16	ad.	2.665
001 044 080040 00 00	80X40 MM UÇ TAPA	60	ad.	1.007
001 043 080040 00 00	80X40 MM EK PARÇA	100	ad.	0.770
80X60 KANAL AKSESUARLARI				
001 039 080060 00 00	80X60 MM İÇ KÖŞE	12	ad.	2.784
001 040 080060 00 00	80X60 MM DIŞ KÖŞE	8	ad.	2.784
001 041 080060 00 00	80X60 MM T PARÇASI	10	ad.	2.784
001 042 080060 00 00	80X60 MM 90 L KÖŞE	12	ad.	2.784
001 044 080060 00 00	80X60 MM UÇ TAPA	48	ad.	1.007
001 043 080060 00 00	80X60 MM EK PARÇA	80	ad.	0.770

Ürün Kodu	Açıklama / Stok Cinsi	Ambalaj (Kutulu)	Ambalaj Birimi	TL
100X36 KANAL AKSESUARLARI				
		TS	CE	IP40
001 039 100036 00 00	100X36 MM İÇ KÖŞE (SABİT)	8	ad.	2.902
001 040 100036 00 00	100X36 MM DIŞ KÖŞE (SABİT)	8	ad.	2.902
001 039 100036 01 00	100X36 MM İÇ KÖŞE (HAREKETLİ)	8	ad.	2.902
001 040 100036 01 00	100X36 MM DIŞ KÖŞE (HAREKETLİ)	10	ad.	2.902
001 041 100036 00 00	100X36 MM T PARÇASI	12	ad.	2.902
001 042 100036 00 00	100X36 MM 90 L KÖŞE	12	ad.	2.902
001 044 100036 00 00	100X36 MM UÇ TAPA	20	ad.	1.442
001 043 100036 00 00	100X36 MM EK PARÇA	100	ad.	0.770
001 050 030004 00 00	100X36 MM KANAL KİLİTLEME APARATI	100	ad.	0.355
001 013 100036 20 00	100X36 MM ARA BÖLME	200	mt.	1.481
100X37 KANAL AKSESUARLARI				
		TS	CE	IP40
001 039 100037 00 00	100X37 MM İÇ KÖŞE (SABİT)	12	ad.	2.902
001 040 100037 00 00	100X37 MM DIŞ KÖŞE (SABİT)	8	ad.	2.902
001 039 100037 01 00	100X37 MM İÇ KÖŞE (HAREKETLİ)	12	ad.	2.902
001 040 100037 01 00	100X37 MM DIŞ KÖŞE (HAREKETLİ)	10	ad.	2.902
001 041 100037 00 00	100X37 MM T PARÇASI	12	ad.	2.902
001 042 100037 00 00	100X37 MM 90 L KÖŞE	12	ad.	2.902
001 044 100037 00 00	100X37 MM UÇ TAPA	50	ad.	1.442
001 043 100037 00 00	100X37 MM EK PARÇA	100	ad.	0.770
100X40 KANAL AKSESUARLARI				
		TS	CE	IP40
001 039 100040 00 00	100X40 MM İÇ KÖŞE (SABİT)	8	ad.	2.902
001 040 100040 00 00	100X40 MM DIŞ KÖŞE (SABİT)	8	ad.	2.902
001 039 100040 01 00	100X40 MM İÇ KÖŞE (HAREKETLİ)	8	ad.	2.902
001 040 100040 01 00	100X40 MM DIŞ KÖŞE (HAREKETLİ)	10	ad.	2.902
001 041 100040 00 00	100X40 MM T PARÇASI	12	ad.	2.902
001 042 100040 00 00	100X40 MM 90 L KÖŞE	12	ad.	2.902
001 044 100040 00 00	100X40 MM UÇ TAPA	20	ad.	1.442
001 043 100040 00 00	100X40 MM EK PARÇA	100	ad.	0.770
001 050 030004 00 00	100X40 MM KANAL KİLİTLEME APARATI	100	ad.	0.355
001 013 100040 20 00	100X40 MM ARA BÖLME	200	mt.	1.481
100X48 KANAL AKSESUARLARI				
		TS	CE	IP40
001 039 100048 00 00	100X48 MM İÇ KÖŞE (SABİT)	8	ad.	2.902
001 040 100048 00 00	100X48 MM DIŞ KÖŞE (SABİT)	8	ad.	2.902
001 039 100048 01 00	100X48 MM İÇ KÖŞE (HAREKETLİ)	8	ad.	2.902
001 040 100048 01 00	100X48 MM DIŞ KÖŞE (HAREKETLİ)	10	ad.	2.902
001 041 100048 00 00	100X48 MM T PARÇASI	8	ad.	2.902
001 042 100048 00 00	100X48 MM 90 L KÖŞE	8	ad.	2.902
001 044 100048 00 00	100X48 MM UÇ TAPA	20	ad.	1.442
001 043 100048 00 00	100X48 MM EK PARÇA	100	ad.	0.770
001 050 030004 00 00	100X48 MM KANAL KİLİTLEME APARATI	100	ad.	0.355
001 013 100048 20 00	100X48 MM ARA BÖLME	150	mt.	1.540
MEKSPLUS SERİSİ 100X37/50 İÇİN PRİZ SETLERİ (45x45)				
		TS	CE	IP40
001 047 070001 00 00	100X37/50 İÇİN 45X45 P.M.SETİ (TEK Lİ) YENİ	20	ad.	2.724
001 047 070002 00 00	100X37/50 İÇİN 45X45 P.M.SETİ (İKİLİ) YENİ	14	ad.	2.961
001 047 070003 00 00	100X37/50 İÇİN 45X45 P.M.SETİ (ÜÇLÜ) YENİ	12	ad.	3.376
001 047 070004 00 00	100X37/50 İÇİN 45X45 P.M.SETİ (DÖRTLÜ) YENİ	10	ad.	4.169
MEKSPLUS SERİSİ 100X37/50 İÇİN PRİZ SETLERİ (55X55)				
		TS	CE	IP40
001 047 080001 00 00	100X37/50 İÇİN P.M.SETİ (TEK Lİ) YENİ	20	ad.	2.724
001 047 080002 00 00	100X37/50 İÇİN P.M.SETİ (İKİLİ) YENİ	14	ad.	2.961
001 047 080003 00 00	100X37/50 İÇİN P.M.SETİ (ÜÇLÜ) YENİ	12	ad.	3.376
001 047 080004 00 00	100X37/50 İÇİN P.M.SETİ (DÖRTLÜ) YENİ	10	ad.	4.169
100X50 KANAL AKSESUARLARI				
		TS	CE	IP40
001 039 100050 00 00	100X50 MM İÇ KÖŞE (SABİT)	8	ad.	2.902
001 040 100050 00 00	100X50 MM DIŞ KÖŞE (SABİT)	8	ad.	2.902
001 039 100050 01 00	100X50 MM İÇ KÖŞE (HAREKETLİ)	12	ad.	2.902
001 040 100050 01 00	100X50 MM DIŞ KÖŞE (HAREKETLİ)	10	ad.	2.902
001 041 100050 00 00	100X50 MM T PARÇASI	8	ad.	2.902
001 042 100050 00 00	100X50 MM 90 L KÖŞE	8	ad.	2.902
001 044 100050 00 00	100X50 MM UÇ TAPA	40	ad.	1.442
001 043 100050 00 00	100X50 MM EK PARÇA	100	ad.	0.770

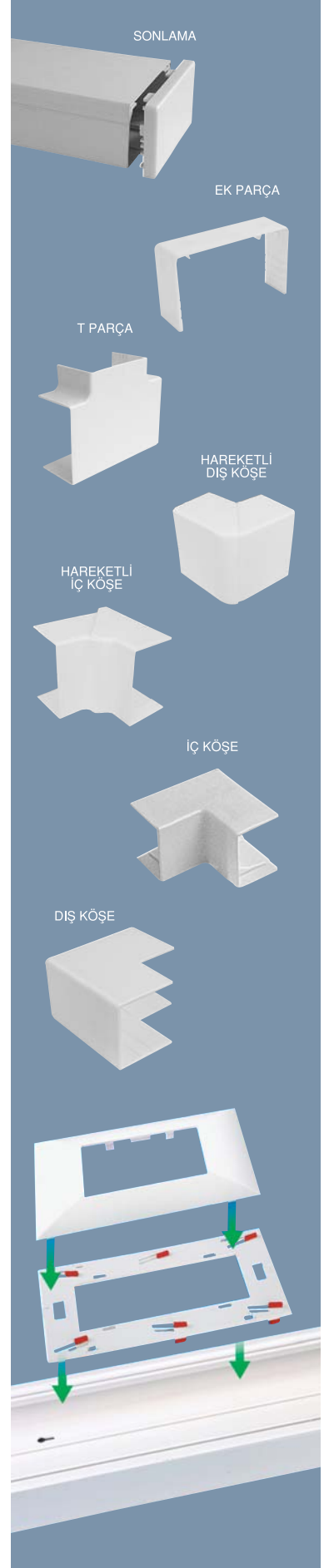

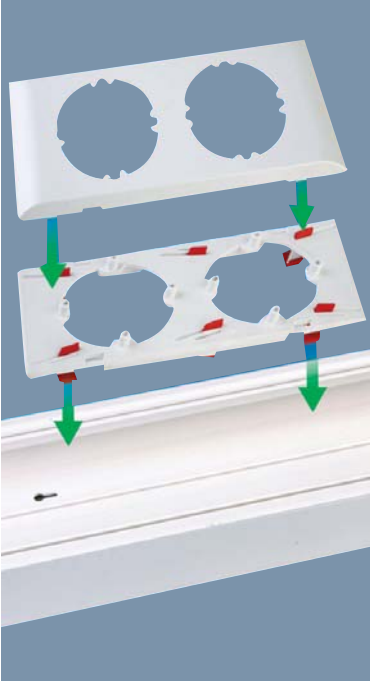

Ürün Kodu	Açıklama / Stok Cinsi	Ambalaj (Kutulu)	Ambalaj Birimi	TL
100X60 KANAL AKSESUARLARI				
001 039 100060 00 00	100X60 MM İÇ KÖŞE (SABİT)	8	ad.	2.902
001 040 100060 00 00	100X60 MM DIŞ KÖŞE (SABİT)	8	ad.	2.902
001 039 100060 01 00	100X60 MM İÇ KÖŞE (HAREKETLİ)	8	ad.	2.902
001 040 100060 01 00	100X60 MM DIŞ KÖŞE (HAREKETLİ)	10	ad.	2.902
001 041 100060 00 00	100X60 MM T PARÇASI	8	ad.	2.902
001 042 100060 00 00	100X60 MM 90 L KÖŞE	8	ad.	2.902
001 044 100060 00 00	100X60 MM UÇ TAPA	20	ad.	1.442
001 043 100060 00 00	100X60 MM EK PARÇA	100	ad.	0.770
001 050 030004 00 00	100X60 MM KANAL KİLİTLEME APARATI	100	ad.	0.355
001 013 100060 20 00	100X60 MM ARA BÖLME	130	mt.	1.718
MEKS SERİSİ 100'LÜK KANAL. İÇİN PRİZ MONTAJ SET. (55X55)				
001 047 020001 00 00	100'LÜK KANAL İÇİN P.M.SETİ TEKLİ	20	ad.	2.724
001 047 020002 00 00	100'LÜK KANAL İÇİN P.M.SETİ İKİLİ	14	ad.	2.961
001 047 020003 00 00	100'LÜK KANAL İÇİN P.M.SETİ ÜÇLÜ	12	ad.	3.376
MEKS SERİSİ 100'LÜK KANAL. İÇİN PRİZ MONTAJ SET. (45X45)				
001 047 040001 00 00	100'LÜK KANAL İÇİN 45X45 P.M.SETİ TEKLİ	20	ad.	2.724
001 047 040002 00 00	100'LÜK KANAL İÇİN 45X45 P.M.SETİ İKİLİ	14	ad.	2.961
001 047 040003 00 00	100'LÜK KANAL İÇİN 45X45 P.M.SETİ ÜÇLÜ	12	ad.	3.376
001 047 040004 00 00	100'LÜK KANAL İÇİN 45X45 P.M.SETİ DÖRTLÜ	10	ad.	3.966
120X60 KANAL AKSESUARLARI				
001 039 120060 00 00	120X60 MM İÇ KÖŞE	8	ad.	3.198
001 040 120060 00 00	120X60 MM DIŞ KÖŞE	8	ad.	3.198
001 041 120060 00 00	120X60 MM T PARÇA	8	ad.	3.198
001 042 120060 00 00	120X60 MM 90 L KÖŞE	8	ad.	3.198
001 047 060001 00 00	120X60 MM PRİZ MONTAJ ÇERV.TEKLİ	20	ad.	2.724
001 047 060002 00 00	120X60 MM PRİZ MONTAJ ÇERV.İKİLİ	20	ad.	2.961
001 047 060003 00 00	120X60 MM PRİZ MONTAJ ÇERV.ÜÇLÜ	20	ad.	3.554
001 044 120060 00 00	120X60 MM UÇ TAPA	20	ad.	1.442
001 043 120060 00 00	120X60 MM EK PARÇA	50	ad.	1.066
SİDEM SERİSİ RENKLİ KABLO KANALLARI				
001 007 010008 20 01	10X8 MM KABLO KANALI (SİDEM)	330	mt.	1.304
001 007 012012 20 01	12X12 MM KABLO KANALI (SİDEM)	250	mt.	1.352
001 007 015010 20 01	15X10 MM KABLO KANALI (SİDEM)	250	mt.	1.389
001 007 016016 20 01	16X16 MM KABLO KANALI (SİDEM)	250	mt.	1.725
001 007 020010 20 01	20X10 MM KABLO KANALI (SİDEM)	200	mt.	1.626
001 007 025016 20 01	25X16 MM KABLO KANALI (SİDEM)	150	mt.	2.215
001 007 025025 20 01	25X25 MM KABLO KANALI (SİDEM)	100	mt.	2.596
001 007 930010 20 01	30X10 MM KABLO KANALI (SİDEM) (BÖLMELİ)	140	mt.	2.470
001 007 930016 20 01	30X16 MM KABLO KANALI (SİDEM) (BÖLMELİ)	140	mt.	2.797
001 007 030025 20 01	30X25 MM KABLO KANALI (SİDEM)	80	mt.	2.949
001 007 040016 20 01	40X16 MM KABLO KANALI (SİDEM)	100	mt.	3.175
001 007 940016 20 01	40X16 MM KABLO KANALI (SİDEM) (BÖLMELİ)	100	mt.	3.255
001 007 040025 20 01	40X25 MM KABLO KANALI (SİDEM)	80	mt.	3.510
001 007 040040 20 01	40X40 MM KABLO KANALI (SİDEM)	50	mt.	4.448
001 007 960025 20 01	60X25 MM KABLO KANALI (SİDEM) (BÖLMELİ)	40	mt.	6.057
001 007 060040 20 01	60X40 MM KABLO KANALI (SİDEM)	40	mt.	6.582
001 007 060060 20 01	60X60 MM KABLO KANALI (SİDEM)	32	mt.	7.875
001 007 974020 20 01	74X20 MM KABLO KANALI (SİDEM) (BÖLMELİ)	50	mt.	7.484
001 007 975022 20 01	75X22 MM KABLO KANALI (SİDEM) (BÖLMELİ)	50	mt.	9.177
001 007 080040 20 01	80X40 MM KABLO KANALI (SİDEM)	30	mt.	9.297
001 007 080060 20 01	80X60 MM KABLO KANALI (SİDEM)	24	mt.	10.502
001 007 100036 20 01	100X36 MM KABLO KANALI (SİDEM)	30	mt.	14.012
001 007 100040 20 01	100X40 MM KABLO KANALI (SİDEM)	24	mt.	14.642
001 007 100048 20 01	100X48 MM KABLO KANALI (SİDEM)	24	mt.	15.511
001 007 100060 20 01	100X60 MM KABLO KANALI (SİDEM)	20	mt.	17.510
001 007 075060 20 01	75X60 MM KLİMA KANALI (SİDEM)	30	mt.	12.269
001 007 100037 20 01	100X37 MM KABLO KANALI(SİDEM)(I.KAPAKLI)	30	mt.	14.012
001 007 100050 20 01	100X50 MM KABLO KANALI(SİDEM)(I.KAPAKLI)	20	mt.	15.511
001 007 110060 20 01	110X60 MM KABLO KANALI(SİDEM)(I.KAPAKLI)	20	mt.	26.593
001 007 120060 20 01	120X60 MM KABLO KANALI(SİDEM)(I.KAPAKLI)	16	mt.	18.540
001 007 120070 20 01	120X70 MM KABLO KANALI(SİDEM)	16	mt.	31.802
001 007 170070 20 01	170X70 MM KABLO KANALI(SİDEM)	12	mt.	32.960

Ürün Kodu	Açıklama / Stok Cinsi	Ambalaj (Kutulu)	Ambalaj Birimi	TL
SİDEM SERİSİ RENKLİ KABLO KANALLARI (YAPIŞKANLI)				
001 155 010008 20 01	10X8 MM KABLO KANALI (SİDEM) YAPIŞKANLI	330	mt.	1.566
001 155 012012 20 01	12X12 MM KABLO KANALI (SİDEM) YAPIŞKANLI	250	mt.	1.622
001 155 015010 20 01	15X10 MM KABLO KANALI (SİDEM) YAPIŞKANLI	250	mt.	1.667
001 155 016016 20 01	16X16 MM KABLO KANALI (SİDEM) YAPIŞKANLI	250	mt.	2.070
001 155 020010 20 01	20X10 MM KABLO KANALI (SİDEM) YAPIŞKANLI	180	mt.	1.952
001 155 025016 20 01	25X16 MM KABLO KANALI (SİDEM) YAPIŞKANLI	140	mt.	2.884
001 155 025025 20 01	25X25 MM KABLO KANALI (SİDEM) YAPIŞKANLI	100	mt.	3.115
001 155 930010 20 01	30X10 MM KABLO KANALI (SİDEM) YAPIŞKANLI	140	mt.	2.964
001 155 930016 20 01	30X16 MM KABLO KANALI (SİDEM) YAPIŞKANLI	140	mt.	3.357
001 155 030025 20 01	30X25 MM KABLO KANALI (SİDEM) YAPIŞKANLI	80	mt.	3.811
001 155 040016 20 01	40X16 MM KABLO KANALI (SİDEM) YAPIŞKANLI	100	mt.	3.811
001 155 040025 20 01	40X25 MM KABLO KANALI (SİDEM) YAPIŞKANLI	80	mt.	4.532
001 155 040040 20 01	40X40 MM KABLO KANALI (SİDEM) YAPIŞKANLI	50	mt.	5.459
001 155 960025 20 01	60X25 MM KABLO KANALI (SİDEM) YAPIŞKANLI	40	mt.	7.268
001 155 060015 20 01	60X15 MM KABLO KANALI (SİDEM) YAPIŞKANLI	50	mt.	6.798
001 155 070018 20 01	75X18 MM KABLO KANALI (SİDEM) YAPIŞKANLI	40	mt.	8.896
001 155 060040 20 01	60X40 MM KABLO KANALI (SİDEM) YAPIŞKANLI	40	mt.	9.023

Ürün Kodu	Açıklama / Stok Cinsi	Ambalaj (Kutulu)	Ambalaj Birimi	TL
SİDEM SERİSİ SÜPÜRGELİKLER VE AKSESUARLARI				
001 007 060015 20 01	60X15 MM BALIK SIRTI KANAL (SİDEM)	80	mt.	5.665
001 031 060015 00 01	60X15 MM BALIK SIRTI KANAL L KÖŞE(SİDEM)	1	ad.	2.537
001 032 060015 00 01	60X15 MM BALIK SIRTI EK PARÇASI(SİDEM)	1	ad.	0.841
001 033 060015 00 01	60X15 MM BALIKSIRTI SONLAMAKAPAĞI(SİDEM)	1	ad.	1.019
001 030 060015 00 01	60X15 MM BALIKSIRTI T KÖŞE (SİDEM)	1	ad.	2.537
001 007 070018 20 01	75X18 MM BALIK SIRTI KANAL (SİDEM)	60	mt.	7.413
001 007 090020 20 01	90X20 MM BALIK SIRTI KANAL (SİDEM)	40	mt.	13.946

Ürün Kodu	Açıklama / Stok Cinsi	Ambalaj (Kutulu)	Ambalaj Birimi	TL
12X12 KANAL AKSESUARLARI (SİDEM SERİSİ)				
001 028 012012 00 01	12X12 MM (SİDEM) İÇ KÖŞE	1	ad.	0.651
001 029 012012 00 01	12X12 MM (SİDEM) DIŞ KÖŞE	1	ad.	0.651
001 030 012012 00 01	12X12 MM (SİDEM) T KÖŞE	1	ad.	0.651
001 031 012012 00 01	12X12 MM (SİDEM) 90 L KÖŞE	1	ad.	0.651
001 033 012012 00 01	12X12 MM (SİDEM) UÇ TAPA	1	ad.	0.651
001 032 012012 00 01	12X12 MM (SİDEM) EK PARÇASI	1	ad.	0.651

Ürün Kodu	Açıklama / Stok Cinsi	Ambalaj (Kutulu)	Ambalaj Birimi	TL
15X10 KANAL AKSESUARLARI (SİDEM SERİSİ)				
001 028 015010 00 01	15X10 MM (SİDEM) İÇ KÖŞE	1	ad.	0.651
001 029 015010 00 01	15X10 MM (SİDEM) DIŞ KÖŞE	1	ad.	0.651
001 030 015010 00 01	15X10 MM (SİDEM) T KÖŞE	1	ad.	0.651
001 031 015010 00 01	15X10 MM (SİDEM) 90 L KÖŞE	1	ad.	0.651
001 033 015010 00 01	15X10 MM (SİDEM) UÇ TAPA	1	ad.	0.651
001 032 015010 00 01	15X10 MM (SİDEM) EK PARÇASI	1	ad.	0.651

Ürün Kodu	Açıklama / Stok Cinsi	Ambalaj (Kutulu)	Ambalaj Birimi	TL
20X10 KANAL AKSESUARLARI (SİDEM SERİSİ)				
001 028 020010 00 01	20X10 MM (SİDEM) İÇ KÖŞE	1	ad.	0.711
001 029 020010 00 01	20X10 MM (SİDEM) DIŞ KÖŞE	1	ad.	0.711
001 030 020010 00 01	20X10 MM (SİDEM) T KÖŞE	1	ad.	0.711
001 031 020010 00 01	20X10 MM (SİDEM) 90 L KÖŞE	1	ad.	0.711
001 033 020010 00 01	20X10 MM (SİDEM) UÇ TAPA	1	ad.	0.711
001 032 020010 00 01	20X10 MM (SİDEM) EK PARÇASI	1	ad.	0.711

Ürün Kodu	Açıklama / Stok Cinsi	Ambalaj (Kutulu)	Ambalaj Birimi	TL
16X16 KANAL AKSESUARLARI (SİDEM SERİSİ)				
001 028 016016 00 01	16X16 MM (SİDEM) İÇ KÖŞE	1	ad.	0.711
001 029 016016 00 01	16X16 MM (SİDEM) DIŞ KÖŞE	1	ad.	0.711
001 030 016016 00 01	16X16 MM (SİDEM) T KÖŞE	1	ad.	0.711
001 031 016016 00 01	16X16 MM (SİDEM) 90 L KÖŞE	1	ad.	0.711
001 033 016016 00 01	16X16 MM (SİDEM) UÇ TAPA	1	ad.	0.711
001 032 016016 00 01	16X16 MM (SİDEM) EK PARÇASI	1	ad.	0.711

RENK SEÇENEKLERİ



İÇ KÖŞE

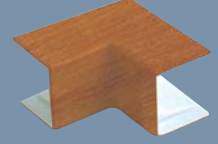

DIŞ KÖŞE

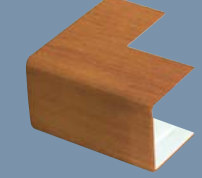

L KÖŞE



T KÖŞE



EK PARÇA



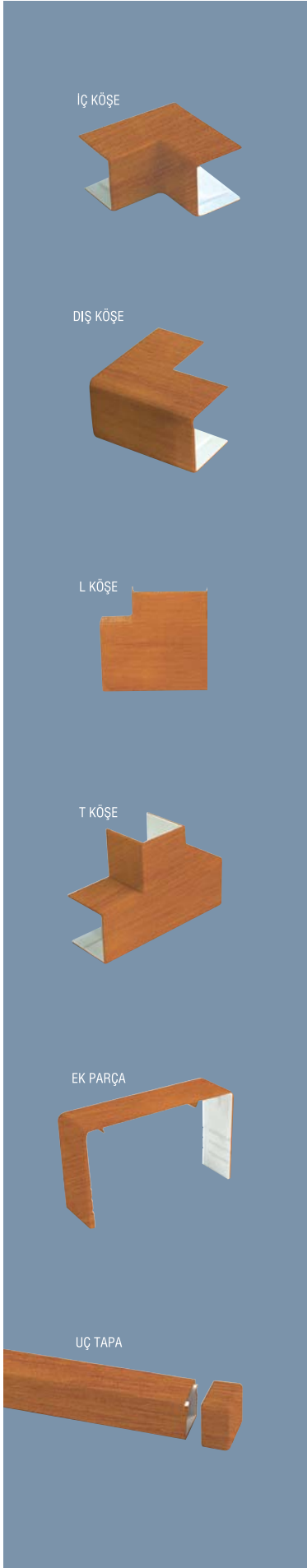

Ürün Kodu	Açıklama / Stok Cinsi	Ambalaj (Kutulu)	CE	Ambalaj Birimi	TL
25X16 KANAL AKSESUARLARI (SİDEM SERİSİ)					
001 028 025016 00 01	25X16 MM (SİDEM) İÇ KÖŞE	1		ad.	0.948
001 029 025016 00 01	25X16 MM (SİDEM) DIŞ KÖŞE	1		ad.	0.948
001 030 025016 00 01	25X16 MM (SİDEM) T KÖŞE	1		ad.	0.948
001 031 025016 00 01	25X16 MM (SİDEM) 90 L KÖŞE	1		ad.	0.948
001 033 025016 00 01	25X16 MM (SİDEM) UÇ TAPA	1		ad.	0.948
001 032 025016 00 01	25X16 MM (SİDEM) EK PARÇA	1		ad.	0.948
001 034 012516 00 01	25X16 MM (SİDEM) P.MONTAJ KASASI	1		ad.	5.014
25X25 KANAL AKSESUARLARI (SİDEM SERİSİ)					
001 030 025025 00 01	25X25 MM (SİDEM) İÇ KÖŞE	1		ad.	0.948
001 029 025025 00 01	25X25 MM (SİDEM) DIŞ KÖŞE	1		ad.	0.948
001 030 025025 00 01	25X25 MM (SİDEM) T PARÇASI	1		ad.	0.948
001 031 025025 00 01	25X25 MM (SİDEM) 90 L KÖŞE	1		ad.	0.948
001 033 025025 00 01	25X25 MM (SİDEM) UÇ TAPA	1		ad.	0.948
001 032 025025 00 01	25X25 MM (SİDEM) EK PARÇA	1		ad.	0.948
001 034 012525 00 01	25X25 MM (SİDEM) P.MONTAJ KASASI	1		ad.	5.014
30X10 KANAL AKSESUARLARI (SİDEM SERİSİ)					
001 028 030010 00 01	30X10 MM (SİDEM) İÇ KÖŞE	1		ad.	1.303
001 029 030010 00 01	30X10 MM (SİDEM) DIŞ KÖŞE	1		ad.	1.303
001 030 030010 00 01	30X10 MM (SİDEM) T PARÇASI	1		ad.	1.303
001 031 030010 00 01	30X10 MM (SİDEM) 90 L KÖŞE	1		ad.	1.303
001 033 030010 00 01	30X10 MM (SİDEM) UÇ TAPA	1		ad.	1.303
001 032 030010 00 01	30X10 MM (SİDEM) EK PARÇA	1		ad.	1.303
30X16 KANAL AKSESUARLARI (SİDEM SERİSİ)					
001 028 030016 00 01	30X16 MM (SİDEM) İÇ KÖŞE	1		ad.	1.303
001 029 030016 00 01	30X16 MM (SİDEM) DIŞ KÖŞE	1		ad.	1.303
001 030 030016 00 01	30X16 MM (SİDEM) T PARÇASI	1		ad.	1.303
001 031 030016 00 01	30X16 MM (SİDEM) 90 L KÖŞE	1		ad.	1.303
001 033 030016 00 01	30X16 MM (SİDEM) UÇ TAPA	1		ad.	1.303
001 032 030016 00 01	30X16 MM (SİDEM) EK PARÇA	1		ad.	1.303
30X25 KANAL AKSESUARLARI (SİDEM SERİSİ)					
001 028 030025 00 01	30X25 MM (SİDEM) İÇ KÖŞE	1		ad.	1.303
001 029 030025 00 01	30X25 MM (SİDEM) DIŞ KÖŞE	1		ad.	1.303
001 030 030025 00 01	30X25 MM (SİDEM) T PARÇASI	1		ad.	1.303
001 031 030025 00 01	30X25 MM (SİDEM) 90 L KÖŞE	1		ad.	1.303
001 033 030025 00 01	30X25 MM (SİDEM) UÇ TAPA	1		ad.	1.303
001 032 030025 00 01	30X25 MM (SİDEM) EK PARÇA	1		ad.	1.303
40X16 KANAL AKSESUARLARI (SİDEM SERİSİ)					
001 028 040016 00 01	40X16 MM (SİDEM) İÇ KÖŞE	1		ad.	1.599
001 029 040016 00 01	40X16 MM (SİDEM) DIŞ KÖŞE	1		ad.	1.599
001 030 040016 00 01	40X16 MM (SİDEM) T KÖŞE	1		ad.	1.599
001 031 040016 00 01	40X16 MM (SİDEM) 90 L KÖŞE	1		ad.	1.599
001 033 040016 00 01	40X16 MM (SİDEM) UÇ TAPA	1		ad.	1.599
001 032 040016 00 01	40X16 MM (SİDEM) EK PARÇASI	1		ad.	1.599
001 034 014016 00 01	40X16 MM (SİDEM) P.MONTAJ KASASI	1		ad.	5.093
40X25 KANAL AKSESUARLARI (SİDEM SERİSİ)					
001 028 040025 00 01	40X25 MM (SİDEM) İÇ KÖŞE	1		ad.	1.599
001 029 040025 00 01	40X25 MM (SİDEM) DIŞ KÖŞE	1		ad.	1.599
001 030 040025 00 01	40X25 MM (SİDEM) T KÖŞE	1		ad.	1.599
001 031 040025 00 01	40X25 MM (SİDEM) 90 L KÖŞE	1		ad.	1.599
001 033 040025 00 01	40X25 MM (SİDEM) UÇ TAPA	1		ad.	1.599
001 032 040025 00 01	40X25 MM (SİDEM) EK PARÇASI	1		ad.	1.599
001 034 014025 00 01	40X25 MM (SİDEM) P.MONTAJ KASASI	1		ad.	5.093
40X40 KANAL AKSESUARLARI (SİDEM SERİSİ)					
001 028 040040 00 01	40X40 MM (SİDEM) İÇ KÖŞE	1		ad.	1.599
001 029 040040 00 01	40X40 MM (SİDEM) DIŞ KÖŞE	1		ad.	1.599
001 030 040040 00 01	40X40 MM (SİDEM) T PARÇASI	1		ad.	1.599
001 031 040040 00 01	40X40 MM (SİDEM) 90 L KÖŞE	1		ad.	1.599
001 033 040040 00 01	40X40 MM (SİDEM) UÇ TAPA	1		ad.	1.599
001 032 040040 00 01	40X40 MM (SİDEM) EK PARÇA	1		ad.	1.599
001 034 014040 00 01	40X40 MM (SİDEM) P.MONTAJ KASASI	1		ad.	5.093

Ürün Kodu	Açıklama / Stok Cinsi	Ambalaj (Kutulu)	Ambalaj Birimi	TL
74X20 KANAL AKSESUARLARI (SİDEM SERİSİ)				
		TS	CE	IP40
001 028 074020 00 01	74X20 MM (SİDEM) İÇ KÖŞE	1	ad.	1.777
001 029 074020 00 01	74X20 MM (SİDEM) DIŞ KÖŞE	1	ad.	1.777
001 030 074020 00 01	74X20 MM (SİDEM) T PARÇASI	1	ad.	1.777
001 031 074020 00 01	74X20 MM (SİDEM) 90 L KÖŞE	1	ad.	1.777
001 033 074020 00 01	74X20 MM (SİDEM) UÇ TAPA	1	ad.	1.777
001 032 074020 00 01	74X20 MM (SİDEM) EK PARÇA	1	ad.	1.777
001 034 017420 00 01	74X20 MM (SİDEM) P.MONTAJ KASASI	1	ad.	5.093
001 034 017421 00 01	74X20 MM (SİDEM) P.MON.KASASI(45X45)	1	ad.	6.515
75X22 KANAL AKSESUARLARI (SİDEM SERİSİ)				
		TS	CE	IP40
001 028 075022 00 01	75X22 MM (SİDEM) İÇ KÖŞE	1	ad.	2.132
001 029 075022 00 01	75X22 MM (SİDEM) DIŞ KÖŞE	1	ad.	2.132
001 033 075022 01 01	75X22 MM (SİDEM) SAĞ SONLAMA	1	ad.	2.132
001 033 075022 02 01	75X22 MM (SİDEM) SOL SONLAMA	1	ad.	2.132
001 032 075022 00 01	75X22 MM (SİDEM) EK PARÇASI	1	ad.	2.132
60X25 KANAL AKSESUARLARI (SİDEM SERİSİ)				
		TS	CE	IP40
001 028 060025 00 01	60X25 MM (SİDEM) İÇ KÖŞE	1	ad.	3.909
001 029 060025 00 01	60X25 MM (SİDEM) DIŞ KÖŞE	1	ad.	3.909
001 030 060025 00 01	60X25 MM (SİDEM) T PARÇASI	1	ad.	3.909
001 031 060025 00 01	60X25 MM (SİDEM) 90 L KÖŞE	1	ad.	3.909
001 033 060025 00 01	60X25 MM (SİDEM) UÇ TAPA	1	ad.	1.540
001 032 060025 00 01	60X25 MM (SİDEM) EK PARÇA	1	ad.	1.185
60X40 KANAL AKSESUARLARI (SİDEM SERİSİ)				
		TS	CE	IP40
001 028 060040 00 01	60X40 MM (SİDEM) İÇ KÖŞE	1	ad.	3.909
001 029 060040 00 01	60X40 MM (SİDEM) DIŞ KÖŞE	1	ad.	3.909
001 030 060040 00 01	60X40 MM (SİDEM) T PARÇASI	1	ad.	3.909
001 031 060040 00 01	60X40 MM (SİDEM) 90 L KÖŞE	1	ad.	3.909
001 033 060040 00 01	60X40 MM (SİDEM) UÇ TAPA	1	ad.	1.540
001 032 060040 00 01	60X40 MM (SİDEM) EK PARÇA	1	ad.	1.185
60X60 KANAL AKSESUARLARI (SİDEM SERİSİ)				
		TS	CE	IP40
001 028 060060 00 01	60X60 MM (SİDEM) İÇ KÖŞE	1	ad.	3.909
001 029 060060 00 01	60X60 MM (SİDEM) DIŞ KÖŞE	1	ad.	3.909
001 030 060060 00 01	60X60 MM (SİDEM) T PARÇASI	1	ad.	3.909
001 031 060060 00 01	60X60 MM (SİDEM) 90 L KÖŞE	1	ad.	3.909
001 033 060060 00 01	60X60 MM (SİDEM) UÇ TAPA	1	ad.	1.540
001 032 060060 00 01	60X60 MM (SİDEM) EK PARÇA	1	ad.	1.185
80X40 KANAL AKSESUARLARI (SİDEM SERİSİ)				
		TS	CE	IP40
001 028 080040 00 01	80X40 MM (SİDEM) İÇ KÖŞE	1	ad.	4.264
001 029 080040 00 01	80X40 MM (SİDEM) DIŞ KÖŞE	1	ad.	4.264
001 030 080040 00 01	80X40 MM (SİDEM) T PARÇASI	1	ad.	4.264
001 031 080040 00 01	80X40 MM (SİDEM) 90 L KÖŞE	1	ad.	4.264
001 033 080040 00 01	80X40 MM (SİDEM) UÇ TAPA	1	ad.	1.540
001 032 080040 00 01	80X40 MM (SİDEM) EK PARÇA	1	ad.	1.185
80X60 KANAL AKSESUARLARI (SİDEM SERİSİ)				
		TS	CE	IP40
001 028 080060 00 01	80X60 MM (SİDEM) İÇ KÖŞE	1	ad.	4.383
001 029 080060 00 01	80X60 MM (SİDEM) DIŞ KÖŞE	1	ad.	4.383
001 030 080060 00 01	80X60 MM (SİDEM) T PARÇASI	1	ad.	4.383
001 031 080060 00 01	80X60 MM (SİDEM) 90 L KÖŞE	1	ad.	4.383
001 033 080060 00 01	80X60 MM (SİDEM) UÇ TAPA	1	ad.	1.540
001 032 080060 00 01	80X60 MM (SİDEM) EK PARÇA	1	ad.	1.185
100X37 KANAL AKSESUARLARI (SİDEM SERİSİ)				
		TS	CE	IP40
001 028 100037 00 01	100X37 MM (SİDEM) İÇ KÖŞE (SABİT)	1	ad.	4.620
001 029 100037 00 01	100X37 MM (SİDEM) DIŞ KÖŞE (SABİT)	1	ad.	4.620
001 028 100037 01 01	100X37 MM (SİDEM) İÇ KÖŞE (HAREKETLİ)	1	ad.	4.620
001 029 100037 01 01	100X37 MM (SİDEM) DIŞ KÖŞE (HAREKETLİ)	1	ad.	4.620
001 030 100037 00 01	100X37 MM (SİDEM) T PARÇASI	1	ad.	4.620
001 031 100037 00 01	100X37 MM (SİDEM) 90 L KÖŞE	1	ad.	4.620
001 033 100037 00 01	100X37 MM (SİDEM) UÇ TAPA	1	ad.	1.540
001 032 100037 00 01	100X37 MM (SİDEM) EK PARÇA	1	ad.	1.185

İÇ KÖŞE

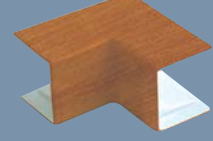

DIŞ KÖŞE

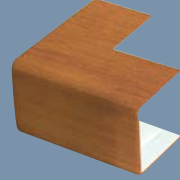

L KÖŞE



T KÖŞE



EK PARÇA



UÇ TAPA





Ürün Kodu	Açıklama / Stok Cinsi	Ambalaj (Kutulu)	Ambalaj Birimi	TL
100X36 KANAL AKSESUARLARI (SİDEM SERİSİ)				
		TS	CE	IP40
001 028 100036 00 01	100X36 MM (SİDEM) İÇ KÖŞE (SABİT)	1	ad.	4.620
001 029 100036 00 01	100X36 MM (SİDEM) DIŞ KÖŞE (SABİT)	1	ad.	4.620
001 028 100036 01 01	100X36 MM (SİDEM) İÇ KÖŞE (HAREKETLİ)	1	ad.	4.620
001 029 100036 01 01	100X36 MM (SİDEM) DIŞ KÖŞE (HAREKETLİ)	1	ad.	4.620
001 030 100036 00 01	100X36 MM (SİDEM) T PARÇASI	1	ad.	4.620
001 031 100036 00 01	100X36 MM (SİDEM) 90 L KÖŞE	1	ad.	4.620
001 033 100036 00 01	100X36 MM (SİDEM) UÇ TAPA	1	ad.	1.540
001 032 100036 00 01	100X36 MM (SİDEM) EK PARÇA	1	ad.	1.185
100X40 KANAL AKSESUARLARI (SİDEM SERİSİ)				
		TS	CE	IP40
001 028 100040 00 01	100X40 MM (SİDEM) İÇ KÖŞE (SABİT)	1	ad.	4.620
001 029 100040 00 01	100X40 MM (SİDEM) DIŞ KÖŞE (SABİT)	1	ad.	4.620
001 028 100040 01 01	100X40 MM (SİDEM) İÇ KÖŞE (HAREKETLİ)	1	ad.	4.620
001 029 100040 01 01	100X40 MM (SİDEM) DIŞ KÖŞE (HAREKETLİ)	1	ad.	4.620
001 030 100040 00 01	100X40 MM (SİDEM) T PARÇASI	1	ad.	4.620
001 031 100040 00 01	100X40 MM (SİDEM) 90 L KÖŞE	1	ad.	4.620
001 033 100040 00 01	100X40 MM (SİDEM) UÇ TAPA	1	ad.	1.540
001 032 100040 00 01	100X40 MM (SİDEM) EK PARÇA	1	ad.	1.185
100X48 KANAL AKSESUARLARI (SİDEM SERİSİ)				
		TS	CE	IP40
001 028 100048 00 01	100X48 MM (SİDEM) İÇ KÖŞE (SABİT)	1	ad.	4.620
001 029 100048 00 01	100X48 MM (SİDEM) DIŞ KÖŞE (SABİT)	1	ad.	4.620
001 028 100048 01 01	100X48 MM (SİDEM) İÇ KÖŞE (HAREKETLİ)	1	ad.	4.620
001 029 100048 01 01	100X48 MM (SİDEM) DIŞ KÖŞE (HAREKETLİ)	1	ad.	4.620
001 030 100048 00 01	100X48 MM (SİDEM) T PARÇASI	1	ad.	4.620
001 031 100048 00 01	100X48 MM (SİDEM) 90 L KÖŞE	1	ad.	4.620
001 033 100048 00 01	100X48 MM (SİDEM) UÇ TAPA	1	ad.	1.540
001 032 100048 00 01	100X48 MM (SİDEM) EK PARÇA	1	ad.	1.185
100X37/50 İÇİN KANAL AKSESUARLARI (SİDEM SERİSİ)				
		TS	CE	IP40
001 034 400001 00 01	100X37/50 İÇİN (SİDEM)45X45 P.M.S.TEKLİ	1	ad.	3.909
001 034 400002 00 01	100X37/50 İÇİN (SİDEM)45X45P.M.S.İKİLİ	1	ad.	4.738
001 034 400003 00 01	100X37/50 İÇİN (SİDEM)45X45 P.M.S.ÜÇLÜ	1	ad.	5.923
001 034 400004 00 01	100X37/50 İÇİN (SİDEM)45X45P.M.S.DÖRTLÜ	1	ad.	7.107
001 034 500001 00 01	100X37/50 İÇİN (SİDEM)55X55P.M.S.TEKLİ	1	ad.	3.909
001 034 500002 00 01	100X37/50 İÇİN (SİDEM)55X55P.M.S.İKİLİ	1	ad.	4.738
001 034 500003 00 01	100X37/50 İÇİN (SİDEM)55X55P.M.S.ÜÇLÜ	1	ad.	5.923
001 034 500004 00 01	100X37/50 İÇİN (SİDEM)55X55P.M.S.DÖRTLÜ	1	ad.	7.622
100X50 KANAL AKSESUARLARI (SİDEM SERİSİ)				
		TS	CE	IP40
001 028 100050 00 01	100X50 MM (SİDEM) İÇ KÖŞE (SABİT)	1	ad.	4.620
001 029 100050 00 01	100X50 MM (SİDEM) DIŞ KÖŞE (SABİT)	1	ad.	4.620
001 028 100050 01 01	100X50 MM (SİDEM) İÇ KÖŞE (HAREKETLİ)	1	ad.	4.620
001 029 100050 01 01	100X50 MM (SİDEM) DIŞ KÖŞE (HAREKETLİ)	1	ad.	4.620
001 030 100050 00 01	100X50 MM (SİDEM) T PARÇASI	1	ad.	4.620
001 031 100050 00 01	100X50 MM (SİDEM) 90 L KÖŞE	1	ad.	4.620
001 033 100050 00 01	100X50 MM (SİDEM) UÇ TAPA	1	ad.	1.540
001 032 100050 00 01	100X50 MM (SİDEM) EK PARÇA	1	ad.	1.185
100X60 KANAL AKSESUARLARI (SİDEM SERİSİ)				
		TS	CE	IP40
001 028 100060 00 01	100X60 MM (SİDEM) İÇ KÖŞE (SABİT)	1	ad.	4.620
001 029 100060 00 01	100X60 MM (SİDEM) DIŞ KÖŞE (SABİT)	1	ad.	4.620
001 028 100060 01 01	100X60 MM (SİDEM) İÇ KÖŞE (HAREKETLİ)	1	ad.	4.620
001 029 100060 01 01	100X60 MM (SİDEM) DIŞ KÖŞE (HAREKETLİ)	1	ad.	4.620
001 030 100060 00 01	100X60 MM (SİDEM) T PARÇASI	1	ad.	4.620
001 031 100060 00 01	100X60 MM (SİDEM) 90 L KÖŞE	1	ad.	4.620
001 033 100060 00 01	100X60 MM (SİDEM) UÇ TAPA	1	ad.	1.540
001 032 100060 00 01	100X60 MM (SİDEM) EK PARÇA	1	ad.	1.185
100'LÜK SERİ PRİZ MONTAJ SETLERİ (55X55 İÇİN) (SİDEM SERİSİ)				
		TS	CE	IP40
001 034 000001 00 01	100'LÜK SERİ 55X55 P.M.S.TEKLİ SİDEM	1	ad.	3.909
001 034 000002 00 01	100'LÜK SERİ 55X55 P.M.S.İKİLİ SİDEM	1	ad.	4.738
001 034 000003 00 01	100'LÜK SERİ 55X55 P.M.S.ÜÇLÜ SİDEM	1	ad.	5.923
100'LÜK SERİ PRİZ MONTAJ SETLERİ (45X45 İÇİN) (SİDEM)				
001 034 100001 00 01	100'LÜK SERİ 45X45 P.M.S.TEKLİ SİDEM	1	ad.	3.909
001 034 100002 00 01	100'LÜK SERİ 45X45 P.M.S.İKİLİ SİDEM	1	ad.	4.738
001 034 100003 00 01	100'LÜK SERİ 45X45 P.M.S.ÜÇLÜ SİDEM	1	ad.	5.923
001 034 100004 00 01	100'LÜK SERİ 45X45 P.M.S.DÖRTLÜ SİDEM	1	ad.	7.107
120X60 KANAL AKSESUARLARI (SİDEM SERİSİ)				
		TS	CE	IP40
001 028 120060 00 01	120X60 MM (SİDEM) İÇ KÖŞE	1	ad.	5.923
001 029 120060 00 01	120X60 MM (SİDEM) DIŞ KÖŞE	1	ad.	5.923
001 030 120060 00 01	120X60 MM (SİDEM) T PARÇA	1	ad.	5.923
001 031 120060 00 01	120X60 MM (SİDEM) 90 L KÖŞE	1	ad.	5.923
001 034 300001 00 01	120X60 MM (SİDEM) P.MONTAJ ÇERV.TEKLİ	1	ad.	3.914
001 034 300002 00 01	120X60 MM (SİDEM) P.MONTAJ ÇERV.İKİLİ	1	ad.	5.330
001 034 300003 00 01	120X60 MM (SİDEM) P.MONTAJ ÇERV.ÜÇLÜ	1	ad.	5.923
001 033 120060 00 01	120X60 MM (SİDEM) UÇ TAPA	1	ad.	1.303
001 032 120060 00 01	120X60 MM (SİDEM) EK PARÇA	1	ad.	1.303

Ürün Kodu	Açıklama / Stok Cinsi	Ambalaj (Kutulu)	Ambalaj Birimi	TL
KABLO TOPLAMA SİRALLI				
888 020 900003	R1034 16 MM KAB.TOP SPR.(1,5M VAK. AMB.)	1	ad.	4.00 USD.
888 020 900006	R1035 22 MM KAB.TOP SPR.(1,5M VAK. AMB.)	1	ad.	6.00 USD.
888 020 900009	R1036 28 MM KAB.TOP SPR.(1,5M VAK. AMB.)	1	ad.	7.40 USD.
888 020 900001	R1033 10 MM KAB.TOP SPR. (25M RULO AMB.)	25	mt.	2.50 USD.
888 020 900004	R1034 16 MM KAB.TOP SPR. (25M RULO AMB.)	25	mt.	3.60 USD.
888 020 900007	R1035 22 MM KAB.TOP SPR. (25M RULO AMB.)	25	mt.	5.00 USD.
888 020 900010	R1036 28 MM KAB.TOP SPR. (25M RULO AMB.)	25	mt.	6.50 USD.
888 020 900011	R1037 34 MM KAB.TOP SPR. (25M RULO AMB.)	25	mt.	9.00 USD.
888 020 900002	R1034 16 MM KAB.TOP SPR. AKSESUARİ	1	ad.	0.44 USD.
888 020 900005	R1035 22 MM KAB.TOP SPR. AKSESUARİ	1	ad.	0.587 USD.
888 020 900008	R1036 28 MM KAB.TOP SPR. AKSESUARİ	1	ad.	0.697 USD.

PLASTİK SİRALLER (SİYAH)					
001 020 400011 00 11	11 Q PLASTİK SİRALLER (SİYAH)	—	100	mt.	0.283
001 020 400014 00 11	14 Q PLASTİK SİRALLER (SİYAH)	—	100	mt.	0.283
001 020 400016 00 11	16 Q PLASTİK SİRALLER (SİYAH)	☞☞	100	mt.	0.412
001 020 400018 00 11	18 Q PLASTİK SİRALLER (SİYAH)	☞☞	50	mt.	0.412
001 020 400020 00 11	20 Q PLASTİK SİRALLER (SİYAH)	☞☞	50	mt.	0.412
001 020 400026 00 11	26 Q PLASTİK SİRALLER (SİYAH)	☞☞	50	mt.	0.567
001 020 400032 00 11	32 Q PLASTİK SİRALLER (SİYAH)	☞☞	50	mt.	0.773
001 020 400040 00 11	40 Q PLASTİK SİRALLER (SİYAH)	☞☞	25	mt.	1.007
001 020 400050 00 11	50 Q PLASTİK SİRALLER (SİYAH)	—	25	mt.	1.303

PLASTİK SİRALLER (SİYAH) (TELLİ)					
001 020 410014 00 11	14 Q PLASTİK SİRALLER (SİYAH) TELLİ	—	100	mt.	0.361
001 020 410016 00 11	16 Q PLASTİK SİRALLER (SİYAH) TELLİ	☞☞	100	mt.	0.464
001 020 410018 00 11	18 Q PLASTİK SİRALLER (SİYAH) TELLİ	☞☞	50	mt.	0.515
001 020 410020 00 11	20 Q PLASTİK SİRALLER (SİYAH) TELLİ	☞☞	50	mt.	0.515

PLASTİK SİRALLER (RENKLİ)					
001 020 400011 00 00	11 Q PLS. SİRALLER (GRI - BYZ - KIR - MAVİ)	—	100	mt.	0.438
001 020 400014 00 00	14 Q PLS. SİRALLER (GRI - BYZ - KIR - MAVİ)	—	100	mt.	0.438
001 020 400016 00 00	16 Q PLS. SİRALLER (GRI - BYZ - KIR - MAVİ)	☞☞	100	mt.	0.567
001 020 400018 00 00	18 Q PLS. SİRALLER (GRI - BYZ - KIR - MAVİ)	☞☞	50	mt.	0.610
001 020 400020 00 00	20 Q PLS. SİRALLER (GRI - BYZ - KIR - MAVİ)	☞☞	50	mt.	0.610
001 020 400026 00 00	26 Q PLS. SİRALLER (GRI - BYZ - KIR - MAVİ)	☞☞	50	mt.	0.773
001 020 400032 00 00	32 Q PLS. SİRALLER (GRI - BYZ - KIR - MAVİ)	☞☞	50	mt.	1.288
001 020 400040 00 00	40 Q PLS. SİRALLER (GRI - BYZ - KIR - MAVİ)	☞☞	25	mt.	1.231
001 020 400050 00 00	50 Q PLS. SİRALLER (GRI - BYZ - KIR - MAVİ)	—	25	mt.	2.163
001 020 990016 00 17	16MM SİRALLER EK MUFU (GRI)	—	200	ad.	0.180
001 020 990020 00 17	20MM SİRALLER EK MUFU (GRI)	—	200	ad.	0.202
001 020 990025 00 17	25MM SİRALLER EK MUFU (GRI)	—	100	ad.	0.231
001 020 990032 00 17	32MM SİRALLER EK MUFU (GRI)	—	200	ad.	0.268

PP POLYPROPİLEN SİRALLER					
001 020 160007 00 11	MUT/PP-7 PP POLYPROPİLEN SİRALLER BORU	—	100	mt.	0.321
001 020 160009 00 11	MUT/PP-8,5 PP POLYPROPİLEN SİRALLER BORU	—	100	mt.	0.381
001 020 160010 00 11	MUT/PP-10 PP POLYPROPİLEN SİRALLER BORU	—	100	mt.	0.421
001 020 160012 00 11	MUT/PP-12 PP POLYPROPİLEN SİRALLER BORU	—	50	mt.	0.461
001 020 160014 00 11	MUT/PP-14 PP POLYPROPİLEN SİRALLER BORU	—	50	mt.	0.601
001 020 160017 00 11	MUT/PP-17 PP POLYPROPİLEN SİRALLER BORU	—	50	mt.	0.661
001 020 160019 00 11	MUT/PP-19 PP POLYPROPİLEN SİRALLER BORU	—	50	mt.	0.821
001 020 160023 00 11	MUT/PP-23 PP POLYPROPİLEN SİRALLER BORU	—	50	mt.	0.982
001 020 160026 00 11	MUT/PP-26 PP POLYPROPİLEN SİRALLER BORU	—	25	mt.	1.042
001 020 160029 00 11	MUT/PP-29 PP POLYPROPİLEN SİRALLER BORU	—	25	mt.	1.102
001 020 160036 00 11	MUT/PP-36 PP POLYPROPİLEN SİRALLER BORU	—	25	mt.	1.422
001 020 160048 00 11	MUT/PP-48 PP POLYPROPİLEN SİRALLER BORU	—	25	mt.	1.703

PA6 POLYAMİD SİRALLER (YANMAZ (-30+125))					
001 020 170007 00 11	MUT/PA6-7 POLYAMİD SİRALLER BORU (ALEV YAYMAYAN)	—	100	mt.	0.704
001 020 170009 00 11	MUT/PA6-8,5 POLYAMİD SİRALLER BORU (ALEV YAYMAYAN)	—	100	mt.	0.780
001 020 170010 00 11	MUT/PA6-10 POLYAMİD SİRALLER BORU (ALEV YAYMAYAN)	—	100	mt.	0.914
001 020 170012 00 11	MUT/PA6-12 POLYAMİD SİRALLER BORU (ALEV YAYMAYAN)	—	50	mt.	1.313
001 020 170014 00 11	MUT/PA6-14 POLYAMİD SİRALLER BORU (ALEV YAYMAYAN)	—	50	mt.	1.390
001 020 170017 00 11	MUT/PA6-17 POLYAMİD SİRALLER BORU (ALEV YAYMAYAN)	—	50	mt.	1.751
001 020 170019 00 11	MUT/PA6-19 POLYAMİD SİRALLER BORU (ALEV YAYMAYAN)	—	50	mt.	1.942
001 020 170023 00 11	MUT/PA6-23 POLYAMİD SİRALLER BORU (ALEV YAYMAYAN)	—	50	mt.	2.474
001 020 170026 00 11	MUT/PA6-26 POLYAMİD SİRALLER BORU (ALEV YAYMAYAN)	—	25	mt.	2.608
001 020 170029 00 11	MUT/PA6-29 POLYAMİD SİRALLER BORU (ALEV YAYMAYAN)	—	25	mt.	2.836
001 020 170036 00 11	MUT/PA6-36 POLYAMİD SİRALLER BORU (ALEV YAYMAYAN)	—	25	mt.	3.578
001 020 170048 00 11	MUT/PA6-48 POLYAMİD SİRALLER BORU (ALEV YAYMAYAN)	—	25	mt.	5.901

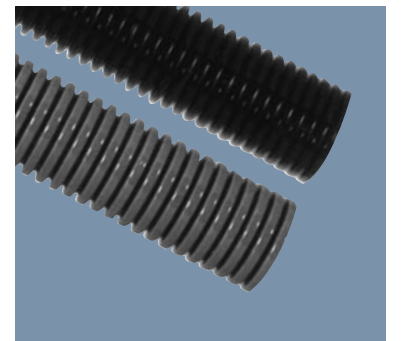
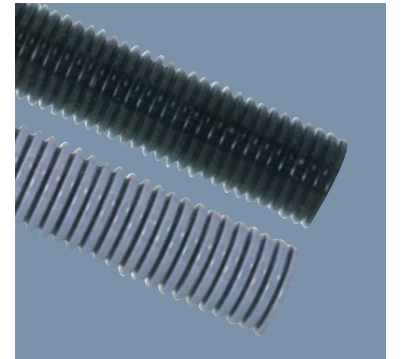
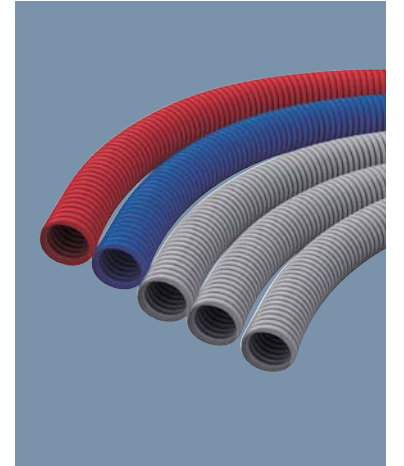
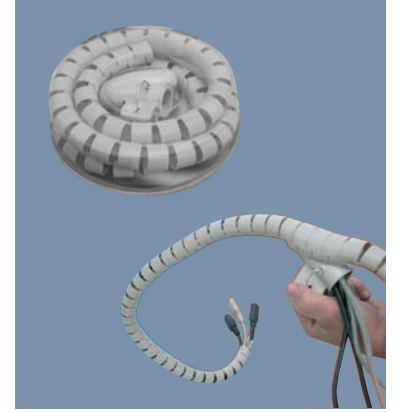

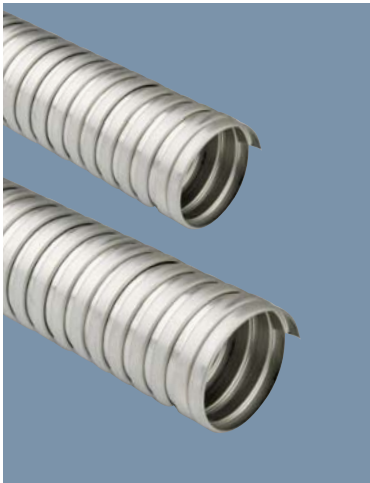
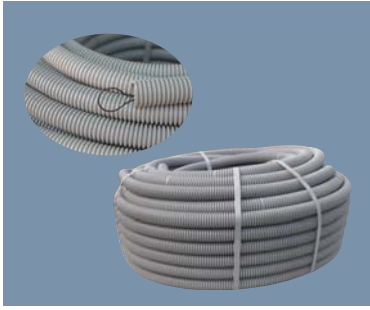
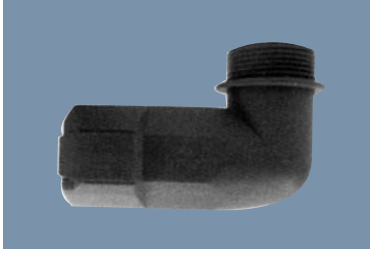

Ürün Kodu	Açıklama / Stok Cinsi	Ambalaj (Kutulu)	Ambalaj Birimi	TL
POLYAMİD SİRAL REKORU				
057 097 110007	PSR-7 POLYAMİD SİRAL REKORU	50	ad.	0.500 EUR.
057 097 110009	PSR-9 POLYAMİD SİRAL REKORU	50	ad.	0.540 EUR.
057 097 110011	PSR-11 POLYAMİD SİRAL REKORU	50	ad.	0.600 EUR.
057 097 110135	PSR-13,5 POLYAMİD SİRAL REKORU	50	ad.	0.680 EUR.
057 097 110016	PSR-16 POLYAMİD SİRAL REKORU	25	ad.	0.800 EUR.
057 097 110021	PSR-21 POLYAMİD SİRAL REKORU	20	ad.	1.500 EUR.
057 097 110029	PSR-29 POLYAMİD SİRAL REKORU	10	ad.	2.300 EUR.
057 097 110036	PSR-36 POLYAMİD SİRAL REKORU	1	ad.	3.280 EUR.
057 097 110048	PSR-48 POLYAMİD SİRAL REKORU	1	ad.	3.940 EUR.

POLYAMİD SİRAL REKORU (90 DERECE DİRSEK)				
057 097 120007	PSRD-7 POLYAMİD SİRAL REKORU 90 DRC.DİRSEK	1	ad.	0.920 EUR.
057 097 120009	PSRD-9 POLYAMİD SİRAL REKORU 90 DRC.DİRSEK	1	ad.	0.980 EUR.
057 097 120011	PSRD-11 POLYAMİD SİRAL REKORU 90 DRC.DİRSEK	1	ad.	1.100 EUR.
057 097 120135	PSRD-13,5 POLYAMİD SİRAL REKORU 90 DRC.DİRSEK	1	ad.	1.250 EUR.
057 097 120016	PSRD-16 POLYAMİD SİRAL REKORU 90 DRC.DİRSEK	1	ad.	1.420 EUR.
057 097 120021	PSRD-21 POLYAMİD SİRAL REKORU 90 DRC.DİRSEK	1	ad.	1.870 EUR.
057 097 120029	PSRD-29 POLYAMİD SİRAL REKORU 90 DRC.DİRSEK	1	ad.	2.950 EUR.
057 097 120036	PSRD-36 POLYAMİD SİRAL REKORU 90 DRC.DİRSEK	1	ad.	3.920 EUR.

PVC. SİRALLER (ALEV YAYMAYAN)				
001 020 000016 00 11	16'LİK ALEV YAYMAYAN SİRALLER (AĞIR SERİ)	100	mt.	0.616
001 020 000020 00 11	20'LİK ALEV YAYMAYAN SİRALLER (AĞIR SERİ)	100	mt.	0.763
001 020 000025 00 11	25'LİK ALEV YAYMAYAN SİRALLER (AĞIR SERİ)	50	mt.	1.171
001 020 000032 00 11	32'LİK ALEV YAYMAYAN SİRALLER (AĞIR SERİ)	50	mt.	1.317

PVC. KLAVUZ TELLİ SİRALLER (ALEV YAYMAYAN)				
001 020 100016 00 11	16'LİK KLAVUZ TELLİ ALEV YAYMAYAN SİRALLER	100	mt.	0.711
001 020 100020 00 11	20'LİK KLAVUZ TELLİ ALEV YAYMAYAN SİRALLER	100	mt.	0.888
001 020 100025 00 11	25'LİK KLAVUZ TELLİ ALEV YAYMAYAN SİRALLER	50	mt.	1.303
001 020 100032 00 11	32'LİK KLAVUZ TELLİ ALEV YAYMAYAN SİRALLER	50	mt.	1.421

HALOJEN FREE SİRALLER (ALEV YAYAN)					
001 020 140016 00 00	16'LİK HALOJEN FREE SPR. (ALEV YAYAN)	TS CE	100	mt.	0.432
001 020 140020 00 00	20'LİK HALOJEN FREE SPR. (ALEV YAYAN)	TS CE	100	mt.	0.519
001 020 140025 00 00	25'LİK HALOJEN FREE SPR. (ALEV YAYAN)	TS CE	50	mt.	0.638
001 020 140032 00 00	32'LİK HALOJEN FREE SPR. (ALEV YAYAN)	TS CE	50	mt.	0.969
001 020 140040 00 00	40'LİK HALOJEN FREE SPR. (ALEV YAYAN)	TS CE	25	mt.	1.540
001 020 140050 00 00	50'LİK HALOJEN FREE SPR. (ALEV YAYAN)	—	25	mt.	2.014

HALOJEN FREE SİRALLER (ALEV YAYMAYAN)					
001 020 150016 00 00	16'LİK HALOJEN FREE SPR. (ALEV YAYMAYAN)	TS CE	100	mt.	0.845
001 020 150020 00 00	20'LİK HALOJEN FREE SPR. (ALEV YAYMAYAN)	TS CE	100	mt.	1.108
001 020 150025 00 00	25'LİK HALOJEN FREE SPR. (ALEV YAYMAYAN)	TS CE	50	mt.	1.386
001 020 150032 00 00	32'LİK HALOJEN FREE SPR. (ALEV YAYMAYAN)	TS CE	50	mt.	1.800
001 020 150040 00 00	40'LİK HALOJEN FREE SPR. (ALEV YAYMAYAN)	TS CE	25	mt.	2.502
001 020 150050 00 00	50'LİK HALOJEN FREE SPR. (ALEV YAYMAYAN)	—	25	mt.	3.003

ÇELİK SİRALLER					
001 054 120009 00 66	9 Q ÇELİK SİRALLER	TS CE	50	mt.	0.790
001 054 120011 00 66	11 Q ÇELİK SİRALLER (3/8")	TS CE	50	mt.	0.855
001 054 120014 00 66	14 Q ÇELİK SİRALLER (1/2")	TS CE	50	mt.	0.932
001 054 120016 00 66	16 Q ÇELİK SİRALLER	—	50	mt.	1.055
001 054 120018 00 66	18 Q ÇELİK SİRALLER (3/4")	TS CE	50	mt.	1.121
001 054 120026 00 66	26 Q ÇELİK SİRALLER (1")	TS CE	25	mt.	1.742
001 054 120029 00 66	29 Q ÇELİK SİRALLER (1 1/4")	—	25	mt.	1.905
001 054 120037 00 66	37 Q ÇELİK SİRALLER (1 1/2")	TS CE	25	mt.	2.525
001 054 120042 00 66	42 Q ÇELİK SİRALLER	—	25	mt.	2.710
001 054 120050 00 66	50 Q ÇELİK SİRALLER (2")	—	25	mt.	3.676

Ürün Kodu	Açıklama / Stok Cinsi	Ambalaj (Kutulu)	Ambalaj Birimi	TL
ÇELİK SİRALLER (KLAVUZ TELLİ)				
001 054 121014 00 66	14 Q ÇELİK SİRALLER (KLAVUZ TELLİ) (1/2")	50	mt.	1.229
001 054 121016 00 66	16 Q ÇELİK SİRALLER (KLAVUZ TELLİ)	50	mt.	1.329
001 054 121018 00 66	18 Q ÇELİK SİRALLER (KLAVUZ TELLİ) (3/4")	50	mt.	1.395
001 054 121026 00 66	26 Q ÇELİK SİRALLER (KLAVUZ TELLİ) (1")	25	mt.	2.013
001 054 121029 00 66	29 Q ÇELİK SİRALLER (KLAVUZ TELLİ) (1 1/4")	25	mt.	2.243
001 054 121037 00 66	37 Q ÇELİK SİRALLER (KLAVUZ TELLİ) (1 1/2")	25	mt.	2.971
001 054 121042 00 66	42 Q ÇELİK SİRALLER (KLAVUZ TELLİ)	25	mt.	3.007
001 054 121050 00 66	50 Q ÇELİK SİRALLER (KLAVUZ TELLİ) (2")	25	mt.	3.949

İZOLELİ ÇELİK SİRALLER				
001 054 130009 00 11	9 Q İZOLELİ ÇELİK SİRALLER	50	mt.	1.536
001 054 130011 00 11	11 Q İZOLELİ ÇELİK SİRALLER (3/8")	50	mt.	1.619
001 054 130014 00 11	14 Q İZOLELİ ÇELİK SİRALLER (1/2")	50	mt.	1.883
001 054 130016 00 11	16 Q İZOLELİ ÇELİK SİRALLER	50	mt.	2.057
001 054 130018 00 11	18 Q İZOLELİ ÇELİK SİRALLER (3/4")	50	mt.	2.183
001 054 130026 00 11	26 Q İZOLELİ ÇELİK SİRALLER (1")	25	mt.	3.139
001 054 130029 00 11	29 Q İZOLELİ ÇELİK SİRALLER (1 1/4")	25	mt.	3.387
001 054 130037 00 11	37 Q İZOLELİ ÇELİK SİRALLER (1 1/2")	25	mt.	4.367
001 054 130042 00 11	42 Q İZOLELİ ÇELİK SİRALLER	25	mt.	4.950
001 054 130050 00 11	50 Q İZOLELİ ÇELİK SİRALLER (2")	25	mt.	6.395

İZOLELİ ÇELİK SİRALLER (KLAVUZ TELLİ)				
001 054 140014 00 11	14 Q İZOLELİ ÇELİK SİRALLER (KLAVUZ TELLİ) (1/2")	50	mt.	2.078
001 054 140016 00 11	16 Q İZOLELİ ÇELİK SİRALLER (KLAVUZ TELLİ)	50	mt.	2.204
001 054 140018 00 11	18 Q İZOLELİ ÇELİK SİRALLER (KLAVUZ TELLİ) (3/4")	50	mt.	2.333
001 054 140026 00 11	26 Q İZOLELİ ÇELİK SİRALLER (KLAVUZ TELLİ) (1")	25	mt.	3.240
001 054 140029 00 11	29 Q İZOLELİ ÇELİK SİRALLER (KLAVUZ TELLİ) (1 1/4")	25	mt.	3.436
001 054 140037 00 11	37 Q İZOLELİ ÇELİK SİRALLER (KLAVUZ TELLİ) (1 1/2")	25	mt.	4.395
001 054 140042 00 11	42 Q İZOLELİ ÇELİK SİRALLER (KLAVUZ TELLİ)	25	mt.	5.150
001 054 140050 00 11	50 Q İZOLELİ ÇELİK SİRALLER (KLAVUZ TELLİ) (2")	25	mt.	6.592

NİKEL KAPLI ÇELİK SİRALLER				
012 097 030009	CLK-9 NİKEL KAPLI ÇELİK SİRALLER	150	ad.	2.975
012 097 030011	CLK-11 NİKEL KAPLI ÇELİK SİRALLER	175	ad.	3.000
012 097 030014	CLK-14 NİKEL KAPLI ÇELİK SİRALLER	90	ad.	3.775
012 097 030016	CLK-16 NİKEL KAPLI ÇELİK SİRALLER	75	ad.	4.725
012 097 030018	CLK-18 NİKEL KAPLI ÇELİK SİRALLER	80	ad.	5.000
012 097 030026	CLK-26 NİKEL KAPLI ÇELİK SİRALLER	30	ad.	11.025
012 097 030037	CLK-37 NİKEL KAPLI ÇELİK SİRALLER	9	ad.	22.050

PİRİNÇ RAKORLAR (KELEPÇELİ)				
012 097 020009	9'LUK PİRİNÇ RAKOR (KELEPÇELİ)	1	ad.	6.500
012 097 020011	11'LİK PİRİNÇ RAKOR (KELEPÇELİ)	1	ad.	7.325
012 097 020135	13.5'LUK PİRİNÇ RAKOR (KELEPÇELİ)	1	ad.	8.225
012 097 020016	16'LUK PİRİNÇ RAKOR (KELEPÇELİ)	1	ad.	9.700
012 097 020021	21'LUK PİRİNÇ RAKOR (KELEPÇELİ)	1	ad.	12.000
012 097 020029	29'LUK PİRİNÇ RAKOR (KELEPÇELİ)	1	ad.	18.100
012 097 020036	36'LUK PİRİNÇ RAKOR (KELEPÇELİ)	1	ad.	27.225
012 097 020042	42'LUK PİRİNÇ RAKOR (KELEPÇELİ)	1	ad.	35.750

PİRİNÇ RAKORLAR (NORMAL)				
012 097 010009	9'LUK PİRİNÇ RAKOR (NORMAL)	1	ad.	3.775
012 097 010011	11'LİK PİRİNÇ RAKOR (NORMAL)	1	ad.	4.475
012 097 010135	13.5'LUK PİRİNÇ RAKOR (NORMAL)	1	ad.	5.150
012 097 010016	16'LUK PİRİNÇ RAKOR (NORMAL)	1	ad.	6.200
012 097 010021	21'LUK PİRİNÇ RAKOR (NORMAL)	1	ad.	8.625
012 097 010029	29'LUK PİRİNÇ RAKOR (NORMAL)	1	ad.	12.000
012 097 010036	36'LUK PİRİNÇ RAKOR (NORMAL)	1	ad.	16.875
012 097 010042	42'LUK PİRİNÇ RAKOR (NORMAL)	1	ad.	19.800

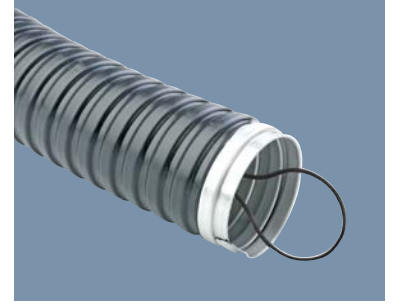
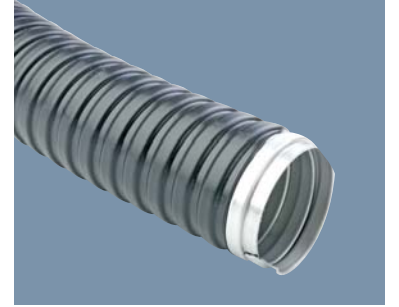

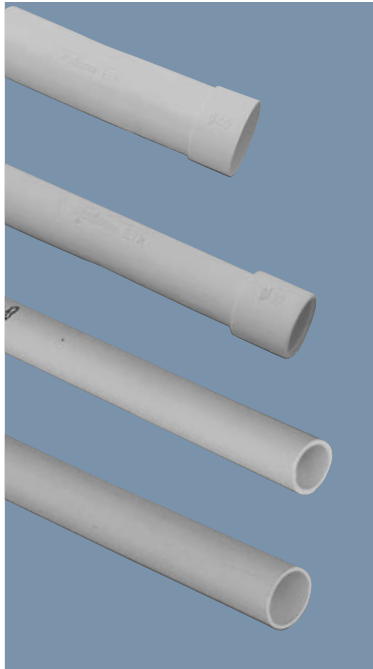

Ürün Kodu	Açıklama / Stok Cinsi	Ambalaj (Kutulu)	Ambalaj Birimi	TL
SÜPER ETANJ PLASTİK RAKORLAR				
010 097 00007	PG-7 SÜPER ETANJ PLASTİK REKOR	450	ad.	0.259
010 097 00009	PG-9 SÜPER ETANJ PLASTİK REKOR	300	ad.	0.288
010 097 00011	PG-11 SÜPER ETANJ PLASTİK REKOR	200	ad.	0.367
010 097 000135	PG-13,5 SÜPER ETANJ PLASTİK REKOR	175	ad.	0.396
010 097 00016	PG-16 SÜPER ETANJ PLASTİK REKOR	125	ad.	0.480
010 097 00021	PG-21 SÜPER ETANJ PLASTİK REKOR	75	ad.	0.672
010 097 00029	PG-29 SÜPER ETANJ PLASTİK REKOR	40	ad.	1.176
010 097 00036	PG-36 SÜPER ETANJ PLASTİK REKOR	20	ad.	2.256
010 097 00042	PG-42 SÜPER ETANJ PLASTİK REKOR	15	ad.	3.072
010 097 00048	PG-48 SÜPER ETANJ PLASTİK REKOR	12	ad.	3.360
PLASTİK RAKOR SOMUNLARI				
010 098 020007	PG-7 SOMUN	250	ad.	0.120
010 098 020009	PG-9 SOMUN	250	ad.	0.144
010 098 020011	PG-11 SOMUN	250	ad.	0.144
010 098 020135	PG-13,5 SOMUN	250	ad.	0.168
010 098 020016	PG-16 SOMUN	250	ad.	0.168
010 098 020021	PG-21 SOMUN	250	ad.	0.216
010 098 020029	PG-29 SOMUN	150	ad.	0.360
010 098 020036	PG-36 SOMUN	100	ad.	0.744
SÜPER ETANJ METAL RAKORLAR				
057 097 100007	PG-7 SÜPER ETANJ METAL REKOR	1	ad.	2.928
057 097 100009	PG-9 SÜPER ETANJ METAL REKOR	1	ad.	3.480
057 097 100011	PG-11 SÜPER ETANJ METAL REKOR	1	ad.	3.840
057 097 100135	PG-13,5 SÜPER ETANJ METAL REKOR	1	ad.	4.464
057 097 100016	PG-16 SÜPER ETANJ METAL REKOR	1	ad.	5.184
057 097 100021	PG-21 SÜPER ETANJ METAL REKOR	1	ad.	8.064
057 097 100029	PG-29 SÜPER ETANJ METAL REKOR	1	ad.	14.520
057 097 100036	PG-36 SÜPER ETANJ METAL REKOR	1	ad.	26.352
057 097 100042	PG-42 SÜPER ETANJ METAL REKOR	1	ad.	36.576
057 097 100048	PG-48 SÜPER ETANJ METAL REKOR	1	ad.	51.000
SİRAL UÇLU ETANJ RAKORLAR				
022 097 060007	PG-7 SİRAL UÇLU ETANJ RAKOR GRİ	100	ad.	0.984
022 097 060009	PG-9 SİRAL UÇLU ETANJ RAKOR GRİ	100	ad.	1.032
022 097 060011	PG-11 SİRAL UÇLU ETANJ RAKOR GRİ	100	ad.	1.284
022 097 060135	PG-13.5 SİRAL UÇLU ETANJ RAKOR GRİ	100	ad.	1.428
022 097 060016	PG-16 SİRAL UÇLU ETANJ RAKOR GRİ	50	ad.	1.824
022 097 060021	PG-21 SİRAL UÇLU ETANJ RAKOR GRİ	50	ad.	2.712
PVC.ALEV YAYMAYAN KENDİNDEN MUFLU BORULAR				
001 045 110014 30 17	14'LÜK PVC.ALEV YAYMAYAN MUFLU BORU (BOY: 3 M.)	102	mt.	1.082
001 045 110016 30 17	16'LİK PVC.ALEV YAYMAYAN MUFLU BORU (BOY: 3 M.)	102	mt.	1.163
001 045 110018 30 17	18'LİK PVC.ALEV YAYMAYAN MUFLU BORU (BOY: 3 M.)	102	mt.	1.173
001 045 110020 30 17	20'LİK PVC.ALEV YAYMAYAN MUFLU BORU (BOY: 3 M.)	102	mt.	1.308
001 045 110025 30 17	25'LİK PVC.ALEV YAYMAYAN MUFLU BORU (BOY: 3 M.)	51	mt.	1.918
001 045 110032 30 17	32'LİK PVC.ALEV YAYMAYAN MUFLU BORU (BOY: 3 M.)	30	mt.	2.650
001 045 110040 30 17	40'LİK PVC.ALEV YAYMAYAN MUFLU BORU (BOY: 3 M.)	30	mt.	3.657
PVC.ALEV YAYMAYAN BORULAR				
001 045 120014 30 17	14'LÜK PVC.ALEV YAYMAYAN BORU (BOY: 3M..)	102	mt.	0.851
001 045 120016 30 17	16'LİK PVC.ALEV YAYMAYAN BORU (BOY: 3M..)	102	mt.	0.858
001 045 120018 30 17	18'LİK PVC.ALEV YAYMAYAN BORU (BOY: 3M..)	102	mt.	0.955
001 045 120020 30 17	20'LİK PVC.ALEV YAYMAYAN BORU (BOY: 3M..)	102	mt.	1.088
001 045 120025 30 17	25'LİK PVC.ALEV YAYMAYAN BORU (BOY: 3M..)	51	mt.	1.550
001 045 120032 30 17	32'LİK PVC.ALEV YAYMAYAN BORU (BOY: 3M..)	30	mt.	2.331
001 045 120040 30 17	40'LİK PVC.ALEV YAYMAYAN BORU (BOY: 3M..)	30	mt.	3.050

Ürün Kodu	Açıklama / Stok Cinsi	Ambalaj (Kutulu)	Ambalaj Birimi	TL
DİRSEK VE MUFLAR ALEV YAYMAYAN				
001 051 010014 00 17	14'LÜK ALEV YAYMAYAN DİRSEK	700	ad.	0.377
001 051 010016 00 17	16'LİK ALEV YAYMAYAN DİRSEK	600	ad.	0.399
001 051 010018 00 17	18'LİK ALEV YAYMAYAN DİRSEK	400	ad.	0.529
001 051 010020 00 17	20'LİK ALEV YAYMAYAN DİRSEK	300	ad.	0.554
001 051 010025 00 17	25'LİK ALEV YAYMAYAN DİRSEK	150	ad.	0.746
001 051 010032 00 17	32'LİK ALEV YAYMAYAN DİRSEK	100	ad.	1.135
001 051 030014 00 17	14'LÜK ALEV YAYMAYAN MUF	700	ad.	0.329
001 051 030016 00 17	16'LİK ALEV YAYMAYAN MUF	700	ad.	0.329
001 051 030018 00 17	18'LİK ALEV YAYMAYAN MUF	500	ad.	0.464
001 051 030020 00 17	20'LİK ALEV YAYMAYAN MUF	500	ad.	0.464
001 051 030025 00 17	25'LİK ALEV YAYMAYAN MUF	300	ad.	0.858
001 051 030032 00 17	32'LİK ALEV YAYMAYAN MUF	200	ad.	0.939

PAH ÇİTASI				
001 012 000250 30 00	PAH ÇİTASI	100	mt.	0.850
001 012 100250 20 00	KULAKLI PAH ÇİTASI	100	mt.	0.876

MANDAL TİPİ DÖŞEME PASPAYI					
		Yükseklik	Kullanılır demir Çapı		
100 157 000101	15'LİK MANDAL	15 mm	6-14	2500	ad. 0.048
100 157 000102	20'LİK MANDAL	20 mm	6-14	2500	ad. 0.053
100 157 000103	25'LİK MANDAL	25 mm	6-14	2000	ad. 0.0554
100 157 000104	30'LİK MANDAL	30 mm	6-14	2000	ad. 0.063
100 157 000105	35'LİK MANDAL	35 mm	6-14	2000	ad. 0.090
100 157 000106	40'LİK MANDAL	40 mm	6-14	1500	ad. 0.103
100 157 000107	50'LİK MANDAL	50 mm	6-14	1500	ad. 0.111

NORM TİPİ DÖŞEME PASPAYI ELEMANLARI					
		Yükseklik	Kullanılır demir Çapı		
100 157 000200	20'LİK NORM	20 mm	8-24	1000	ad. 0.106
100 157 000201	25'LİK NORM	25 mm	8-24	900	ad. 0.116
100 157 000202	30'LİK NORM	30 mm	8-24	800	ad. 0.127
100 157 000203	35'LİK NORM	35 mm	8-24	800	ad. 0.143
100 157 000204	40'LİK NORM	40 mm	8-24	700	ad. 0.161
100 157 000205	45'LİK NORM	45 mm	8-24	700	ad. 0.174
100 157 000206	50'LİK NORM	50 mm	8-24	600	ad. 0.182

PERDE KOLON TİPİ PASPAYI ELEMANLARI					
		Yükseklik	Kullanılır demir Çapı		
100 157 000301	15'LİK P.PASPAYI	15 mm	5-10	3500	ad. 0.042
100 157 000302	20'LİK P.PASPAYI	20 mm	5-12	2500	ad. 0.048
100 157 000303	25'LİK P.PASPAYI	25 mm	5-16	2000	ad. 0.053
100 157 000304	30'LİK P.PASPAYI	30 mm	8-18	1000	ad. 0.092
100 157 000305	40'LİK P.PASPAYI	40 mm	8-18	700	ad. 0.132
100 157 000306	50'LİK P.PASPAYI	50 mm	8-32	400	ad. 0.266
100 157 000307	75'LİK P.PASPAYI	75 mm	8-32	200	ad. 0.523

SEHPALİ TİP DÖŞEME PASPAYI					
		Yükseklik	Kullanılır demir Çapı		
100 157 000401	15'LİK SEHPALİ	15 mm	6-14	2500	ad. 0.053
100 157 000402	20'LİK SEHPALİ	20 mm	6-14	2000	ad. 0.055
100 157 000403	25'LİK SEHPALİ	25 mm	6-14	2000	ad. 0.074
100 157 000404	30'LİK SEHPALİ	30 mm	6-14	1000	ad. 0.084
100 157 000405	35'LİK SEHPALİ	35 mm	6-14	1000	ad. 0.111
100 157 000406	40'LİK SEHPALİ	40 mm	6-14	1000	ad. 0.121
100 157 000407	50'LİK SEHPALİ	50 mm	6-14	1000	ad. 0.132

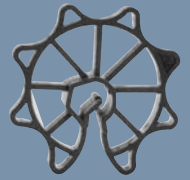



Ürün Kodu	Açıklama / Stok Cinsi	Ambalaj (Kutulu)	Ambalaj Birimi	TL
HALOGEN FREE TURUNCU BORULAR (EKONOMİK SERİ) (ALEV YAYAN)				
001 165 504014 00 12	14Q BORU (H.FREE TURUNCU) EKO. (ALEV YAYAN)	100	mt.	0.414
001 165 504016 00 12	16Q BORU (H.FREE TURUNCU) EKO. (ALEV YAYAN)	300	mt.	0.511
001 165 504018 00 12	18Q BORU (H.FREE TURUNCU) EKO. (ALEV YAYAN)	100	mt.	0.644
001 165 504020 00 12	20Q BORU (H.FREE TURUNCU) EKO. (ALEV YAYAN)	100	mt.	0.686
001 165 504025 00 12	25Q BORU (H.FREE TURUNCU) EKO. (ALEV YAYAN)	100	mt.	0.988
001 165 504032 00 12	32Q BORU (H.FREE TURUNCU) EKO. (ALEV YAYAN)	100	mt.	1.400
001 165 504037 00 12	37Q BORU (H.FREE TURUNCU) EKO. (ALEV YAYAN)	100	mt.	1.755
001 165 504040 00 12	40Q BORU (H.FREE TURUNCU) EKO. (ALEV YAYAN)	100	mt.	1.982
001 165 504050 00 12	50Q BORU (H.FREE TURUNCU) EKO. (ALEV YAYAN)	100	mt.	2.779
001 165 504063 00 12	63Q BORU (H.FREE TURUNCU) EKO. (ALEV YAYAN)	100	mt.	3.755
001 165 504075 00 12	75Q BORU (H.FREE TURUNCU) EKO. (ALEV YAYAN)	100	mt.	4.622
001 165 504090 00 12	90Q BORU (H.FREE TURUNCU) EKO. (ALEV YAYAN)	75	mt.	7.898
HALOGEN FREE TURUNCU BORULAR (6 ATÜ) (ALEV YAYAN)				
001 165 506014 00 12	14/6 ATÜ BORU (H.FREE TURUNCU) (ALEV YAYAN)	—	100 mt.	0.496
001 165 506016 00 12	16/6 ATÜ BORU (H.FREE TURUNCU) (ALEV YAYAN)	150	CE	300 mt. 0.594
001 165 506018 00 12	18/6 ATÜ BORU (H.FREE TURUNCU) (ALEV YAYAN)	—	100 mt.	0.713
001 165 506020 00 12	20/6 ATÜ BORU (H.FREE TURUNCU) (ALEV YAYAN)	150	CE	100 mt. 0.829
001 165 506025 00 12	25/6 ATÜ BORU (H.FREE TURUNCU) (ALEV YAYAN)	150	CE	100 mt. 1.079
001 165 506032 00 12	32/6 ATÜ BORU (H.FREE TURUNCU) (ALEV YAYAN)	150	CE	100 mt. 1.687
001 165 506037 00 12	37/6 ATÜ BORU (H.FREE TURUNCU) (ALEV YAYAN)	—	100 mt.	2.281
001 165 506040 00 12	40/6 ATÜ BORU (H.FREE TURUNCU) (ALEV YAYAN)	150	CE	100 mt. 2.353
001 165 506050 00 12	50/6 ATÜ BORU (H.FREE TURUNCU) (ALEV YAYAN)	150	CE	100 mt. 3.414
001 165 506063 00 12	63/6 ATÜ BORU (H.FREE TURUNCU) (ALEV YAYAN)	150	CE	100 mt. 4.823
001 165 506075 00 12	75/6 ATÜ BORU (H.FREE TURUNCU) (ALEV YAYAN)	150	CE	100 mt. 5.964
001 165 506090 00 12	90/6 ATÜ BORU (H.FREE TURUNCU) (ALEV YAYAN)	—	75 mt.	9.585
HALOGEN FREE TURUNCU BORULAR (10 ATÜ) (ALEV YAYAN)				
001 165 510014 00 12	14/10 ATÜ BORU (H.FREE TURUNCU) (ALEV YAYAN)	—	100 mt.	0.556
001 165 510016 00 12	16/10 ATÜ BORU (H.FREE TURUNCU) (ALEV YAYAN)	150	CE	300 mt. 0.660
001 165 510018 00 12	18/10 ATÜ BORU (H.FREE TURUNCU) (ALEV YAYAN)	—	100 mt.	0.828
001 165 510020 00 12	20/10 ATÜ BORU (H.FREE TURUNCU) (ALEV YAYAN)	150	CE	100 mt. 0.982
001 165 510025 00 12	25/10 ATÜ BORU (H.FREE TURUNCU) (ALEV YAYAN)	150	CE	100 mt. 1.245
001 165 510032 00 12	32/10 ATÜ BORU (H.FREE TURUNCU) (ALEV YAYAN)	150	CE	100 mt. 2.027
001 165 510037 00 12	37/10 ATÜ BORU (H.FREE TURUNCU) (ALEV YAYAN)	—	100 mt.	2.336
001 165 510040 00 12	40/10 ATÜ BORU (H.FREE TURUNCU) (ALEV YAYAN)	150	CE	100 mt. 3.382
001 165 510050 00 12	50/10 ATÜ BORU (H.FREE TURUNCU) (ALEV YAYAN)	150	CE	100 mt. 3.945
001 165 510063 00 12	63/10 ATÜ BORU (H.FREE TURUNCU) (ALEV YAYAN)	150	CE	100 mt. 5.758
001 165 510075 00 12	75/10 ATÜ BORU (H.FREE TURUNCU) (ALEV YAYAN)	150	CE	100 mt. 6.944
001 165 510090 00 12	90/10 ATÜ BORU (H.FREE TURUNCU) (ALEV YAYAN)	150	CE	75 mt. 13.328
001 165 510100 00 12	100/10 ATÜ BORU (H.FREE TURUNCU) (ALEV YAYAN)	—	50 mt.	13.594
001 165 510110 00 12	110/10 ATÜ BORU (H.FREE TURUNCU) (ALEV YAYAN)	150	CE	50 mt. 16.902
HALOGEN FREE MAVİ BORULAR (6 ATÜ) (ALEV YAYMAYAN)				
001 165 106014 00 12	14/6 ATÜ BORU (H.FREE MAVİ) (ALEV YAYMAYAN)	—	100 mt.	0.929
001 165 106016 00 12	16/6 ATÜ BORU (H.FREE MAVİ) (ALEV YAYMAYAN)	150	CE	100 mt. 1.115
001 165 106018 00 12	18/6 ATÜ BORU (H.FREE MAVİ) (ALEV YAYMAYAN)	—	100 mt.	1.283
001 165 106020 00 12	20/6 ATÜ BORU (H.FREE MAVİ) (ALEV YAYMAYAN)	150	CE	100 mt. 1.468
001 165 106025 00 12	25/6 ATÜ BORU (H.FREE MAVİ) (ALEV YAYMAYAN)	150	CE	100 mt. 2.130
001 165 106032 00 12	32/6 ATÜ BORU (H.FREE MAVİ) (ALEV YAYMAYAN)	150	CE	100 mt. 3.163
001 165 106037 00 12	37/6 ATÜ BORU (H.FREE MAVİ) (ALEV YAYMAYAN)	—	100 mt.	3.802
001 165 106040 00 12	40/6 ATÜ BORU (H.FREE MAVİ) (ALEV YAYMAYAN)	150	CE	100 mt. 4.685
001 165 106050 00 12	50/6 ATÜ BORU (H.FREE MAVİ) (ALEV YAYMAYAN)	150	CE	100 mt. 6.510
001 165 106063 00 12	63/6 ATÜ BORU (H.FREE MAVİ) (ALEV YAYMAYAN)	150	CE	100 mt. 8.968
001 165 106075 00 12	75/6 ATÜ BORU (H.FREE MAVİ) (ALEV YAYMAYAN)	150	CE	100 mt. 10.243
001 165 106090 00 12	90/6 ATÜ BORU (H.FREE MAVİ) (ALEV YAYMAYAN)	—	75 mt.	15.000
HALOGEN FREE MAVİ BORULAR (10 ATÜ) (ALEV YAYMAYAN)				
001 165 110014 00 12	14/10 ATÜ BORU (H.FREE MAVİ) (ALEV YAYMAYAN)	—	100 mt.	1.052
001 165 110016 00 12	16/10 ATÜ BORU (H.FREE MAVİ) (ALEV YAYMAYAN)	150	CE	100 mt. 1.258
001 165 110018 00 12	18/10 ATÜ BORU (H.FREE MAVİ) (ALEV YAYMAYAN)	—	100 mt.	1.455
001 165 110020 00 12	20/10 ATÜ BORU (H.FREE MAVİ) (ALEV YAYMAYAN)	150	CE	100 mt. 2.011
001 165 110025 00 12	25/10 ATÜ BORU (H.FREE MAVİ) (ALEV YAYMAYAN)	150	CE	100 mt. 2.394
001 165 110032 00 12	32/10 ATÜ BORU (H.FREE MAVİ) (ALEV YAYMAYAN)	150	CE	100 mt. 3.800
001 165 110037 00 12	37/10 ATÜ BORU (H.FREE MAVİ) (ALEV YAYMAYAN)	—	100 mt.	4.611
001 165 110040 00 12	40/10 ATÜ BORU (H.FREE MAVİ) (ALEV YAYMAYAN)	150	CE	100 mt. 5.475
001 165 110050 00 12	50/10 ATÜ BORU (H.FREE MAVİ) (ALEV YAYMAYAN)	150	CE	100 mt. 7.459
001 165 110063 00 12	63/10 ATÜ BORU (H.FREE MAVİ) (ALEV YAYMAYAN)	150	CE	100 mt. 10.449
001 165 110075 00 12	75/10 ATÜ BORU (H.FREE MAVİ) (ALEV YAYMAYAN)	150	CE	100 mt. 13.241
001 165 110090 00 12	90/10 ATÜ BORU (H.FREE MAVİ) (ALEV YAYMAYAN)	150	CE	75 mt. 20.637
001 165 110100 00 12	100/10 ATÜ BORU (H.FREE MAVİ) (ALEV YAYMAYAN)	—	50 mt.	27.312
001 165 110110 00 12	110/10 ATÜ BORU (H.FREE MAVİ) (ALEV YAYMAYAN)	150	CE	50 mt. 29.000

Ürün Kodu	Açıklama / Stok Cinsi	Ambalaj (Kutulu)	Ambalaj Birimi	TL
POLİETİLEN SİYAH BORULAR (EKONOMİK SERİ)				
001 165 404014 00 11	14 Q POLİETİLEN BORU EKO. (SİYAH)	100	mt.	0.366
001 165 404016 00 11	16 Q POLİETİLEN BORU EKO. (SİYAH)	100	mt.	0.456
001 165 404018 00 11	18 Q POLİETİLEN BORU EKO. (SİYAH)	100	mt.	0.527
001 165 404020 00 11	20 Q POLİETİLEN BORU EKO. (SİYAH)	100	mt.	0.667
001 165 404025 00 11	25 Q POLİETİLEN BORU EKO. (SİYAH)	100	mt.	0.842
001 165 404032 00 11	32 Q POLİETİLEN BORU EKO. (SİYAH)	100	mt.	1.269
001 165 404037 00 11	37 Q POLİETİLEN BORU EKO. (SİYAH)	100	mt.	1.492
001 165 404040 00 11	40 Q POLİETİLEN BORU EKO. (SİYAH)	100	mt.	1.697
001 165 404050 00 11	50 Q POLİETİLEN BORU EKO. (SİYAH)	100	mt.	2.124
001 165 404063 00 11	63 Q POLİETİLEN BORU EKO. (SİYAH)	100	mt.	3.159
001 165 404075 00 11	75 Q POLİETİLEN BORU EKO. (SİYAH)	100	mt.	4.264
001 165 404090 00 11	90 Q POLİETİLEN BORU EKO. (SİYAH)	75	mt.	6.266
POLİETİLEN SİYAH BORULAR (6 ATÜ)				
001 165 406014 00 11	14/6 ATÜ POLİETİLEN BORU (SİYAH)	—	100	mt. 0.462
001 165 406016 00 11	16/6 ATÜ POLİETİLEN BORU (SİYAH)	CE	100	mt. 0.554
001 165 406018 00 11	18/6 ATÜ POLİETİLEN BORU (SİYAH)	—	100	mt. 0.630
001 165 406020 00 11	20/6 ATÜ POLİETİLEN BORU (SİYAH)	CE	100	mt. 0.776
001 165 406025 00 11	25/6 ATÜ POLİETİLEN BORU (SİYAH)	CE	100	mt. 1.011
001 165 406032 00 11	32/6 ATÜ POLİETİLEN BORU (SİYAH)	CE	100	mt. 1.652
001 165 406037 00 11	37/6 ATÜ POLİETİLEN BORU (SİYAH)	—	100	mt. 2.163
001 165 406040 00 11	40/6 ATÜ POLİETİLEN BORU (SİYAH)	CE	100	mt. 2.089
001 165 406050 00 11	50/6 ATÜ POLİETİLEN BORU (SİYAH)	CE	100	mt. 2.825
001 165 406063 00 11	63/6 ATÜ POLİETİLEN BORU (SİYAH)	CE	100	mt. 4.509
001 165 406075 00 11	75/6 ATÜ POLİETİLEN BORU (SİYAH)	CE	100	mt. 5.822
001 165 406090 00 11	90/6 ATÜ POLİETİLEN BORU (SİYAH)	—	75	mt. 7.955
POLİETİLEN SİYAH BORULAR (10 ATÜ)				
001 165 410014 00 11	14/10 ATÜ POLİETİLEN BORU (SİYAH)	—	100	mt. 0.529
001 165 410016 00 11	16/10 ATÜ POLİETİLEN BORU (SİYAH)	CE	100	mt. 0.623
001 165 410018 00 11	18/10 ATÜ POLİETİLEN BORU (SİYAH)	—	100	mt. 0.780
001 165 410020 00 11	20/10 ATÜ POLİETİLEN BORU (SİYAH)	CE	100	mt. 0.928
001 165 410025 00 11	25/10 ATÜ POLİETİLEN BORU (SİYAH)	CE	100	mt. 1.171
001 165 410032 00 11	32/10 ATÜ POLİETİLEN BORU (SİYAH)	CE	100	mt. 1.818
001 165 410037 00 11	37/10 ATÜ POLİETİLEN BORU (SİYAH)	—	100	mt. 2.193
001 165 410040 00 11	40/10 ATÜ POLİETİLEN BORU (SİYAH)	CE	100	mt. 2.964
001 165 410050 00 11	50/10 ATÜ POLİETİLEN BORU (SİYAH)	CE	100	mt. 3.669
001 165 410063 00 11	63/10 ATÜ POLİETİLEN BORU (SİYAH)	CE	100	mt. 5.336
001 165 410075 00 11	75/10 ATÜ POLİETİLEN BORU (SİYAH)	CE	100	mt. 6.141
001 165 410090 00 11	90/10 ATÜ POLİETİLEN BORU (SİYAH)	CE	75	mt. 9.608
001 165 410100 00 11	100/10 ATÜ POLİETİLEN BORU (SİYAH)	—	50	mt. 12.717
001 165 410110 00 11	110/10 ATÜ POLİETİLEN BORU (SİYAH)	CE	50	mt. 13.500
PLASTİK BORULAR				
001 045 000014 30 00	14 MM KALIN BOY BORU	102	mt.	0.344
001 045 000018 30 00	18 MM KALIN BOY BORU	102	mt.	0.466
001 045 000026 30 00	26 MM KALIN BOY BORU	51	mt.	0.808
001 045 000037 30 00	37 MM KALIN BOY BORU	30	mt.	1.585
001 045 010014 00 11	14 MM KANGAL (NORMAL)	100	mt.	0.350
001 045 010018 00 11	18 MM KANGAL (NORMAL)	100	mt.	0.465
001 045 010026 00 11	26 MM KANGAL (NORMAL)	50	mt.	0.827
001 045 010037 00 11	37 MM KANGAL (NORMAL)	50	mt.	1.463
001 045 020014 00 00	14 MM KANGAL (KAUÇUK)	100	mt.	0.360
001 045 020018 00 00	18 MM KANGAL (KAUÇUK)	100	mt.	0.475
001 045 020026 00 00	26 MM KANGAL (KAUÇUK)	50	mt.	0.911
001 045 020037 00 00	37 MM KANGAL (KAUÇUK)	50	mt.	1.774
001 045 030014 00 00	14 MM KANGAL (KAUÇUK) (KALIN)	100	mt.	0.417
001 045 030018 00 00	18 MM KANGAL (KAUÇUK) (KALIN)	100	mt.	0.586
HDPE KORUGE BORULAR				
096 045 150050	Q50 KORUGE KANGAL BORU	100	mt.	2.040
096 045 150060	Q63 KORUGE KANGAL BORU	100	mt.	2.280
096 045 150075	Q75 KORUGE KANGAL BORU	100	mt.	2.880
096 045 150100	Q100 KORUGE BOY BORU (6 MT.)	6	mt.	3.360
096 045 150115	Q115 KORUGE BOY BORU (6 MT.)	6	mt.	3.480
096 045 150002	Q100 MANŞON	1	ad.	1.920
096 045 150001	Q115 MANŞON	1	ad.	2.040
LÜX BUAT KAPAKLARI				
126 046 180001	LÜX BUAT KAPAĞI (BOMBELİ-PLASTİK AYAK)	100	ad.	0.180
126 046 180002	LÜX BUAT KAPAĞI (BOMBELİ-SAC AYAK)	100	ad.	0.360
126 046 180003	LÜX BUAT KAPAĞI (DÜZ-PLASTİK AYAK)	100	ad.	0.180
126 046 180004	LÜX BUAT KAPAĞI (BOMB.PLASTİK AYAK)VIDALI	100	ad.	0.264

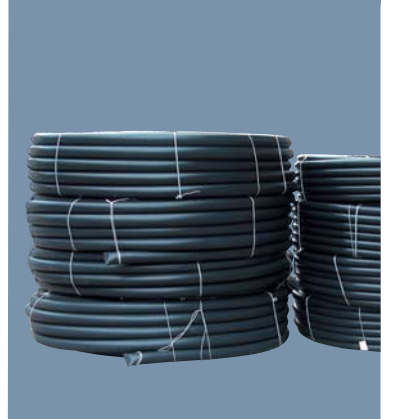

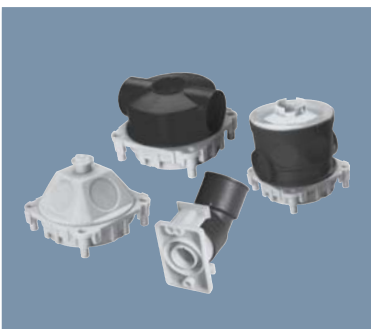
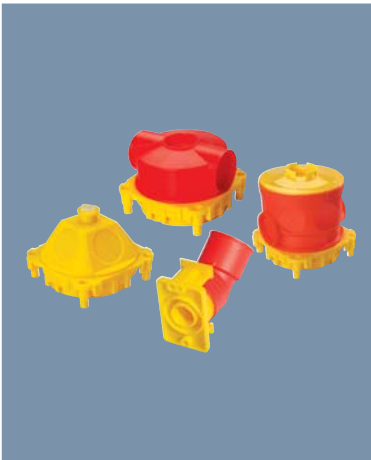
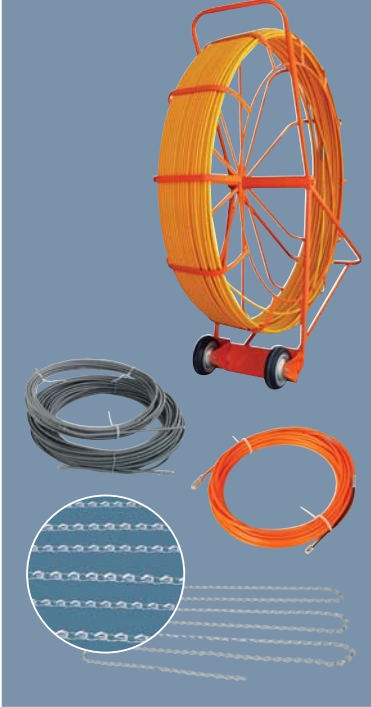

Ürün Kodu	Açıklama / Stok Cinsi	Ambalaj (Kutulu)	Ambalaj Birimi	TL
PLASTİK DİRSEK VE MUFLAR				
127 051 000014	PLASTİK 14 Q DİRSEK	2000	ad.	0.083
127 051 000018	PLASTİK 18 Q DİRSEK	1000	ad.	0.105
127 051 000026	PLASTİK 26 Q DİRSEK	500	ad.	0.150
001 051 020014 00 11	PLASTİK 14 Q MUF	1500	ad.	0.099
001 051 020018 00 11	PLASTİK 18 Q MUF	1000	ad.	0.178
001 051 020026 00 11	PLASTİK 26 Q MUF	500	ad.	0.207
001 051 020037 00 11	PLASTİK 37 Q MUF	250	ad.	0.456
FİBER SUSTALAR				
999 999 000779	FİBER KLAVUZ	1	mt	11.250
999 999 000780	FİBER KLAVUZ MAKARASI	1	ad.	625.000
PVC.İZOLE KAPLI ÇELİK SUSTA				
049 019 300010	10 MT. PVC.İZOLE KAPLI ÇELİK SUSTA	1	ad.	22.500
049 019 300015	15 MT. PVC.İZOLE KAPLI ÇELİK SUSTA	1	ad.	30.000
049 019 300020	20 MT. PVC.İZOLE KAPLI ÇELİK SUSTA	1	ad.	37.500
049 019 300025	25 MT. PVC.İZOLE KAPLI ÇELİK SUSTA	1	ad.	45.000
PLASTİK SUSTALAR (KILAVUZ TELLİ)				
049 019 400025	10 MT.KILAVUZ TELLİ PLASTİK SUSTA	1	ad.	9.375
049 019 400025	15 MT.KILAVUZ TELLİ PLASTİK SUSTA	1	ad.	14.375
049 019 400025	20 MT.KILAVUZ TELLİ PLASTİK SUSTA	1	ad.	18.750
049 019 400025	25 MT KILAVUZ TELLİ PLASTİK SUSTA	1	ad.	23.750
ÇELİK SUSTA VE ZİNCİR				
001 019 000010 00 00	SUSTA (1.KALİTE) (10M)	40	ad.	7.864
001 019 000015 00 00	SUSTA (1.KALİTE) (15M)	30	ad.	11.768
001 019 000020 00 00	SUSTA (1.KALİTE) (20M)	20	ad.	15.351
001 019 000025 00 00	SUSTA (1.KALİTE) (25M)	15	ad.	19.096
001 019 100010 00 00	TAKVİYELİ SUSTA(1.KALİTE)(10M)	40	ad.	9.045
001 019 100015 00 00	TAKVİYELİ SUSTA(1.KALİTE)(15M)	30	ad.	13.382
001 019 100020 00 00	TAKVİYELİ SUSTA(1.KALİTE)(20M)	20	ad.	17.716
001 019 100025 00 00	TAKVİYELİ SUSTA(1.KALİTE)(25M)	15	ad.	22.053
001 018 000001 00 00	FLORESAN ZİNCİRİ	500	mt.	0.464
BETON DUVAR ANAHTAR KASALARI (H.FREE ALEV YAYMAYAN)				
000 700 200037 00 14	BUAT ARKA KAPAK SARI (ALEV YAYMAYAN)	500	ad.	0.454
000 700 200035 00 12	BUAT GÖVDE 60'LİK TURUNCU (ALEV YAYMAYAN)	350	ad.	0.614
000 700 200256 00 14	KALIBA TESPİT ELEMANI SARI (ALEV YAYMAYAN)	500	ad.	0.543
000 700 200039 00 12	SIĞ BRÜT ANAHTAR KASASI TURUNCU (ALEV YAYMAYAN)	500	ad.	0.663
000 700 200036 00 14	KONİK GÖVDE SARI (ALEV YAYMAYAN)	250	ad.	0.566
000 700 200214 00 14	APLİK 20'LİK SARI (ALEV YAYMAYAN)	100	ad.	0.395
000 700 200215 00 12	APLİK EĞİK BAĞLANTI DİRSEĞİ TURUNCU (ALEV YAYMAYAN)	100	ad.	0.326
BETON DUVAR ANAHTAR KASALARI (H.FREE ALEV YAYAN)				
000 700 000037 00 14	BUAT ARKA KAPAK SARI (ALEV YAYAN)	500	ad.	0.324
000 700 000035 00 12	BUAT GÖVDE 60'LİK TURUNCU (ALEV YAYAN)	350	ad.	0.438
000 700 000256 00 14	KALIBA TESPİT ELEMANI SARI (ALEV YAYAN)	500	ad.	0.388
000 700 000039 00 12	SIĞ BRÜT ANAHTAR KASASI TURUNCU (ALEV YAYAN)	500	ad.	0.473
000 700 000036 00 14	KONİK GÖVDE SARI (ALEV YAYAN)	250	ad.	0.404
000 700 000214 00 14	APLİK 20'LİK SARI (ALEV YAYAN)	100	ad.	0.282
000 700 000215 00 12	APLİK EĞİK BAĞLANTI DİRSEĞİ TURUNCU (ALEV YAYAN)	100	ad.	0.233
BETON DUVAR ANAHTAR KASALARI (SİYAH)				
000 700 000037 00 11	BUAT ARKA KAPAK SİYAH	500	ad.	0.155
000 700 000035 00 11	BUAT GÖVDE 60'LİK SİYAH	350	ad.	0.263
000 700 000256 00 11	KALIBA TESPİT ELEMANI SİYAH	500	ad.	0.388
000 700 000039 00 11	SIĞ BRÜT ANAHTAR KASASI SİYAH	500	ad.	0.449
000 700 000036 00 11	KONİK GÖVDE SİYAH	250	ad.	0.380
000 700 000214 00 11	APLİK 20'LİK SİYAH	100	ad.	0.281
000 700 000215 00 11	APLİK EĞİK BAĞLANTI DİRSEĞİ SİYAH	100	ad.	0.232

Ürün Kodu	Açıklama / Stok Cinsi	Ambalaj (Kutulu)	Ambalaj Birimi	TL
GEÇMELİ BUAT KLEMESLERİ				
888 094 260802	BM802 GEÇMELİ BUAT KLEMENSİ (2'Lİ)	100	ad.	0.102 USD.
888 094 260803	BM803 GEÇMELİ BUAT KLEMENSİ (3'LÜ)	100	ad.	0.154 USD.
888 094 260804	BM804 GEÇMELİ BUAT KLEMENSİ (4'LÜ)	100	ad.	0.192 USD.
888 094 260805	BM805 GEÇMELİ BUAT KLEMENSİ (5'Lİ)	100	ad.	0.230 USD.
015 094 160001	NO. 2 ZEYTİN (BUAT) KLEMENS	1000	ad.	0.065



TURUNCU KASA VE BUATLAR (ALEV YAYMAYAN)				TSE	CE
126 046 210001	NORM KASA (TURUNCU) (ALEV YAYMAYAN)	100	ad.	0.265	
126 046 131101	NORM BUAT (TURUNCU) (ALEV YAYMAYAN)	50	ad.	0.419	
001 046 160102 00 12	GEÇMELİ PLASTİK KASA (TURUNCU) (ALEV YAYMAYAN)	400	ad.	0.748	
126 046 180201	GEÇMELİ DERİN KASA (TURUNCU) (ALEV YAYMAYAN)	300	ad.	0.839	
001 046 170101 00 12	TÜNEL KASA (TURUNCU) (ALEV YAYMAYAN)	500	ad.	1.155	
001 046 170102 00 12	TÜNEL BUAT (TURUNCU) (ALEV YAYMAYAN)	300	ad.	0.956	
001 046 121101 00 12	ALÇIPAN KASA 1'Lİ (TURUNCU) (ALEV YAYMAYAN)	300	ad.	1.759	
001 046 121102 00 12	ALÇIPAN KASA 2'Lİ (TURUNCU) (ALEV YAYMAYAN)	200	ad.	2.591	
001 046 121103 00 12	ALÇIPAN KASA 3'LÜ (TURUNCU) (ALEV YAYMAYAN)	100	ad.	3.455	



TURUNCU KASA VE BUATLAR (ALEV YAYAN)				TSE	CE
126 046 130102	NORM KASA (TURUNCU) (ALEV YAYAN)	100	ad.	0.204	
126 046 130101	NORM BUAT (TURUNCU) (ALEV YAYAN)	50	ad.	0.350	
001 046 160102 00 12	GEÇMELİ PLASTİK KASA (TURUNCU) (ALEV YAYAN)	400	ad.	0.665	
126 046 160101	GEÇMELİ DERİN KASA (TURUNCU) (ALEV YAYAN)	300	ad.	0.646	
001 046 170101 00 12	TÜNEL KASA (TURUNCU) (ALEV YAYAN)	500	ad.	0.888	
001 046 170102 00 12	TÜNEL BUAT (TURUNCU) (ALEV YAYAN)	300	ad.	0.735	
001 046 120101 00 12	ALÇIPAN KASA 1'Lİ (TURUNCU) (ALEV YAYAN)	300	ad.	1.354	
001 046 120102 00 12	ALÇIPAN KASA 2'Lİ (TURUNCU) (ALEV YAYAN)	200	ad.	1.994	
001 046 120103 00 12	ALÇIPAN KASA 3'LÜ (TURUNCU) (ALEV YAYAN)	100	ad.	2.658	

PLASTİK KASA-BUAT-TAKOZLAR				TSE	CE
047 109 010013	ANAHTAR ALTI (DESENLİ)	100	ad.	0.702	
126 046 130103	NORM KASA	100	ad.	0.143	
126 046 130104	NORM BUAT (14-18 ÇIKIŞLI)	50	ad.	0.260	
126 046 130105	NORM BUAT KAPAKSIZ	50	ad.	0.234	
001 046 160102 00 11	GEÇMELİ PLASTİK KASA	400	ad.	0.348	
126 046 130106	GEÇMELİ DERİN KASA	300	ad.	0.268	
126 046 130107	GEÇMELİ DERİN KASA KAPAKSIZ	300	ad.	0.234	
001 046 120101 00 11	ALÇIPAN KASA 1'Lİ	300	ad.	1.022	
001 046 120102 00 11	ALÇIPAN KASA 2'Lİ	200	ad.	1.386	
001 046 120103 00 11	ALÇIPAN KASA 3'Lİ	100	ad.	1.879	
001 046 170101 00 11	TÜNEL KASA	500	ad.	0.647	
001 046 170102 00 11	TÜNEL BUAT	300	ad.	0.508	
001 046 000001 00 11	PLASTİK TAKOZ (14-18 ÇIKIŞLI)	100	ad.	0.187	
999 999 000215	TAHTA TAKOZ	750	ad.	0.146	



TURUNCU KARE BUAT VE ANTİGRON BUATLAR				TSE	CE
001 046 000101 00 12	85X85 KARE ANTİGRON BUAT TURUNCU	—	10	ad.	2.472
001 046 021010 00 12	10X10 KARE BUAT TURUNCU	TSE	10	ad.	1.597
001 046 021212 00 12	12X12 KARE BUAT TURUNCU	TSE	10	ad.	2.369
001 046 021515 00 12	15X15 KARE BUAT TURUNCU	TSE	10	ad.	3.296
001 046 022020 00 12	20X20 KARE BUAT TURUNCU	TSE	10	ad.	4.120
001 046 000103 00 12	ANTİGRON BUAT 3'LÜ TURUNCU	TSE	10	ad.	1.545
001 046 000104 00 12	ANTİGRON BUAT 4'LÜ TURUNCU	TSE	10	ad.	1.648



KARE BUAT-ANTİGRON BUAT VE ROZANSLAR				TSE	CE
001 046 000101 00 00	KARE ANTİGRON BUAT 85X85	—	10	ad.	1.303
001 046 021010 00 11	10X10 KARE BUAT	—	10	ad.	1.288
001 046 021212 00 11	12X12 KARE BUAT	—	10	ad.	1.573
001 046 021515 00 11	15X15 KARE BUAT	—	10	ad.	2.450
001 046 022020 00 11	20X20 KARE BUAT	—	10	ad.	3.300
001 046 000103 00 11	ANTİGRON BUAT 3'LÜ PLASTİK (SİYAH)	—	10	ad.	0.888
001 046 000104 00 11	ANTİGRON BUAT 4'LÜ PLASTİK (SİYAH)	—	10	ad.	0.936
001 046 000103 00 00	ANTİGRON BUAT 3'LÜ PLASTİK (BEYAZ)	—	10	ad.	0.948
001 046 000104 00 00	ANTİGRON BUAT 4'LÜ PLASTİK (BEYAZ)	—	10	ad.	1.007



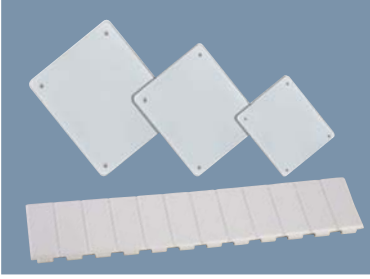

Ürün Kodu	Açıklama / Stok Cinsi	Ambalaj (Kutulu)	Ambalaj Birimi	TL
KARE BUAT KAPAKLARI				
000 700 000043 00 00	10X10 KARE BUAT KAPAĞI	1	ad.	0.426
000 700 000045 00 00	12X12 KARE BUAT KAPAĞI	1	ad.	0.526
000 700 000047 00 00	15X15 KARE BUAT KAPAĞI	1	ad.	0.682
000 700 000049 00 00	20X20 KARE BUAT KAPAĞI	1	ad.	1.336

ÖRTME PARÇALARI				
001 026 000002 00 00	W OTOMAT ÖRTME PARÇASI (12'Lİ) YENİ TİP	50	ad.	1.442

MULTIMEDIA ZAYIF AKIM KUTUSU (MODÜLLÜ)				
888 111 000001	ZAYIF AKIM KUTUSU KOMPLE MODÜLLÜ (SAÇ)	1	ad.	90.000

PLASTİK ZAYIF AKIM KUTUSU (TABAN SAÇLI)				
097 130 012230	SIVA ALTI PLS.ZAYIF AKIM KUTUSU (TABAN SAÇLI) 22X30 CM.	1	ad.	26.250
097 130 022230	SIVA ÜSTÜ PLS.ZAYIF AKIM KUTUSU (TABAN SAÇLI) 22X30 CM.	1	ad.	30.000
097 130 013530	SIVA ALTI PLS.ZAYIF AKIM KUTUSU (TABAN SAÇLI) 35X30 CM.	1	ad.	38.750
097 130 023530	SIVA ÜSTÜ PLS.ZAYIF AKIM KUTUSU (TABAN SAÇLI) 35X30 CM.	1	ad.	42.500

SAAT KUTULARI				
017 027 000001	MONOFAZE SAAT KUTUSU (PLASTİK) ESKİ TİP	20	ad.	2.500
999 999 000261	MONOFAZE SAAT KUTUSU (SAC) ESKİ TİP	5	ad.	15.000
999 999 000262	TRİFAZE SAAT KUTUSU (SAC) ESKİ TİP	5	ad.	17.500

MEKSBOX W OTOMAT KUTULARI (YENİ MODEL)				
001 027 800002 00 00	MÜHÜRLÜ W OTOMAT KUT.(S/Ü) 2 Lİ (ESKİ TİP)	20	ad.	0.850
001 027 200001 00 00	MÜHÜRLÜ W OTOMAT KUT.(S/Ü) 1 Lİ	20	ad.	0.981
001 027 200002 00 00	MÜHÜRLÜ W OTOMAT KUT.(S/Ü) 2 Lİ	20	ad.	1.258
001 027 200004 00 00	MÜHÜRLÜ W OTOMAT KUT.(S/Ü) 4 LÜ	10	ad.	2.049
001 027 100002 00 00	W OTOMAT KUT.(S/Ü)MEKSBOX 2 Lİ	30	ad.	6.140
001 027 000002 00 00	W OTOMAT KUT.(S/A)MEKSBOX 2 Lİ	30	ad.	6.140
001 027 100004 00 00	W OTOMAT KUT.(S/Ü)MEKSBOX 4 LÜ	20	ad.	7.192
001 027 000004 00 00	W OTOMAT KUT.(S/A)MEKSBOX 4 LÜ	20	ad.	7.194
001 027 100006 00 00	W OTOMAT KUT.(S/Ü)MEKSBOX 6 Lİ	20	ad.	9.722
001 027 000006 00 00	W OTOMAT KUT.(S/A)MEKSBOX 6 Lİ	20	ad.	9.722
001 027 100009 00 00	W OTOMAT KUT.(S/Ü)MEKSBOX 9 LU	20	ad.	12.098
001 027 000009 00 00	W OTOMAT KUT.(S/A)MEKSBOX 9 LU	20	ad.	12.098
001 027 100012 00 00	W OTOMAT KUT.(S/Ü)MEKSBOX 12 Lİ	10	ad.	14.508
001 027 000012 00 00	W OTOMAT KUT.(S/A)MEKSBOX 12 Lİ	10	ad.	14.509
001 027 100016 00 00	W OTOMAT KUT.(S/Ü)MEKSBOX 16 Lİ	10	ad.	17.667
001 027 000016 00 00	W OTOMAT KUT.(S/A)MEKSBOX 16 Lİ	10	ad.	17.667
001 027 100024 00 00	W OTOMAT KUT.(S/Ü)MEKSBOX 24 LÜ	5	ad.	24.198
001 027 000024 00 00	W OTOMAT KUT.(S/A)MEKSBOX 24 LÜ	5	ad.	24.198
001 027 100036 00 00	W OTOMAT KUT.(S/Ü)MEKSBOX 36 Lİ	5	ad.	32.052
001 027 000036 00 00	W OTOMAT KUT.(S/A)MEKSBOX 36 Lİ	5	ad.	32.052

MEKSBOX W OTOMAT KUTULARI (YENİ MODEL) (ALEV YAYMAYAN)				
001 027 210001 00 00	MÜH.W OTOMAT KUT.ALEV YAYMAYAN(S/Ü)1 Lİ	20	ad.	1.459
001 027 210002 00 00	MÜH.W OTOMAT KUT.ALEV YAYMAYAN(S/Ü)2 Lİ	20	ad.	1.772
001 027 210004 00 00	MÜH.W OTOMAT KUT.ALEV YAYMAYAN(S/Ü)4 LÜ	10	ad.	2.426
001 027 110002 00 00	W OTOMAT KUT.(S/Ü)ALEV YAYMAYAN 2 Lİ	30	ad.	6.929
001 027 010002 00 00	W OTOMAT KUT.(S/A)ALEV YAYMAYAN 2 Lİ	30	ad.	6.932
001 027 110004 00 00	W OTOMAT KUT.(S/Ü)ALEV YAYMAYAN 4 LÜ	20	ad.	8.469
001 027 010004 00 00	W OTOMAT KUT.(S/A)ALEV YAYMAYAN 4 LÜ	20	ad.	8.576
001 027 110006 00 00	W OTOMAT KUT.(S/Ü)ALEV YAYMAYAN 6 Lİ	20	ad.	12.352
001 027 010006 00 00	W OTOMAT KUT.(S/A)ALEV YAYMAYAN 6 Lİ	20	ad.	12.204
001 027 110009 00 00	W OTOMAT KUT.(S/Ü)ALEV YAYMAYAN 9 LU	20	ad.	16.237
001 027 010009 00 00	W OTOMAT KUT.(S/A)ALEV YAYMAYAN 9 LU	20	ad.	16.237
001 027 110012 00 00	W OTOMAT KUT.(S/Ü)ALEV YAYMAYAN 12 Lİ	10	ad.	21.212
001 027 010012 00 00	W OTOMAT KUT.(S/A)ALEV YAYMAYAN 12 Lİ	10	ad.	21.212
001 027 110016 00 00	W OTOMAT KUT.(S/Ü)ALEV YAYMAYAN 16 Lİ	10	ad.	27.518
001 027 010016 00 00	W OTOMAT KUT.(S/A)ALEV YAYMAYAN 16 Lİ	10	ad.	27.518
001 027 110024 00 00	W OTOMAT KUT.(S/Ü)ALEV YAYMAYAN 24 LÜ	5	ad.	36.720
001 027 010024 00 00	W OTOMAT KUT.(S/A)ALEV YAYMAYAN 24 LÜ	5	ad.	36.720
001 027 110036 00 00	W OTOMAT KUT.(S/Ü)ALEV YAYMAYAN 36 Lİ	5	ad.	53.421
001 027 010036 00 00	W OTOMAT KUT.(S/A)ALEV YAYMAYAN 36 Lİ	5	ad.	53.421

Ürün Kodu	Açıklama / Stok Cinsi	Ambalaj (Kutulu)	Ambalaj Birimi	TL
TELEFON DAĞITIM KUTULARI ve AKSESUARLARI				
001 049 001020 00 00	TLF. DĞT. KUTUSU (10 - 20) BOŞ PLS. KLT	IP40	60 ad.	10.661
001 049 011020 00 00	TLF. DĞT. KUTUSU (10 - 20) BOŞ KİLİTLİ	IP40	60 ad.	16.584
001 049 001050 00 00	TLF. DĞT. KUTUSU(10-50) BOŞ PLS.KİLİT	IP40	28 ad.	16.584
001 049 011050 00 00	TLF. DĞT. KUTUSU(10-50) KİLİTLİ	IP40	28 ad.	23.700
061 049 015012	H.TDK. (50 - 120) KİLİTLİ TİP. PER. BOŞ.		12 ad.	45.000
001 024 000001 00 00	ÇATI (1 MODÜL İÇİN)		1 ad.	0.860
001 024 000002 00 00	ÇATI (2 MODÜL İÇİN)		1 ad.	1.720
001 024 000003 00 00	ÇATI (3 MODÜL İÇİN)		1 ad.	2.580
001 024 000004 00 00	ÇATI (4 MODÜL İÇİN)		1 ad.	3.440
001 024 000005 00 00	ÇATI (5 MODÜL İÇİN)		1 ad.	4.300
001 024 000006 00 00	ÇATI (6 MODÜL İÇİN)		1 ad.	5.160
001 024 000007 00 00	ÇATI (7 MODÜL İÇİN)		1 ad.	6.020
001 024 000008 00 00	ÇATI (8 MODÜL İÇİN)		1 ad.	6.880
001 024 000009 00 00	ÇATI (9 MODÜL İÇİN)		1 ad.	7.740
001 024 000010 00 00	ÇATI (10 MODÜL İÇİN)		1 ad.	8.600
888 049 050001	KESMESİZ MODÜL		10 ad.	2.00 USD.
888 049 050002	KESMELİ MODÜL		10 ad.	2.20 USD.
888 049 050003	İRTİBATLAMA ALETİ		1 ad.	8.50 USD.
031 049 040001	DAİRE İÇİ TLF.DĞT. KUTUSU (TEK JAKLI)		50 ad.	0.405 USD.
031 049 040002	DAİRE İÇİ TLF.DĞT. KUTUSU (ÇİFT JAKLI)		50 ad.	0.485 USD.
888 049 050005	TELEFON SİRİAL KORDONU		1 ad.	1.00 USD.
888 049 050006	TELEFON KÖKEN KORDON (TEK JAKLI)		1 ad.	0.650 USD.
888 049 050007	TELEFON KÖKEN KORDON (ÇİFT JAKLI)		1 ad.	0.787 USD.
888 101 010012	DATA+TEL. SIKMA PENSESİ 8P6P		1 ad.	12.870 USD.
888 049 050011	VT4001 4P4C PLUG		100 ad.	0.037 USD.
888 049 050010	VT4003 8P8C PLUG		100 ad.	0.085 USD.
888 049 050016	VT4006 4P4C SİRİAL KORUYUCU (FIRDÖNDÜ)		1 ad.	1.210 USD.
888 049 050018	VT4102 6P6C 2 LI DAĞITICI TEL.FİŞİ		1 ad.	0.506 USD.
888 049 050019	VT4104 6P4C PARALEL DAĞITICI		1 ad.	0.625 USD.

POLYESTER DAĞITIM PANOLARI

066 089 032030	T-5000-01 20X30X12 POLYESTER ETANJ PANO	1 ad.	36.000
066 089 032530	T-5000-02 25X30X17 POLYESTER ETANJ PANO	1 ad.	46.200
066 089 033040	T-5000-03 30X40X17 POLYESTER ETANJ PANO	1 ad.	64.800
066 089 033550	T-5000-04 35X50X17 POLYESTER ETANJ PANO	1 ad.	86.400
066 089 034060	T-5000-05 40X60X22 POLYESTER ETANJ PANO	1 ad.	97.800

POLYESTER ETANJ PANOLAR (POSEL)

009 089 001510	S/A TEKLİ SAYAÇ PANOSU MONOFAZE	1 ad.	33.000
009 089 152011	15X20X11 POLY. ETANJ PANO	1 ad.	25.080
009 089 162610	16X26X10 POLY. ETANJ PANO	1 ad.	26.400
009 089 202517	20X25X17 POLY. ETANJ PANO	1 ad.	36.960
009 089 202512	20X25X12 POLY. ETANJ PANO	1 ad.	36.960
009 089 203017	30X20X17 POLY. ETANJ PANO	1 ad.	38.280
009 089 203012	30X20X12 POLY. ETANJ PANO	1 ad.	38.280
009 089 253017	25X30X17 POLY. ETANJ PANO	1 ad.	43.560
009 089 253012	25X30X12 POLY. ETANJ PANO	1 ad.	43.560
009 089 304017	30X40X17 POLY. ETANJ PANO	1 ad.	58.080
009 089 304012	30X40X12 POLY. ETANJ PANO	1 ad.	58.080
009 089 355022	35X50X22 POLY. ETANJ PANO	1 ad.	83.160
009 089 355017	35X50X17 POLY. ETANJ PANO	1 ad.	83.160
009 089 406022	40X60X22 POLY. ETANJ PANO	1 ad.	91.080
009 089 406017	40X60X17 POLY. ETANJ PANO	1 ad.	91.080
009 089 406027	40X60X27 POLY. ETANJ PANO	1 ad.	129.360
009 089 508032	50X80X32 POLY. ETANJ PANO	1 ad.	224.400
009 089 701001	70X100X33 POLY. ETANJ PANO (TEK KAPI)	1 ad.	844.800
009 089 701002	70X100X33 POLY. ETANJ PANO (ÇİFT KAPI)	1 ad.	910.800



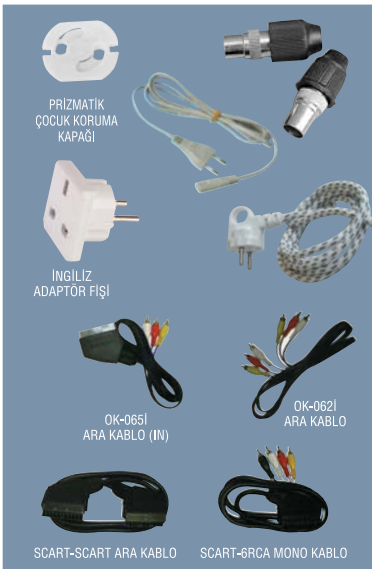
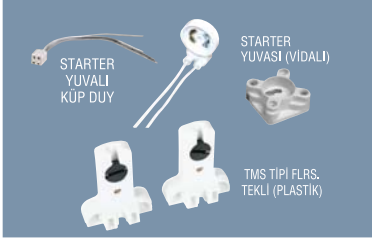

Ürün Kodu	Açıklama / Stok Cinsi	Ambalaj (Kutulu)	Ambalaj Birimi	TL
PLASTİK OPAK PANOLAR				
048 089 212813	21X28X13 PLASTİK OPAK PANO	1	ad.	34.500
048 089 253313	25X33X13 PLASTİK OPAK PANO	1	ad.	36.800
048 089 304017	30X40X16,5 PLASTİK OPAK PANO	1	ad.	52.900
048 089 405018	40X50X17,5 PLASTİK OPAK PANO	1	ad.	78.200
048 089 406020	40X60X20 PLASTİK OPAK PANO	1	ad.	92.000
048 089 507025	50X70X24,5 PLASTİK OPAK PANO	1	ad.	184.000
048 089 355020	35X50X19,5 PLASTİK OPAK PANO	1	ad.	80.500

DUYLAR				
040 109 040002	İTALYAN DUY E 27	50	ad.	1.225
040 109 040001	İTALYAN DUY E 14	100	ad.	1.125
040 109 040005	İTALYAN DUY RONDELASI E27	100	ad.	0.275
040 109 040003	İTALYAN DUY RONDELASI E14	100	ad.	0.213
040 109 030004	MİSFER E 27 BRONZ DUY	50	ad.	2.375
040 109 030003	MİSFER E 14 BRONZ DUY	100	ad.	2.250
024 109 010008	BAKALİT ASMA DUY	50	ad.	0.750
039 109 010009	PLASTİK MİNYONET DUY	100	ad.	0.188
039 109 010010	MİNYON DONANMA DUY	100	ad.	1.125
072 109 010001	DUVAR DUY	30	ad.	0.800
072 109 010002	TAVAN DUY	30	ad.	0.800
024 109 010004	TAVAN GLOP DİBİ	24	ad.	1.250
024 109 010003	DUVAR GLOP DİBİ	24	ad.	1.250
024 109 010005	YAĞMUR DUY	50	ad.	0.900
073 109 020001	150 W.ÇUBUK HALOJEN DUY TAKIMI	20	ad.	4.250
073 109 020002	500 W.ÇUBUK HALOJEN DUY TAKIMI	20	ad.	4.438
073 109 020003	1000 W.ÇUBUK HALOJEN DUY TAKIMI	20	ad.	4.625

FLORESANT SOKETLER				
004 078 000001	TMS TİPİ FLRS. TEKLİ (PLASTİK)	50	tkm.	1.700
004 078 000002	TMS TİPİ FLRS. SOKETİ ÇİFTLİ (PLASTİK)	25	tkm.	2.600
004 078 000003	TMS STARTER YUVASI (GEÇMELİ)	100	ad.	0.650
001 078 010004 00 00	VİDALI TİP AY AYAK	250	ad.	0.150
004 078 000004	STARTER YUVASI (VİDALI)	100	ad.	0.740
072 078 010003	SİMİT FLORESANT AY AYAK	250	ad.	0.055
076 109 010007	32 WAT SİMİT KÜP DUY	100	ad.	1.250
076 109 010006	STARTER YUVALI KÜP DUY	100	ad.	1.350

FİŞ ÇEŞİTLERİ				
023 109 000001	PRİZMATİK ÇOCUK KORUMA KAPAĞI	50	ad.	1.500
999 999 000187	180 cm. KABLOLU BASKILI ÜTÜ KABLOSU	1	ad.	4.625
999 999 000186	2 MT. KABLOLU BASKILI TEYP FİŞİ	1	ad.	2.750
024 109 060001	DUY FİŞ PERÇİNLİ	50	ad.	0.975
024 109 060002	DUY PRİZ	50	ad.	2.350
031 114 020001	TV ERKEK FİŞİ 1.KALİTE	100	ad.	1.125
031 114 020002	TV DIŞI FİŞİ 1.KALİTE	100	ad.	1.125
031 114 000050	OK-050 F KONNEKTÖR RG-6	1	ad.	0.375
031 114 000051	OK-051 F KONNEKTÖR RG-59	1	ad.	0.394
031 114 000057	OK-057 F ARA KONNEKTÖR	1	ad.	0.600
031 114 000062	OK-062İ 3RCA-3RCA ARA KABLO	1	ad.	0.735 USD.
031 114 000065	OK-065İ SCART-3RCA ARA KABLO (İN)	1	ad.	1.120 USD.
031 114 000063	OK-063İ SCART-SCART ARA KABLO	1	ad.	1.330 USD.
031 114 000064	OK-064İ SCART-6RCA MONO KABLO	1	ad.	1.295 USD.
031 114 000140	OK-140İ İNGİLİZ ADAPTÖR FİŞİ	50	ad.	2.500 USD.
031 114 000088	OK-88İ JAKLI TELEFON FİŞİ	50	ad.	0.613 USD.
031 114 000090	OK-90İ ADSL KUTUCUĞU	1	ad.	1.330 USD.
031 114 000040	OK-040İ PİPO TİPİ ANTEN FİŞİ ERKEK	1	ad.	0.144 USD.
031 114 000082	OK-082İ 6P4C DIŞI ARA ADAPTÖR	1	ad.	0.350 USD.
031 114 000085	OK-085İ 6P4C ERKEK+DIŞI+DIŞI+DIŞI	1	ad.	0.665 USD.
031 114 000086	OK-086İ 6P4C ERKEK+DIŞI+DIŞI+DIŞI+DIŞI	1	ad.	1.610 USD.

KONTROL KALEMLERİ				
104 119 000001	JUMBO DÜZ KONTROL KALEMİ	12	ad.	1.725
104 119 000002	JUMBO YILDIZ KONTROL KALEMİ	12	ad.	1.725
104 119 000003	COMBO DÜZ KONTROL KALEMİ	12	ad.	1.725
104 119 000004	COMBO YILDIZ KONTROL KALEMİ	12	ad.	1.725

Ürün Kodu	Açıklama / Stok Cinsi	Ambalaj (Kutulu)	Ambalaj Birimi	TL
KONTROL KALEMLERİ (İTHAL)				
888 119 010008	FHT-808A VOL.TEST K.KALEMİ AC/DC 100-250V	10	ad.	0.714 USD.
888 119 010003	FHT-159 VOL.TEST K.KALEMİ AC/DC 100-250V	12	ad.	0.777 USD.
888 119 010007	FHT-608 VOL.TEST K.KALEMİ AC/DC 100-250V	12	ad.	0.462 USD.
888 119 010006	FHT-304C VOL.TEST K.KALEMİ AC/DC 100-250V	12	ad.	0.462 USD.
888 119 010010	FHT-2006 VOL.TEST K.KAL.AC 110/220/380V	10	ad.	3.402 USD.
888 119 010011	FHT-9818 VOLTAJ TEST KONTROL KALEMİ	25	ad.	2.100 USD.
888 119 010012	FHT-9848 MULTI-FUNCTION ELECTRICAL TEST.	20	ad.	6.552 USD.
888 119 010002	FHT-030 9'LU TEST TAKIM KUTUSU	1	ad.	4.746 USD.
888 119 010001	FHT-023 KONTROL KALEMİ TAKIM KUTUSU	1	ad.	2.310 USD.
888 119 010004	FHT-232 VOL.TEST K.KALEMİ AC/DC 100-250V	20	ad.	1.680 USD.
888 119 010005	FHT-233 VOL.TEST K.KALEMİ AC/DC 100-250V	20	ad.	1.638 USD.
888 119 010009	FHT-828R DİJ.VOLT.TEST.12,36,55,110,220V	50	ad.	1.596 USD.
888 119 010013	FHT-601 İNCE TİP KONT.KALEMİ DÜZ AC/DC 100-500V	1	ad.	1.176 USD.
888 119 010014	FHT-611 İNCE TİP KONT. KALEMİ YILDIZ AC/DC 100-500V	1	ad.	1.176 USD.
888 119 010015	FHT-602 KALIN TİP KONT. KALEMİ DÜZ AC/DC 100-500V	1	ad.	1.260 USD.
888 119 010016	FHT-612 KALIN TİP KONT. KALEMİ YILDIZ AC/DC 100-500V	1	ad.	1.260 USD.
888 119 010018	FHT-958 KOPIK HAT DEDEKTÖRÜ	1	ad.	6.930 USD.

VIP-TEC KOMBİNE PENSE

105 101 210160	VT210160 VIP-TEC KOMBİNE PENSE	6	ad.	20.713
105 101 210180	VT210180 VIP-TEC KOMBİNE PENSE	6	ad.	23.650
105 101 210200	VT210200 VIP-TEC KOMBİNE PENSE	6	ad.	27.701
105 101 025160	VT215160 YAN KESKİ	6	ad.	20.852
105 101 025180	VT215180 YAN KESKİ	6	ad.	24.082
105 101 211160	VT211160 PLATINIUM KOMBİNE PENSE	6	ad.	27.701
105 101 211180	VT211180 PLATINIUM KOMBİNE PENSE	6	ad.	29.914
105 101 216160	VT216160 PLATINIUM YAN KESKİ	6	ad.	27.701
105 101 216180	VT216180 PLATINIUM YAN KESKİ	6	ad.	29.914

VIP-TEC TORNAVİDA VE PENSE TAKIMI

105 119 210309	VT210309 VIP-TEC TORNAVİDA VE PENSE TAKIMI	1	ad.	105.653
105 119 200309	VT200309 VIP-TEC TORNAVİDA VE PENSE TAKIMI	1	ad.	139.339
105 101 700050	VT7100 BİTS TORNAVİDA SETİ-DEPOLU 6 LI DEĞİŞGEN UC	1	ad.	18.528

VIP-TEC DÜZ UÇLU TORNAVİDA

105 101 610031	6100/31 DÜZ UÇLU TORNAVİDA	12	ad.	3.174
105 101 610042	6100/42 DÜZ UÇLU TORNAVİDA	12	ad.	5.345
105 101 610052	6100/52 DÜZ UÇLU TORNAVİDA	12	ad.	6.194
105 101 610063	6100/63 DÜZ UÇLU TORNAVİDA	12	ad.	7.851

VIP-TEC YILDIZ UÇLU TORNAVİDA

105 101 620031	6200/31 YILDIZ UÇLU TORNAVİDA	12	ad.	3.480
105 101 620042	6200/42 YILDIZ UÇLU TORNAVİDA	12	ad.	5.345
105 101 620051	6200/51 YILDIZ UÇLU TORNAVİDA	12	ad.	5.526
105 101 620063	6200/63 YILDIZ UÇLU TORNAVİDA	12	ad.	7.670

VIP-TEC KONTROL KALEMİ

105 119 006190	VT/6190 VIP-TEC DÜZ UÇLU KONTROL KALEMİ DÜZ	24	ad.	5.596
105 119 006191	VT/6191 VIP-TEC KONTROL KALEMİ YILDIZ	24	ad.	5.596

VIP-TEC MULTİBAG TAKIM ÇANTALARI

105 101 201310	VT201310 1000 VOLT İZOLELİ PENSE-TORNAVİDA ÇANT.10 PARÇA	1	ad.	243.099
105 101 201309	VT201309 1000 VOLT İZOLELİ PENSE-TORNAVİDA ÇANT.9 PARÇA	1	ad.	161.500
105 101 210318	VT210318 JUMBO TAKIM 9 PARÇA	1	ad.	260.165

VIP-TEC 1000V İZOLELİ DÜZ UÇLU TORNAVİDA

105 101 810032	8100/32 1000V İZOLELİ DÜZ UÇLU TORNAVİDA,	1	ad.	6.515
105 101 810042	8100/42 1000V İZOLELİ DÜZ UÇLU TORNAVİDA,	1	ad.	8.728
105 101 810053	8100/53 1000V İZOLELİ DÜZ UÇLU TORNAVİDA,	1	ad.	10.106
105 101 810064	8100/64 1000V İZOLELİ DÜZ UÇLU TORNAVİDA,	1	ad.	12.250

VIP-TEC 1000V İZOLELİ YILDIZ UÇLU TORNAVİDA

105 101 820030	8200/30 1000V İZOLELİ YILDIZ UÇLU TORNAVİDA,	1	ad.	6.069
105 101 820041	8200/41 1000V İZOLELİ YILDIZ UÇLU TORNAVİDA,	1	ad.	8.115
105 101 820062	8200/62 1000V İZOLELİ YILDIZ UÇLU TORNAVİDA,	1	ad.	10.565
105 101 820084	8200/84 1000V İZOLELİ YILDIZ UÇLU TORNAVİDA,	1	ad.	16.078

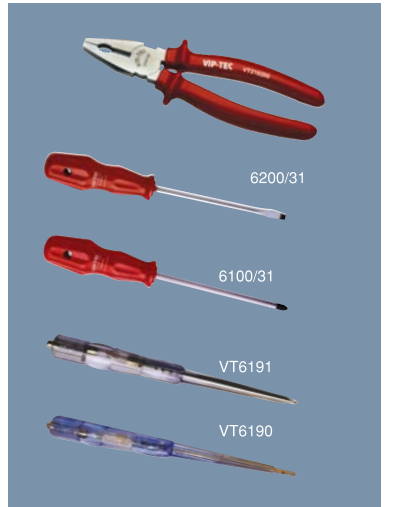

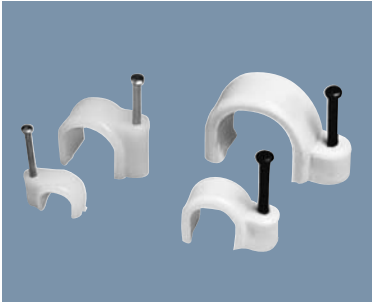
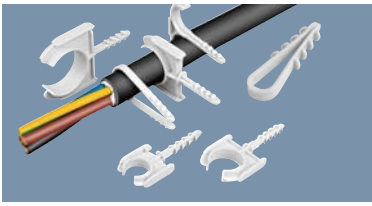
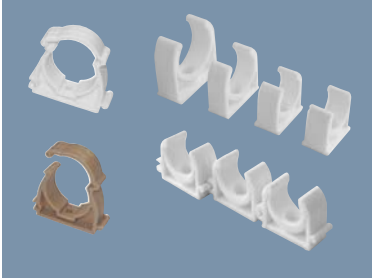

Ürün Kodu	Açıklama / Stok Cinsi	Ambalaj (Kutulu)	Ambalaj Birimi	TL
VIP-TEC 1000V İZOLELİ PENSELER				
105 101 300001	VT205160 1000V İZOLELİ KOMBİNE PENSE	6	ad.	30.598
105 101 300002	VT205180 1000V İZOLELİ KOMBİNE PENSE	6	ad.	32.422
105 101 300003	VT206160 1000V İZOLELİ YAN KESKİ	6	ad.	30.598
105 101 300004	VT206180 1000V İZOLELİ YAN KESKİ	6	ad.	32.422
105 101 300005	VT208160 1000V İZOLELİ EĞRİ KARGA BURUN	6	ad.	28.106
ANTİGRON KROŞELER				
128 048 000001	NO:1 ANT. KROŞE(2X1.5-2X2.5-3X1.5-3X2.5)	100	ad.	0.094
128 048 000015	NO: 1.5 ANTİGRON KROŞE (2X4-2X6-4X4-4X6)	100	ad.	0.101
128 048 000002	NO: 2 ANTİGRON KROŞELER (4X10)	100	ad.	0.156
128 048 000003	NO: 3 ANTİGRON KROŞELER (4X16-3X25+16)	50	ad.	0.228
GEÇMELİ TİP ANTİGRON BORU KROŞELERİ				
001 048 010016 00 17	16'LİK ANTİGRON BORU KROŞESİ (GEÇMELİ TİP)	100	ad.	0.106
001 048 010018 00 17	18'LİK ANTİGRON BORU KROŞESİ (GEÇMELİ TİP)	100	ad.	0.106
001 048 010020 00 17	20'LİK ANTİGRON BORU KROŞESİ (GEÇMELİ TİP)	100	ad.	0.106
001 048 010025 00 17	25'LİK ANTİGRON BORU KROŞESİ (GEÇMELİ TİP)	100	ad.	0.125
001 048 010032 00 17	32'LİK ANTİGRON BORU KROŞESİ (GEÇMELİ TİP)	100	ad.	0.210
001 048 010040 00 17	40'LİK ANTİGRON BORU KROŞESİ (GEÇMELİ TİP)	50	ad.	0.280
074 048 050016	16 LİK ANTİGRON BORU KROŞESİ (GEÇMELİ TİP) KAPAKLI	100	ad.	0.154
074 048 050017	20 LİK ANTİGRON BORU KROŞESİ (GEÇMELİ TİP) KAPAKLI	100	ad.	0.154
074 048 050025	25LİK ANTİGRON BORU KROŞESİ (GEÇMELİ TİP) KAPAKLI	100	ad.	0.182
DÜBELLİ KROŞELER				
001 048 090002 00 17	3/13 TEKLİ KABLO KROŞESİ	500	ad.	0.077
001 048 090006 00 17	8/28 TEKLİ KABLO KROŞESİ	500	ad.	0.103
001 048 090001 00 00	ÇİFTLİ KABLO KROŞESİ	200	ad.	0.129
001 048 090003 00 17	16'LİK BORU KELEPÇESİ	100	ad.	0.180
001 048 090004 00 17	20'LİK BORU KELEPÇESİ	100	ad.	0.206
001 048 090005 00 17	25'LİK BORU KELEPÇESİ	100	ad.	0.245
BETON ÇİVİLİ KROŞELER				
032 048 080000	NO:0 BETON ÇİVİLİ KROŞE(0.75 YASSIKORD.)	1000	ad.	0.015
032 048 080001	NO:1 BETON ÇİVİLİ KROŞE(0.75 YASSIKORD.)	1000	ad.	0.015
032 048 080002	NO:2 BETON ÇİVİLİ KROŞE(0.75 YASSIKORD.)	1000	ad.	0.015
032 048 080003	NO. 3 BETON ÇİVİLİ KROŞE (2X1.5-3X1.5)	1000	ad.	0.020
032 048 080004	NO. 4 BETON ÇİVİLİ KROŞE (2X4)	1000	ad.	0.020
032 048 080005	NO. 5 BETON ÇİVİLİ KROŞE (2X4-4X4)	1000	ad.	0.028
032 048 080006	NO. 6 BETON ÇİVİLİ KROŞE (2X6)	1000	ad.	0.028
032 048 080007	NO. 7 BETON ÇİVİLİ KROŞE (4X10)	800	ad.	0.060
032 048 080008	NO. 8 BETON ÇİVİLİ KROŞE (3X16+10)	400	ad.	0.075
032 048 080009	NO. 9 BETON ÇİVİLİ KROŞE (3X25+16)	400	ad.	0.095
GALVANİZLİ SAÇ KROŞELER				
001 048 060001 00 00	NO. 1 TEKLİ GALVANİZ SAÇ KROŞE 12MM	1500	ad.	0.050
001 048 060002 00 00	NO. 2 TEKLİ GALVANİZ SAÇ KROŞE 14MM	1000	ad.	0.071
001 048 060003 00 00	NO. 3 TEKLİ GALVANİZ SAÇ KROŞE 17MM	700	ad.	0.087
001 048 060004 00 00	NO. 4 TEKLİ GALVANİZ SAÇ KROŞE 20MM	500	ad.	0.106
001 048 060007 00 00	NO. 7 TEKLİ GALVANİZ SAÇ KROŞE 26MM	350	ad.	0.136
001 048 060008 00 00	NO. 8 TEKLİ GALVANİZ SAÇ KROŞE 34MM	250	ad.	0.180
001 048 060009 00 00	NO. 9 TEKLİ GALVANİZ SAÇ KROŞE 43MM	200	ad.	0.206
001 048 060010 00 00	NO. 10 TEKLİ GALVANİZ SAÇ KROŞE 53MM	150	ad.	0.211
001 048 070002 00 00	NO. 2 ÇİFTLİ GALVANİZ SAÇ KROŞE 13MM	600	ad.	0.092
001 048 070003 00 00	NO. 3 ÇİFTLİ GALVANİZ SAÇ KROŞE 16MM	500	ad.	0.110
001 048 070004 00 00	NO. 4 ÇİFTLİ GALVANİZ SAÇ KROŞE 22MM	400	ad.	0.128
001 048 070007 00 00	NO. 7 ÇİFTLİ GALVANİZ SAÇ KROŞE 25MM	400	ad.	0.145
001 048 070008 00 00	NO. 8 ÇİFTLİ GALVANİZ SAÇ KROŞE 35MM	300	ad.	0.193
001 048 070009 00 00	NO. 9 ÇİFTLİ GALVANİZ SAÇ KROŞE 45MM	200	ad.	0.229
001 048 070010 00 00	NO. 10 ÇİFTLİ GALVANİZ SAÇ KROŞE 50MM	150	ad.	0.244
001 048 070011 00 00	NO. 11 ÇİFTLİ GALVANİZ SAÇ KROŞE 55MM	100	ad.	0.283

Ürün Kodu	Açıklama / Stok Cinsi	Ambalaj (Kutulu)	Ambalaj Birimi	TL
P KLİPS ÇEŞİTLERİ				
106 048 000001	P-1 KLİPS	100	ad.	0.326
106 048 000002	P-2 KLİPS	100	ad.	0.336
106 048 000003	P-3 KLİPS	100	ad.	0.346
106 048 000004	P-4 KLİPS	100	ad.	0.358
106 048 000005	P-5 KLİPS	100	ad.	0.384
106 048 000006	P-6 KLİPS	100	ad.	0.406
106 048 000007	P-7 KLİPS	100	ad.	0.442
106 048 000008	P-8 KLİPS	100	ad.	0.478
106 048 000009	P-9 KLİPS	100	ad.	0.535
106 048 000010	P-10 KLİPS	100	ad.	0.557

RAY KROŞE VE TANDIR KROŞELER				
035 048 100001	NO. 1 RAY KROŞE (2X1.5-4X2.5)	350	ad.	0.225
035 048 100002	NO. 2 RAY KROŞE (4X4-4X16)	250	ad.	0.241
001 025 010100 00 00	GALVANİZ KROŞE RAYI (1M)	50	ad.	2.100
035 048 110001	NO. 1 TANDIR KROŞE (2X1.5-2X6)	350	ad.	0.179
035 048 110002	NO. 2 TANDIR KROŞE (4X6)	250	ad.	0.179
035 048 110003	NO. 3 TANDIR KROŞE (4X10)	250	ad.	0.179
035 048 110004	NO. 4 TANDIR KROŞE (4X16)	150	ad.	0.225
035 048 110005	NO. 5 TANDIR KROŞE (3X25+16)	150	ad.	0.225

PLASTİK DÜBELLER				
016 053 000014	BURGULU ALÇIBAN DÜBELİ (YENİ)	100	ad.	0.060
016 053 308100	8X100MM BOŞLUK DÜBELİ	100	ad.	0.090
001 053 000001 00 00	ALÇIPAN DÜBEL	1000	ad.	0.060
016 053 100002	MEGA DÜBEL	1000	ad.	0.040
001 053 000002 00 00	KANAL DÜBELİ	1000	ad.	0.040
888 129 080185	DÜBELLİ KABLO BAĞI 8X18,5	100	ad.	0.190
001 053 000005 00 00	KORNİŞ DÜBELİ	1000	ad.	0.043
016 053 000006	6 MM BEYAZ DÜBEL	1000	ad.	0.014
016 053 000007	7 MM BEYAZ DÜBEL	1000	ad.	0.015
016 053 000008	8 MM BEYAZ DÜBEL	1000	ad.	0.016
016 053 000010	10 MM BEYAZ DÜBEL	1000	ad.	0.035
016 053 000012	12 MM BEYAZ DÜBEL	250	ad.	0.045
016 053 000106	6 MM RENKLİ DÜBEL (YEŞİL)	1000	ad.	0.020
016 053 000107	7 MM RENKLİ DÜBEL (SARI)	1000	ad.	0.021
016 053 000108	8 MM RENKLİ DÜBEL (KIRMIZI)	1000	ad.	0.030
016 053 000110	10 MM RENKLİ DÜBEL (MAVİ)	1000	ad.	0.050
016 053 300008	8 MM ROKET DÜBEL	1000	ad.	0.070
016 053 300010	10 MM ROKET DÜBEL	500	ad.	0.090

KANCA VİDALAR				
013 099 031860	18X60 KANCA VİDA (144 ADET)	1	grs.	12.800
013 099 031960	19X60 KANCA VİDA (144 ADET)	1	grs.	17.000
013 099 031970	19X70 KANCA VİDA (144 ADET)	1	grs.	17.300
013 099 032060	20X60 KANCA VİDA (144 ADET)	1	grs.	18.300
013 099 032070	20X70 KANCA VİDA (144 ADET)	1	grs.	19.000
013 099 032080	20X80 KANCA VİDA (100 ADET)	1	grs.	13.600
013 099 032180	21X80 KANCA VİDA (100 ADET)	1	grs.	15.400

YILDIZ BAŞLI AĞAÇ VİDALARI				
013 099 011717	17X17 VİDA YILDIZ BAŞLI	12	grs.	2.130
013 099 011820	18X20 VİDA YILDIZ BAŞLI	12	grs.	2.280
013 099 011825	18X25 VİDA YILDIZ BAŞLI	12	grs.	2.760
013 099 011830	18X30 VİDA YILDIZ BAŞLI	12	grs.	3.350
013 099 011835	18X35 VİDA YILDIZ BAŞLI	12	grs.	3.650
013 099 011840	18X40 VİDA YILDIZ BAŞLI	12	grs.	3.850
013 099 011845	18X45 VİDA YILDIZ BAŞLI	12	grs.	4.430
013 099 011850	18X50 VİDA YILDIZ BAŞLI	12	grs.	4.720
013 099 011920	19X20 VİDA YILDIZ BAŞLI	12	grs.	2.940
013 099 011925	19X25 VİDA YILDIZ BAŞLI	12	grs.	3.200
013 099 011930	19X30 VİDA YILDIZ BAŞLI	12	grs.	3.970
013 099 011935	19X35 VİDA YILDIZ BAŞLI	12	grs.	4.440
013 099 011940	19X40 VİDA YILDIZ BAŞLI	12	grs.	4.890
013 099 011945	19X45 VİDA YILDIZ BAŞLI	12	grs.	5.400
013 099 011950	19X50 VİDA YILDIZ BAŞLI	12	grs.	5.750
013 099 012020	20X20 VİDA YILDIZ BAŞLI	12	grs.	3.800
013 099 012025	20X25 VİDA YILDIZ BAŞLI	12	grs.	4.260
013 099 012030	20X30 VİDA YILDIZ BAŞLI	12	grs.	5.000
013 099 012035	20X35 VİDA YILDIZ BAŞLI	12	grs.	5.580
013 099 012040	20X40 VİDA YILDIZ BAŞLI	12	grs.	6.100
013 099 012045	20X45 VİDA YILDIZ BAŞLI	12	grs.	6.750
013 099 012050	20X50 VİDA YILDIZ BAŞLI	12	grs.	7.250
013 099 012060	20X60 VİDA YILDIZ BAŞLI	12	grs.	8.500

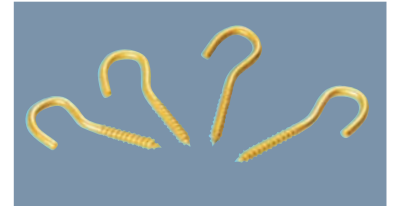
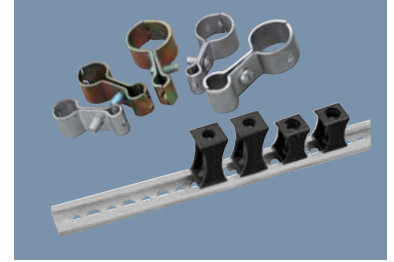
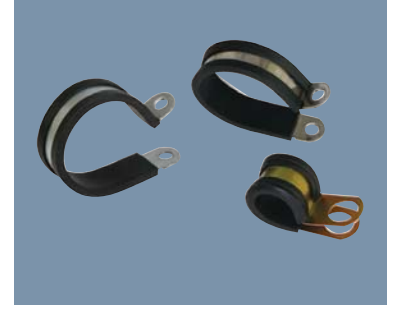



Ürün Kodu	Açıklama / Stok Cinsi	Ambalaj (Kutulu)	Ambalaj Birimi	TL
SUNTA VİDASI ÇİNKO KAPLAMA				
013 099 040316	3X16 SUNTA VİDASI (1000 ADET)	1	grs.	12.900
013 099 040320	3X20 SUNTA VİDASI (1000 ADET)	1	grs.	14.430
013 099 040325	3X25 SUNTA VİDASI (1000 ADET)	1	grs.	17.340
013 099 040330	3X30 SUNTA VİDASI (1000 ADET)	1	grs.	21.420
013 099 043513	3,5X13 SUNTA VİDASI (1000 ADET)	1	grs.	17.100
013 099 043516	3,5X16 SUNTA VİDASI (1000 ADET)	1	grs.	17.600
013 099 043518	3,5X18 SUNTA VİDASI (1000 ADET)	1	grs.	18.870
013 099 043520	3,5X20 SUNTA VİDASI (1000 ADET)	1	grs.	18.970
013 099 043525	3,5X25 SUNTA VİDASI (1000 ADET)	1	grs.	20.300
013 099 043530	3,5X30 SUNTA VİDASI (1000 ADET)	1	grs.	25.500
013 099 043535	3,5X35 SUNTA VİDASI (1000 ADET)	1	grs.	28.560
013 099 043540	3,5X40 SUNTA VİDASI (500 ADET)	1	grs.	15.560
013 099 040416	4X16 SUNTA VİDASI (1000 ADET)	1	grs.	19.230
013 099 040420	4X20 SUNTA VİDASI (1000 ADET)	1	grs.	23.560
013 099 040425	4X25 SUNTA VİDASI (500 ADET)	1	grs.	14.280
013 099 040430	4X30 SUNTA VİDASI (500 ADET)	1	grs.	15.980
013 099 040435	4X35 SUNTA VİDASI (500 ADET)	1	grs.	17.850
013 099 040440	4X40 SUNTA VİDASI (500 ADET)	1	grs.	20.250
013 099 040445	4X45 SUNTA VİDASI (500 ADET)	1	grs.	21.520
013 099 040460	4X60 SUNTA VİDASI (200 ADET)	1	grs.	10.800
013 099 040450	4X50 SUNTA VİDASI (500 ADET)	1	grs.	23.250
013 099 044460	4,5X60 SUNTA VİDASI (200 ADET)	1	grs.	13.360
013 099 044530	4,5X30 SUNTA VİDASI (500 ADET)	1	grs.	20.250
013 099 044535	4,5X35 SUNTA VİDASI (200 ADET)	1	grs.	8.925
013 099 044540	4,5X40 SUNTA VİDASI (200 ADET)	1	grs.	9.740
013 099 044545	4,5X45 SUNTA VİDASI (200 ADET)	1	grs.	10.450
013 099 044550	4,5X50 SUNTA VİDASI (200 ADET)	1	grs.	11.630
013 099 040530	5X30 SUNTA VİDASI (200 ADET)	1	grs.	9.200
013 099 040535	5X35 SUNTA VİDASI (200 ADET)	1	grs.	11.220
013 099 040540	5X40 SUNTA VİDASI (200 ADET)	1	grs.	11.830
013 099 040545	5X45 SUNTA VİDASI (200 ADET)	1	grs.	13.260
013 099 040550	5X50 SUNTA VİDASI (200 ADET)	1	grs.	15.150
013 099 040560	5X60 SUNTA VİDASI (200 ADET)	1	grs.	16.220

AKILLI MERD.OTO.-ZAMAN ROLESİ (TELE-HAASE/AVUS.)

054 126 010001	E1ZTP-230VAC AKILLI MERDİVEN OTOMATIĞI MULTİFONKSİYON	1	ad.	26.400 EUR.
054 126 010002	E1ZM10-24/240V AC/DC 7 FONKSİYON MULTİ ZAMAN ROLESİ	1	ad.	34.320 EUR.
054 126 010003	E1ZMQ10-24/240V AC/DC 6 FONKSİYON MULTİ ZAMAN ROLESİ	1	ad.	31.680 EUR.
054 126 010004	E1Z110-12/240V AC/DC ASİMETRİK FLAŞÖR ZAMAN ROLESİ	1	ad.	44.880 EUR.
054 126 010005	E19F400-ASİMETRİK AYARLI FAZ SIRALI FAZ KORUMA ROLESİ	1	ad.	31.680 EUR.
054 126 010006	E1Z1E10-24/240V AC/DC ON DELAY ZAMAN ROLESİ	1	ad.	26.400 EUR.

ZAMAN SAATLERİ (THEBEN)

074 158 000180	SUL-180 A MEKANİK ZAMAN SAATİ	1	ad.	64.800
074 158 000026	TIMER 26 PRİZ TİPİ MEKANİK ZAMAN SAATİ	1	ad.	44.880
074 158 000170	SELEKTA 170 TOP2 ASTRONOMİK ZAMAN SAATİ (TEK KANAL)	1	ad.	223.872
074 158 000172	SELEKTA 172 TOP2 ASTRONOMİK ZAMAN SAATİ (İKİ KANAL)	1	ad.	307.824
074 158 000001	OBELİSK HAFIZA KARTI (FLASH BELLEK)	1	ad.	72.744



Ürün Kodu	Açıklama / Stok Cinsi	Ambalaj (Kutulu)	Ambalaj Birimi	TL
İTHAL ŞEFFAF ISIYA DAYANIKLI SIRA KLEMESLER				
888 094 000105	DG1.5T-10P SIRA KLEMENS	50	ad.	0.530 USD.
888 094 000205	DG2.5T-10P SIRA KLEMENS	50	ad.	0.600 USD.
888 094 000405	DG4.5T-10P SIRA KLEMENS	50	ad.	0.730 USD.
888 094 000605	DG6.5T-10P SIRA KLEMENS	50	ad.	1.060 USD.
PLASTİK SIRA KLEMENSLER				
015 094 150000	NO. 0 SIRA KLEMENSLER	50	ad.	1.513
015 094 150001	NO. 1 SIRA KLEMENSLER (2.5-4 MM2)	50	ad.	1.513
015 094 150002	NO. 2 SIRA KLEMENSLER (4-6 MM2)	50	ad.	1.913
015 094 150003	NO. 3 SIRA KLEMENSLER (10-16 MM2)	50	ad.	2.525
015 094 150004	NO. 4 SIRA KLEMENSLER (16-25 MM2)	50	ad.	2.838
YANMAZ SIRA KLEMENSLER				
015 094 170000	NO. 0 ISIYA DAYANIKLI KLEMENSLER	50	ad.	1.763
015 094 170001	NO. 1 ISIYA DAYANIKLI KLEMENSLER (2.5-4 MM2)	50	ad.	1.763
015 094 170002	NO. 2 ISIYA DAYANIKLI KLEMENSLER (4-6 MM2)	50	ad.	2.238
015 094 170003	NO. 3 ISIYA DAYANIKLI KLEMENSLER (10-16 MM2)	50	ad.	3.063
015 094 170004	NO. 4 ISIYA DAYANIKLI KLEMENSLER (16-25 MM2)	50	ad.	3.538
PORSELEN KLEMENSLER				
015 094 180002	NO. 1-2'Lİ PORSELEN KLEMENS	150	ad.	0.688
015 094 180003	NO. 1-3'LÜ PORSELEN KLEMENS	100	ad.	0.963
015 094 180004	NO. 2-2'Lİ PORSELEN KLEMENS	100	ad.	0.900
015 094 180005	NO. 2-3'LÜ PORSELEN KLEMENS	60	ad.	1.238
015 094 180006	NO. 3-2'Lİ PORSELEN KLEMENS	60	ad.	1.238
U KLEMENSLER				
014 094 030006	6'LİK U KLEMENSİ	150	ad.	1.584
014 094 030010	10'LÜK U KLEMENSİ	125	ad.	1.944
014 094 030016	16'LİK U KLEMENSİ	100	ad.	2.904
014 094 030025	25'LİK U KLEMENSİ	100	ad.	3.552
014 094 030035	35'LİK U KLEMENSİ	75	ad.	4.128
014 094 030050	50'LİK U KLEMENSİ	50	ad.	6.240
014 094 030070	70'LİK U KLEMENSİ	40	ad.	7.080
014 094 030095	95'LİK U KLEMENSİ	25	ad.	10.272
014 094 030120	120'LİK U KLEMENSİ	10	ad.	13.656
014 094 030150	150'LİK U KLEMENSİ	10	ad.	17.040
MOTOR KLEMENSLER				
022 094 200001	NO. 1 MOTOR KLEMENS	150	ad.	1.620
022 094 200002	NO. 2 MOTOR KLEMENS	100	ad.	1.871
022 094 200003	NO. 3 MOTOR KLEMENS	100	ad.	2.424
022 094 200004	NO. 4 MOTOR KLEMENS	50	ad.	3.528
022 094 200005	NO. 5 MOTOR KLEMENS	30	ad.	6.552
022 094 200006	NO. 6 MOTOR KLEMENS	16	ad.	10.284
TIRNAKLI KLEMENSLER				
014 094 100001	NO:1 TIRNAKLI KLEMENS	500	ad.	1.704
014 094 100002	NO:2 TIRNAKLI KLEMENS	250	ad.	2.184
014 094 100003	NO:3 TIRNAKLI KLEMENS	100	ad.	3.120
014 094 100004	NO:4 TIRNAKLI KLEMENS	100	ad.	4.560
014 094 100005	NO:5 TIRNAKLI KLEMENS	100	ad.	5.568
014 094 100006	NO:6-7 TIRNAKLI KLEMENS	50	ad.	12.288

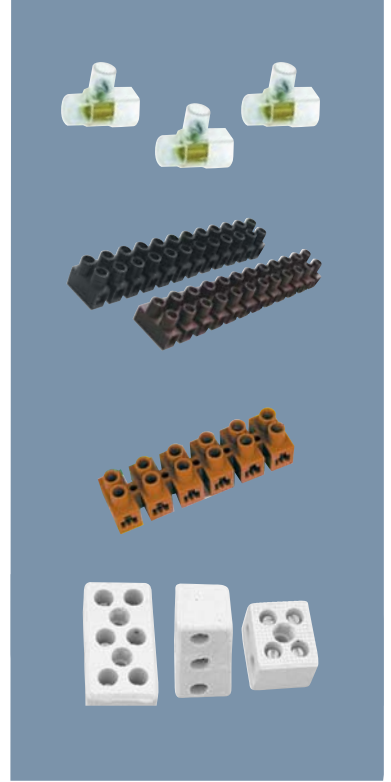

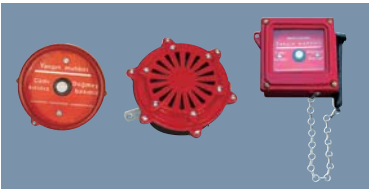

Ürün Kodu	Açıklama / Stok Cinsi	Ambalaj (Kutulu)	Ambalaj Birimi	TL
KAPI VE MERDİVEN OTOMATIĞI				
027 112 00001	GİZLİ KAPI OTOMATIĞI (DOKUNMATİK)	1	ad.	35.000
027 112 00002	GİZLİ KAPI OTOMATIĞI (BASMATİK)	1	ad.	32.500
027 112 00007	ELEK. KİLİTLİ (ANAHTARLI) KAPI OTOMATIĞI	1	ad.	70.000
027 112 00003	BUTONLU KAPI OTOMATIĞI	1	ad.	23.750
028 112 00004	KAPI OTOMATIĞI (NORMAL)	1	ad.	22.500
027 112 00005	MERDİVEN OTOMATIĞI (RAYLI)	1	ad.	15.000
027 112 00006	MERDİVEN OTOMATIĞI (NORMAL)	1	ad.	15.000
ZİL BUTONU ÇEŞİTLERİ				
037 106 02001	1'Lİ ALÜMİNYUM ZİL BUTONU 1.KALİTE	1	ad.	2.880
037 106 02002	2'Lİ ALÜMİNYUM ZİL BUTONU 1.KALİTE	1	ad.	5.760
037 106 02003	3'LÜ ALÜMİNYUM ZİL BUTONU 1.KALİTE	1	ad.	8.640
037 106 02004	4'LÜ ALÜMİNYUM ZİL BUTONU 1.KALİTE	1	ad.	11.520
037 106 02005	5'Lİ ALÜMİNYUM ZİL BUTONU 1.KALİTE	1	ad.	14.400
037 106 02006	6'Lİ ALÜMİNYUM ZİL BUTONU 1.KALİTE	1	ad.	17.280
037 106 02007	7'Lİ ALÜMİNYUM ZİL BUTONU 1.KALİTE	1	ad.	20.160
037 106 02008	8'Lİ ALÜMİNYUM ZİL BUTONU 1.KALİTE	1	ad.	23.040
037 106 02009	9'LU ALÜMİNYUM ZİL BUTONU 1.KALİTE	1	ad.	25.920
037 106 02010	10'LU ALÜMİNYUM ZİL BUTONU 1.KALİTE	1	ad.	28.800
039 106 03002	ETİKETLİ ZİL BUTONU (PLASTİK)	50	ad.	0.960
ZİLLER VE ZİL TRAFOLARI				
027 105 010012	ZİL TRAFOSU 12 V	1	ad.	8.190
027 105 010015	ZİL TRAFOSU 15 V	1	ad.	16.120
018 105 00008	PLA ZİL YASSI BOBİNLİ 4-8-12 V.	1	ad.	23.400
028 105 02003	KAMPANA ZİL 220 V	1	ad.	26.520
028 105 02004	KAMPANA ZİL 12V, 24V, 110V	1	ad.	33.800
028 105 02000	MUNZAM ZİL ROLESİ	1	ad.	19.500
018 105 00006	KANARYA ZİL (TEK SES)	1	ad.	5.760
018 105 00007	KANARYA ZİL (ÜÇ SES)	1	ad.	6.050
018 105 00001	TELEFON ZİLİ (AYARLI)	1	ad.	7.920
018 105 00002	DİNG DONG ZİL ELEKTRONİK (3 SES)	1	ad.	9.000
018 105 00003	MEKANİK DİNG DONG ZİL	1	ad.	15.000
018 105 00004	KONUŞAN ZİL 120 MELODİ	1	ad.	39.000
018 105 00005	MELODİLİ ZİL 16 MELODİ	1	ad.	13.260
999 999 000508	UZAKTAN KUMANDALI ZİL	1	ad.	21.000
DİYAFON MERKEZİ VE ŞUBELERİ				
018 104 00001	DİYAFON MERKEZİ 1"Lİ	1	ad.	46.800
018 104 00002	DİYAFON MERKEZİ 2"Lİ	1	ad.	46.800
018 104 00003	DİYAFON MERKEZİ 3"LÜ	1	ad.	46.800
018 104 00004	DİYAFON MERKEZİ 4"LÜ	1	ad.	46.800
018 104 00005	DİYAFON MERKEZİ 5'Lİ	1	ad.	46.800
018 104 00009	DİYAFON ŞUBESİ	1	ad.	5.200
İTHAL ÜRÜNLERİMİZ				
999 999 000080	KABLOLU GAZ DEDEKTÖRÜ	1	ad.	26.500
999 999 000081	9V PİLLİ DUMAN DEDEKTÖRÜ	1	ad.	15.400 USD
999 999 000264	PARA KONTROL CİHAZI 2X6W.+6W BLB AMPÜL	1	ad.	28.160 USD
888 038 250023	180 DERECE PIR HAREKET SENSÖRÜ	1	ad.	15.400 USD
888 038 250027	360 DERECE PIR HAREKET SENSÖRÜ	1	ad.	15.400 USD
999 133 011019	ERİYENT BANT	1	ad.	2.328 USD
065 133 001019	10X19 İZOLE BANT	1	ad.	0.422 USD
065 133 020000	ÇİFT TARAFLI BANT 1mm 20mm*50mt	50	ad.	4.800 EUR.
065 133 020003	ÇİFT TARAFLI BANT 1mm 25mm*50mt	50	ad.	6.000 EUR.
065 133 020001	ÇİFT TARAFLI BANT 1mm 30mm*50mt	50	ad.	7.200 EUR.
ALARM KORNA VE YANGIN İHBAR BUTONU				
028 120 00001	YANGIN İHBAR BUTONU (KARE)	2	ad.	11.700
028 120 00002	YANGIN İHBAR BUTONU (YUVARLAK)	2	ad.	5.460
028 120 00003	YANGIN İHBAR BUTONU DÖKÜM ÇEKİÇLİ	2	ad.	65.000
028 120 010001	ALARM KORNA (PLASTİK) 220V	1	ad.	15.600
028 120 010002	ALARM KORNA (DÖKÜM) 220V	1	ad.	18.200
028 120 010003	ALARM KORNA (PLASTİK) 12V, 24V, 110V	1	ad.	25.000

Ürün Kodu	Açıklama / Stok Cinsi	Ambalaj (Kutulu)	Ambalaj Birimi	Fiyat
YANGIN İHBAR KONTROL PANELLERİ-STANDART LED'Lİ				
006 086 601004	ECPN-1004 4 ZONLU KONTROL PANELİ LED GÖSTERGELİ	1	ad.	225.500 USD.
006 086 601008	ECPN-1008 8 ZONLU KONTROL PANELİ LED GÖSTERGELİ	1	ad.	243.950 USD.
006 086 601012	ECPN-1012 12 ZONLU KONTROL PANELİ LED GÖSTERGELİ	1	ad.	262.400 USD.
006 086 601016	ECPN-1016 16 ZONLU KONTROL PANELİ LED GÖSTERGELİ	1	ad.	280.850 USD.
006 086 601020	ECPN-1020 20 ZONLU KONTROL PANELİ LED GÖSTERGELİ	1	ad.	299.300 USD.
006 086 601024	ECPN-1024 24 ZONLU KONTROL PANELİ LED GÖSTERGELİ	1	ad.	317.750 USD.
006 086 601028	ECPN-1028 28 ZONLU KONTROL PANELİ LED GÖSTERGELİ	1	ad.	336.200 USD.
006 086 601032	ECPN-1032 32 ZONLU KONTROL PANELİ LED GÖSTERGELİ	1	ad.	354.650 USD.
YANGIN İHBAR KONTROL PANELLERİ-STANDART TİP				
006 086 001006	ECP-1006 6 ZONLU YNG.KONT.PANELİ STND.	1	ad.	225.500 USD.
006 086 001012	ECP-1012 12 ZONLU YNG.KONT.PANELİ STND.	1	ad.	256.250 USD.
006 086 001018	ECP-1018 18 ZONLU YNG.KONT.PANELİ STND.	1	ad.	276.750 USD.
YANGIN İHBAR KONTROL PANELLERİ-DIGITAL-MİKRO				
006 086 001008	ECP-1008 8 ZONLU YNG.KONT.PANELİ DIGIT.	1	ad.	297.250 USD.
006 086 001016	ECP-1016 16 ZONLU YNG.KONT.PANELİ DIGIT.	1	ad.	328.000 USD.
006 086 001024	ECP-1024 24 ZONLU YNG.KONT.PANELİ DIGIT.	1	ad.	358.750 USD.
006 086 001032	ECP-1032 32 ZONLU YNG.KONT.PANELİ DIGIT.	1	ad.	389.500 USD.
KURU VE SIZDIRMAZ TİP BAKIM GEREKTİRMİYEN AKÜLER				
006 086 101220	BAT-1220 12V / 2AH. KURU TİP AKÜ	1	ad.	29.725 USD.
006 086 101270	BAT-1270 12V / 7AH. KURU TİP AKÜ	1	ad.	35.875 USD.
YANGIN İHBAR DEDEKTÖRLERİ				
006 086 200001	EOD OPTİK DUMAN DEDEKTÖRÜ	1	ad.	19.475 USD.
006 086 200005	EHD-58 SABİT SICAKLIK DEDEKTÖRÜ-58 C	1	ad.	12.300 USD.
006 086 200006	EHD-82 SABİT SICAKLIK DEDEKTÖRÜ-82 C	1	ad.	12.300 USD.
006 086 200002	ERD SICAKLIK ARTIŞ HIZI DEDEKTÖRÜ	1	ad.	12.300 USD.
006 086 200003	EDB STANDART DEDEKTÖR SÖKETİ	1	ad.	3.075 USD.
YANGIN İHBAR BUTONLARI				
006 086 300001	EYİB.YNG.İHB.BUT. VE KASASI 12-24V	1	ad.	12.300 USD.
YANGIN İHBAR SİRENLERİ VE AKSESUARLARI				
006 086 401224	AS-1224 ELEKTRONİK SİREN, 12-24V	1	ad.	13.325 USD.
006 086 400220	AS-220 ELEKTRONİK SİREN, 220V	1	ad.	15.375 USD.
006 086 500009	ASF-1224 FLAŞÖRLÜ ELEKTRONİK SİR.12-24V	1	ad.	27.675 USD.
006 086 500004	PİL PARALEL İHBAR LAMBASI	1	ad.	10.250 USD.
JUNIOR SER. ANALOG ADR.YNG. ALGİL. VE UY. PAN.KÜÇÜK KASA				
006 086 010001	JNR-VA-1 LOOP YANGIN ALARM KOTROL PANELİ-125 ADRES	1	ad.	871.250 EUR.
006 086 010002	JNR-V4-2 LOOP YANGIN ALARM KOTROL PANELİ-250 ADRES	1	ad.	1.230.000 EUR.
NET SER. ANALOG ADR.YNG. ALGİL. VE UY. PAN.ORTA KASA				
006 086 020125	J-NET-SC-001 LOOP YANGIN AL.KONTROL PANELİ-125 ADRES	1	ad.	1.435.000 EUR.
006 086 020250	J-NET-SC-002 LOOP YANGIN AL.KONTROL PANELİ-250 ADRES	1	ad.	1.678.950 EUR.
006 086 020375	J-NET-SC-003 LOOP YANGIN AL.KONTROL PANELİ-375 ADRES	1	ad.	1.937.250 EUR.
006 086 020400	J-NET-SC-004 LOOP YANGIN AL.KONTROL PANELİ-400 ADRES	1	ad.	2.470.250 EUR.
TEKRARLAMA PANELLERİ (REPEATER)				
006 086 020001	JUNIOR-MINI-REP TEKRARLAMA (REPEATER) PANELİ	1	ad.	638.575 EUR.
NET SER.ANALOG.ADR.YANGIN ALG.VE UYARI PAN.GENİŞ KASA				
006 086 030500	J-NET-SC-004L LOOP YANGIN AL.KONTROL PAN.-500 ADRES	1	ad.	2.662.000 EUR.
006 086 030625	J-NET-SC-005 LOOP YANGIN AL.KONTROL PAN.-625 ADRES	1	ad.	3.267.000 EUR.
006 086 030750	J-NET-SC-006 LOOP YANGIN AL.KONTROL PAN.-750 ADRES	1	ad.	3.518.000 EUR.
006 086 030875	J-NET-SC-007 LOOP YANGIN AL.KONTROL PAN.-875 ADRES	1	ad.	3.856.000 EUR.
006 086 031000	J-NET-SC-008 LOOP YANGIN AL.KONTROL PAN.-1000 ADRES	1	ad.	4.109.000 EUR.
006 086 031125	J-NET-SC-009 LOOP YANGIN AL.KONTROL PAN.-1125 ADRES	1	ad.	4.634.000 EUR.
006 086 031250	J-NET-SC-010 LOOP YANGIN AL.KONTROL PAN.-1250 ADRES	1	ad.	4.972.000 EUR.
006 086 031750	J-NET-SC-011 LOOP YANGIN AL.KONTROL PAN.-1375 ADRES	1	ad.	5.571.000 EUR.
006 086 031500	J-NET-SC-012 LOOP YANGIN AL.KONTROL PAN.-1500 ADRES	1	ad.	5.750.000 EUR.
006 086 031625	J-NET-SC-013 LOOP YANGIN AL.KONTROL PAN.-1625 ADRES	1	ad.	6.089.000 EUR.

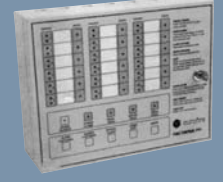



Ürün Kodu	Açıklama / Stok Cinsi	Ambalaj (Kutulu)	Ambalaj Birimi	TL
ANALOG & INTELLIGNET ADRESLİ DEDEKTÖRLER				
006 086 050001	GFE-AD-S ADRESLİ OPTİK DUMAN DEDEKTÖRÜ	1	ad.	32.800 EUR.
006 086 050002	GFE-AD-H ADRESLİ ISI VE ISI ARTIŞ DEDEKTÖRÜ	1	ad.	32.800 EUR.
006 086 050003	GFE-AD-SH ADRESLİ OPTİK+ISI+ISI ARTIŞ HIZI DEDEKTÖRÜ	1	ad.	36.900 EUR.
006 086 050004	GFE-AD-S-LED ADRESLİ OPTİK DUMAN DEDEKTÖRÜ	1	ad.	34.850 EUR.
006 086 050005	GFE-AD-H-LED ADRESLİ ISI VE ISI ARTIŞ HIZI DEDEKTÖRÜ	1	ad.	34.850 EUR.
006 086 050006	GFE-AD-SH-LED ADRESLİ OPTİK+ISI+ISI ARTIŞ HIZI DEDEKTÖRÜ	1	ad.	38.950 EUR.
006 086 050007	GFE-3500 ADRESLİ DEDEKTÖR SOKETİ	1	ad.	3.075 EUR.
ADRESLEME MODÜLLERİ				
006 086 200014	I/O GİRİŞ/ÇIKIŞ MODÜLÜ (ROLE MODÜLÜ)	1	ad.	49.200 EUR.
ANALOG & INTELLIGNET ADRESLİ BUTONLAR-GLOBAL				
006 086 060001	GFE-MCPA ADRESLİ YANGIN İHB.BUTONU VE KASASI	1	ad.	30.750 EUR.
ANALOG & INTELLIGNET ADRESLİ BUTONLAR VE SİRENLER-GLOBAL				
006 086 070001	VULCAN WSA ADRESLİ ELEKTRONİK SİREN	1	ad.	33.825 EUR.
ÖZEL AMAÇLI DEDEKTÖRLER				
006 086 700004	NB-138R-12VDC SU BASKINI DEDEKTÖRÜ RÖLE ÇIKIŞ DC12V	1	ad.	22.550 EUR.
006 086 700005	NB-707A-C-OL SİGARA DUMANI ALGILAMA DED.PİL DAHİL	1	ad.	62.525 EUR.
0,6-1 KV NYY-NYCY KABLOLAR İÇİN REÇİNELİ EK MUFLAR				
052 125 010021	E1 415-E1 425 (4X1,5-4X2,5)	1	ad.	18.343
052 125 010019	E1 404-E1 404 (4X4-4X4)	1	ad.	18.343
052 125 010020	E1 410 (4X10)	1	ad.	28.463
052 125 010022	E1 416 (4X16)	1	ad.	29.095
052 125 010003	E1 115-E1 104 (3X1,5-1X4)	1	ad.	16.698
052 125 010001	E1 106 (1X6)	1	ad.	16.698
052 125 010002	E1 110 (1X10)	1	ad.	19.734
052 125 010004	E1 116-E1 125 (1X16-1X25)	1	ad.	19.734
052 125 010005	E1 135-E1 150 (1X35-1X50)	1	ad.	21.252
052 125 010006	E1 170-E1 195 (1X70-1X95)	1	ad.	22.770
052 125 010024	E1 1120-E1 1150 (1X120-1X150)	1	ad.	30.360
052 125 010025	E1 1185 (1X185)	1	ad.	37.950
052 125 010026	E1 1240 (1X240)	1	ad.	39.215
052 125 010033	E1 31610 (3X16+10)	1	ad.	28.842
052 125 010034	E1 32616 (3X25+16)	1	ad.	30.360
052 125 010035	E1 33516 (3X35+16)	1	ad.	31.878
052 125 010036	E1 35025 (3X50+25)	1	ad.	33.143
052 125 010037	E1 37035 (3X70+35)	1	ad.	53.130
052 125 010038	E1 39550 (3X95+50)	1	ad.	55.660
052 125 010039	E1 31207 (3X120+70)	1	ad.	88.550
052 125 010040	E1 31507 (3X150+70)	1	ad.	92.661
052 125 010041	E1 31859 (3X185+95)	1	ad.	136.620
052 125 010042	E1 32401 (3X240+120)	1	ad.	142.945
052 125 010009	E1 215-E1 204 (2X1,5-2X4)	1	ad.	17.014
052 125 010007	E1 206 (2X6)	1	ad.	17.014
052 125 010008	E1 210 (2X10)	1	ad.	19.355
052 125 010010	E1 216-E1 225 (2X16-2X25)	1	ad.	27.198
052 125 010011	E1 235-E1 250 (2X35-2X50)	1	ad.	30.360
052 125 010012	E1 270-E1 295 (2X70-2X95)	1	ad.	40.986
052 125 010027	E1 2120-E1 2150 (2X120-2X150)	1	ad.	72.738
052 125 010028	E1 2185 (2X185)	1	ad.	126.500
052 125 010029	E1 2240 (2X240)	1	ad.	127.765
052 125 010015	E1 315-E1 304 (3X1,5-3X4)	1	ad.	17.710
052 125 010013	E1 306 (3X6)	1	ad.	17.710
052 125 010014	E1 310 (3X10)	1	ad.	27.324
052 125 010016	E1 316-E1 325 (3X16-3X25)	1	ad.	28.842
052 125 010017	E1 335-E1 350 (3X35-3X50)	1	ad.	31.309
052 125 010018	E1 370-E1 395 (3X70-3X95)	1	ad.	55.028
052 125 010030	E1 3120-E1 3150 (3X120-3X150)	1	ad.	91.080
052 125 010031	E1 3158 (3X185)	1	ad.	135.355
052 125 010032	E1 3240 (3X240)	1	ad.	141.680

Ürün Kodu	Açıklama / Stok Cinsi	Ambalaj (Kutulu)	Ambalaj Birimi	TL
0.6-1 kV ISI BÜZÜŞMELİ EK MUFLARI				
052 125 020012	S1 415-S1 425 (4X1,5-4X2,5) ISI BÜZÜŞMELİ	1	ad.	10.057
052 125 020011	S1 404-S1 406 (4X4-4X6) ISI BÜZÜŞMELİ	1	ad.	10.057
052 125 020001	S1 410 (4X10) ISI BÜZÜŞMELİ	1	ad.	12.650
052 125 020001	S1 416 (4X16) ISI BÜZÜŞMELİ	1	ad.	13.346
052 125 020018	S1 115-S1 104 (1X1,5-1X4) ISI BÜZÜŞMELİ	1	ad.	6.705
052 125 020019	S1 106 (1X6) ISI BÜZÜŞMELİ	1	ad.	6.705
052 125 020020	S1 110 (1X10) ISI BÜZÜŞMELİ	1	ad.	6.705
052 125 020021	S1 116-S1 125 (1X16-1X25) ISI BÜZÜŞMELİ	1	ad.	7.590
052 125 020022	S1 135-S1 150 (1X35-1X50) ISI BÜZÜŞMELİ	1	ad.	10.057
052 125 020023	S1 170-S1 195 (1X70-1X95) ISI BÜZÜŞMELİ	1	ad.	13.915
052 125 020024	S1 1120-S1 1150 (1X120-1X150) ISI BÜZÜŞMELİ	1	ad.	16.698
052 125 020025	S1 1185 (1X185) ISI BÜZÜŞMELİ	1	ad.	20.050
052 125 020026	S1 1240 (1X240) ISI BÜZÜŞMELİ	1	ad.	20.050
052 125 020003	S1 31610 (3X16+10) ISI BÜZÜŞMELİ	1	ad.	13.346
052 125 020004	S1 32616 (3X25+16) ISI BÜZÜŞMELİ	1	ad.	20.050
052 125 020005	S1 33516 (3X35+16) ISI BÜZÜŞMELİ	1	ad.	21.695
052 125 020006	S1 35025 (3X50+25) ISI BÜZÜŞMELİ	1	ad.	23.403
052 125 020007	S1 37035 (3X70+35) ISI BÜZÜŞMELİ	1	ad.	35.104
052 125 020008	S1 39550 (3X95+50) ISI BÜZÜŞMELİ	1	ad.	38.330
052 125 020009	S1 31207 (3X120+70) ISI BÜZÜŞMELİ	1	ad.	49.968
052 125 020027	S1 31507 (3X150+70) ISI BÜZÜŞMELİ	1	ad.	58.443
052 125 020010	S1 31859 (3X185+95) ISI BÜZÜŞMELİ	1	ad.	100.568
052 125 020028	S1 32401 (3X240+120) ISI BÜZÜŞMELİ	1	ad.	105.248
052 125 020029	S1 215-S1 204 (2X1,5-2X4) ISI BÜZÜŞMELİ	1	ad.	8.349
052 125 020030	S1 206 (2X6) ISI BÜZÜŞMELİ	1	ad.	8.349
052 125 020031	S1 210 (2X10) ISI BÜZÜŞMELİ	1	ad.	8.349
052 125 020032	S1 216-S1 225 (2X16-2X25) ISI BÜZÜŞMELİ	1	ad.	8.349
052 125 020033	S1 235-S1 250 (2X35-2X50) ISI BÜZÜŞMELİ	1	ad.	20.240
052 125 020034	S1 270-S1 295 (2X70-2X95) ISI BÜZÜŞMELİ	1	ad.	32.890
052 125 020035	S1 2120-S1 2150 (2X120-2X150) ISI BÜZÜŞMELİ	1	ad.	41.745
052 125 020036	S1 2185 (2X185) ISI BÜZÜŞMELİ	1	ad.	50.094
052 125 020037	S1 2240 (2X240) ISI BÜZÜŞMELİ	1	ad.	52.118
052 125 020038	S1 315-S1 304 (3X1,5-3X4) ISI BÜZÜŞMELİ	1	ad.	9.424
052 125 020039	S1 306 (3X6) ISI BÜZÜŞMELİ	1	ad.	9.424
052 125 020040	S1 310 (3X10) ISI BÜZÜŞMELİ	1	ad.	12.018
052 125 020041	S1 316-S1 325 (3X16-3X25) ISI BÜZÜŞMELİ	1	ad.	19.418
052 125 020042	S1 335-S1 350 (3X35-3X50) ISI BÜZÜŞMELİ	1	ad.	22.770
052 125 020043	S1 370-S1 395 (3X70-3X95) ISI BÜZÜŞMELİ	1	ad.	37.950
052 125 020044	S1 3120-S1 3150 (3X120-3X150) ISI BÜZÜŞMELİ	1	ad.	56.609
052 125 020045	S1 3185 (3X185) ISI BÜZÜŞMELİ	1	ad.	98.670
052 125 020046	S1 3240 (3X240) ISI BÜZÜŞMELİ	1	ad.	103.414
0.6-1 kV PAPUÇSUZ REÇİNELİ KABLO BAŞLIKLARI				
052 125 070001	PKB 01 (2X1,5-3X50+25)	1	ad.	6.958
052 125 070002	PKB 02 (3X70+35-3X95+50)	1	ad.	10.753
052 125 070003	PKB 03 (3X120+70-3X150+70)	1	ad.	18.343
PROTOLİN (REÇİNE)				
052 125 030200	PRO 210 GR. PROTOLİN REÇİNE	1	ad.	6.325
052 125 030300	PRO 300 GR. PROTOLİN REÇİNE	1	ad.	7.274
052 125 030500	PRO 500 GR. PROTOLİN REÇİNE	1	ad.	10.373
052 125 030600	PRO 600 GR. PROTOLİN REÇİNE	1	ad.	12.903
052 125 031000	PRO 1000 GR. PROTOLİN REÇİNE	1	ad.	18.659
052 125 031500	PRO 1500 GR. PROTOLİN REÇİNE	1	ad.	28.083
052 125 033000	PRO 3000 GR. PROTOLİN REÇİNE	1	ad.	56.293
052 125 030040	PRO 40 GR. PROTOLİN REÇİNE	1	ad.	65.148
052 125 030020	PRO 20 KĞ. PROTOLİN REÇİNE	1	ad.	335.225
SİNTAŞ SANAYİ TİPİ FİŞ PRİZLER				
019 107 016250	16X25 A.4 KUTUPLU FİŞ-PRİZ	30	ad.	15.206
019 107 016252	16X25 A.4 KUTUPLU PRİZ	45	ad.	9.158
019 107 016251	16X25 A.4 KUTUPLU FİŞ	60	ad.	6.048
019 107 025400	25x40 A.4 KUTUPLU FİŞ-PRİZ	15	ad.	21.082
019 107 025402	25x40 A.4 KUTUPLU PRİZ	25	ad.	12.096
019 107 025401	25x40 A.4 KUTUPLU FİŞ	35	ad.	8.986
019 107 040630	40X63 A.4 KUTUPLU FİŞ-PRİZ	10	ad.	31.968
019 107 040632	40X63 A.4 KUTUPLU PRİZ	15	ad.	18.144
019 107 040631	40X63 A.4 KUTUPLU FİŞ	25	ad.	13.824
019 107 063100	63X100 A.4 KUTUPLU FİŞ-PRİZ	5	ad.	88.128
019 107 063102	63X100 A.4 KUTUPLU PRİZ	10	ad.	51.840
019 107 063101	63X100 A.4 KUTUPLU FİŞ	10	ad.	36.288

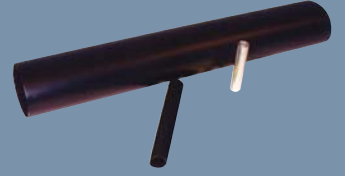

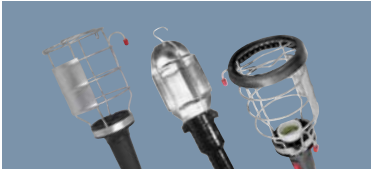

Ürün Kodu	Açıklama / Stok Cinsi	Ambalaj (Kutulu)	Ambalaj Birimi	TL
LİMİT BASINÇ ŞALTERLERİ VE SEVİYE FLATÖRLERİ				
011 095 000500	LM5 (1-6 BAR) MONOFAZE BASINÇ ŞALTERİ	1	ad.	23.040
011 095 000600	LM6 (2-9 BAR) MONOFAZE BASINÇ ŞALTERİ	1	ad.	23.040
011 095 000501	LM6 (2-9 BAR) MONOFAZE BSN. ŞALTERİ THL.	1	ad.	30.960
011 095 000100	LM1 (1-5 BAR) BASINÇ ŞALTERİ TAHLİYESİZ	1	ad.	29.232
011 095 000101	LM1 (1-5 BAR) BASINÇ ŞALTERİ TAHLİYELİ	1	ad.	33.840
011 095 000200	LM2 (2-8 BAR) BASINÇ ŞALTERİ TAHLİYESİZ	1	ad.	29.232
011 095 000201	LM2 (2-8 BAR) BASINÇ ŞALTERİ TAHLİYELİ	1	ad.	33.840
011 095 000300	LM3 (3-11 BAR) BASINÇ ŞALTERİ TAHLİYESİZ	1	ad.	29.232
011 095 000301	LM3 (3-11 BAR) BASINÇ ŞALTERİ TAHLİYELİ	1	ad.	33.840
011 095 000400	LM4 (4-16 BAR) BASINÇ ŞALTERİ TAHLİYESİZ	1	ad.	29.232
011 095 000401	LM4 (4-16 BAR) BASINÇ ŞALTERİ TAHLİYELİ	1	ad.	33.840
011 096 000591	SU SEVİYE FLATÖRÜ (0,6M TTR KABLOLU)	1	ad.	12.672
011 096 000592	SU SEVİYE FLATÖRÜ (1,6M TTR KABLOLU)	1	ad.	17.136
011 096 000593	SU SEVİYE FLATÖRÜ (3M TTR KABLOLU)	1	ad.	19.584
011 096 000590	SU SEVİYE FLATÖRÜ (5M TTR KABLOLU)	1	ad.	23.472
011 096 000594	SU SEVİYE FLATÖRÜ (10M TTR KABLOLU)	1	ad.	34.272
011 096 000595	SU SEVİYE FLATÖRÜ (0,6M KAUÇUK KABLOLU)	1	ad.	14.040
011 096 000596	SU SEVİYE FLATÖRÜ (1,6M KAUÇUK KABLOLU)	1	ad.	19.008
011 096 000597	SU SEVİYE FLATÖRÜ (3M KAUÇUK KABLOLU)	1	ad.	23.760
011 096 000598	SU SEVİYE FLATÖRÜ (5M KAUÇUK KABLOLU)	1	ad.	28.656
011 096 000599	SU SEVİYE FLATÖRÜ (10M KAUÇUK KABLOLU)	1	ad.	44.640
TRİFAZE FİŞ-PRİZ VE ŞALTERLER				
041 116 000002	TRİFAZE PRİZ	12	ad.	5.520
041 116 000001	TRİFAZE FİŞ	20	ad.	5.520
041 118 000201	MONOFAZE ŞALTER (DEMİRBAĞ)	100	ad.	9.221
041 118 000200	TRİFAZE ŞALTER (DEMİRBAĞ)	50	ad.	17.136
DEVRE KESEN VE NH00 KAİDELER				
025 110 000001	TRİFAZE DEVRE KESEN	1	ad.	23.450
025 110 000002	MONOFAZE DEVRE KESEN	2	ad.	12.691
025 110 000003	TEK KOFRE	1	ad.	39.600
025 110 000004	NH00 BOY KAİDE	6	ad.	4.001
025 110 000005	NH00 BOY BIÇAKLI SİG.(25A.-150A.)	10	ad.	4.829
SEYYAR EL LAMBALARI (TEL KAFESLİ)				
005 084 700003	BALADOZ PLASTİK SAPLI (DUYSUZ)	30	ad.	8.640
005 084 700004	BALADOZ KAUÇUK SAPLI (PORS.DUYLU-ANHT.)	20	ad.	28.080
005 084 700006	KOD-80 SEYYAR EL LAMBASI (ANAHTARLI)	20	ad.	18.480
005 084 700007	KOD-81 SEYYAR EL LAMBASI (ANAHTARLI)7MT.	10	ad.	29.400
005 084 700001	KOD-82 SEYYAR EL LAMBASI (ANAHTARSIZ)	8	ad.	16.800
005 084 700002	KOD-83 SEYYAR EL LAMBASI(ANAHTARSIZ)7MT.	8	ad.	27.720
KABLO MAKARALARI (PLASTİK GÖVDE)				
005 083 700045	KOD-45 MONOFAZE PLASTİK BOŞ MAKARA	1	ad.	42.000
005 083 700046	KOD-46 TRİFAZE PLASTİK BOŞ MAKARA	1	ad.	46.200
KABLO MAKARALARI (SAC GÖVDE)				
005 083 700050	KOD-50 MONOFAZE SAC GÖVDE BOŞ MAKARA	1	ad.	50.400
005 083 700052	KOD-52 TRİFAZE SAC GÖVDE BOŞ MAKARA	1	ad.	54.600
ÇANTALI MAKARALAR				
049 122 020012	4 MONO.PRİZ ÇKIŞLI (25 mt.3X1 TSE'Lİ) ÇANTALI MAKARA	1	ad.	93.600
049 122 020013	4 MONO.PRİZ ÇKIŞLI (35 mt.3X1 TSE'Lİ) ÇANTALI MAKARA	1	ad.	111.600
049 122 020014	4 MONO.PRİZ ÇKIŞLI (50 mt.3X1 TSE'Lİ) ÇANTALI MAKARA	1	ad.	139.200
049 122 020015	4 MONO.PRİZ ÇKIŞLI (25 mt.3X1,5 TSE'Lİ) ÇANTALI MAKARA	1	ad.	108.000
049 122 020016	4 MONO.PRİZ ÇKIŞLI (35 mt.3X1,5 TSE'Lİ) ÇANTALI MAKARA	1	ad.	132.000
049 122 020017	4 MONO.PRİZ ÇKIŞLI (50 mt.3X1,5 TSE'Lİ) ÇANTALI MAKARA	1	ad.	165.600
049 122 020018	PLASTİK BOŞ MAKARA	1	ad.	36.00

AIRCOL ASPİRATÖR ÇEŞİTLERİ



Ürün Kodu : 029 088 120100

Ürün Adı : AIRCOL 100 ASPİRATÖR
(OTOMATİK PANJURLU)

Ambalaj Ad. : 1

Fiyat : 57.408



Ürün Kodu : 029 088 110200

Ürün Adı : AIRCOL 200 ASPİRATÖR

Ambalaj Ad. : 1

Fiyat : 66.240



Ürün Kodu : 029 088 110100

Ürün Adı : AIRCOL 100 ASPİRATÖR

Ambalaj Ad. : 1

Fiyat : 34.224



Ürün Kodu : 029 088 130150

Ürün Adı : AIRCOL 150-K ASPİRATÖR
(KAPAKLI MODEL)

Ambalaj Ad. : 1

Fiyat : 55.200



Ürün Kodu : 029 088 110120

Ürün Adı : AIRCOL 120 ASPİRATÖR

Ambalaj Ad. : 1

Fiyat : 38.640



Ürün Kodu : 029 088 130200

Ürün Adı : AIRCOL 200-K ASPİRATÖR
(KAPAKLI MODEL)

Ambalaj Ad. : 1

Fiyat : 60.720



Ürün Kodu : 029 088 110130

Ürün Adı : AIRCOL 130 ASPİRATÖR

Ambalaj Ad. : 1

Fiyat : 30.912



Ürün Kodu : 029 088 140250

Ürün Adı : AIRCOL 250-K ASPİRATÖR
(TAVAN TİPİ)

Ambalaj Ad. : 1

Fiyat : 82.800



Ürün Kodu : 029 088 110150

Ürün Adı : AIRCOL 150 ASPİRATÖR

Ambalaj Ad. : 1

Fiyat : 46.368



Ürün Kodu : 029 088 130020

Ürün Adı : AIRCOL 20-K ASPİRATÖR
(KAPAKLI MODEL)

Ambalaj Ad. : 1

Fiyat : 66.240

AIRCOL ASPİRATÖR ÇEŞİTLERİ



Ürün Kodu : 029 088 130025

Ürün Adı : AIRCOL 25-K ASPİRATÖR
(KAPAKLI MODEL)

Ambalaj Ad. : 1

Fiyat : 77.280



Ürün Kodu : 029 088 130043

Ürün Adı : AIRCOL-100KT KANAL
TİPİ ASPİRATÖR

Ambalaj Ad. : 1

Fiyat : 28.200



Ürün Kodu : 029 088 130030

Ürün Adı : AIRCOL S-300 SANAYİ TİPİ
MONO ASPİRATÖR

Ambalaj Ad. : 1

Fiyat : 138.000



Ürün Kodu : 029 088 130044

Ürün Adı : AIRCOL-120KT KANAL TİPİ
ASPİRATÖR

Ambalaj Ad. : 1

Fiyat : 32.712

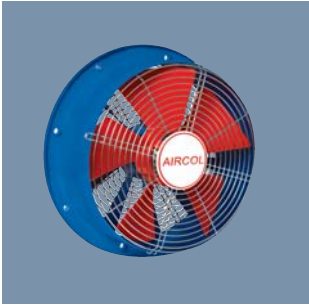

Ürün Kodu : 029 088 130040

Ürün Adı : AIRCOL S-400 SANAYİ TİPİ
MONO ASPİRATÖR

Ambalaj Ad. : 1

Fiyat : 160.080



Ürün Kodu : 029 088 130045

Ürün Adı : AIRCOL-150KT KANAL
TİPİ ASPİRATÖR

Ambalaj Ad. : 1

Fiyat : 39.480



Ürün Kodu : 029 088 130041

Ürün Adı : AIRCOL SPRİNG TAVAN TİPİ
ASPİRATÖR

Ambalaj Ad. : 1

Fiyat : 73.320

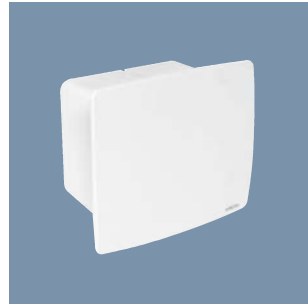

Ürün Kodu : 029 088 130046

Ürün Adı : AIRCOL-LÜX DUVAR VE
TAVAN TİPİ ASPİRATÖR

Ambalaj Ad. : 1

Fiyat : 90.240



Ürün Kodu : 029 088 130042

Ürün Adı : AIRCOL SPRİNG LİGHT
TAVAN TİPİ ASPİRATÖR

Ambalaj Ad. : 1

Fiyat : 84.600

Ürün Kodu	Açıklama / Stok Cinsi	Ambalaj (Kutulu)	Ambalaj Birimi	TL
AC AKSİYEL KAPAKLI ASPİRATÖRLER				
080 088 200160	BK160MM KAPAKLI ASPİRATÖR (40WATT 1200 DEV/DAK)	1	ad.	81.408
080 088 200200	BK200MM KAPAKLI ASPİRATÖR (40WAT 1200 DEV/DAK)	1	ad.	95.400
080 088 200250	BK250MM KAPAKLI ASPİRATÖR (50WAT 1100 DEV/DAK)	1	ad.	110.664
080 088 200300	BK300MM KAPAKLI ASPİRATÖR (60WAT 1050 DEV/DAK)	1	ad.	139.920

AC AKSİYEL BACA ASPİRATÖRLER				
080 088 160160	BB160MM BACA ASPİRATÖR (40WATT 1200 DEV/DAK)	1	ad.	78.864
080 088 160200	BB200MM BACA ASPİRATÖR (40WAT 1200 DEV/DAK)	1	ad.	89.040
080 088 160250	BB250MM BACA ASPİRATÖR (50WAT 1100 DEV/DAK)	1	ad.	101.760
080 088 160300	BB300MM BACA ASPİRATÖR (60WAT 1050 DEV/DAK)	1	ad.	127.200

MONOFAZE SANAYİ TİPİ ASPİRATÖRLER				
080 088 002250	BSM250-2K MONOFAZE SANAYİ ASP.(180W 2900 DEV/DAK)	1	ad.	228.960
080 088 000250	BSM250 MONOFAZE SANAYİ ASP.(160W 1480 DEV/DAK)	1	ad.	190.800
080 088 000300	BSM300 MONOFAZE SANAYİ ASP.(180W 1400 DEV/DAK)	1	ad.	203.520
080 088 000350	BSM350 MONOFAZE SANAYİ ASP.(200W 1450 DEV/DAK)	1	ad.	216.240
080 088 000400	BSM400 MONOFAZE SANAYİ ASP.(220W 1450 DEV/DAK)	1	ad.	241.680
080 088 000450	BSM450 MONOFAZE SANAYİ ASP.(240W 1400 DEV/DAK)	1	ad.	254.400
080 088 000500	BSM500 MONOFAZE SANAYİ ASP.(280W 1400 DEV/DAK)	1	ad.	279.840
080 088 000550	BSM550 MONOFAZE SANAYİ ASP.(290W 1400 DEV/DAK)	1	ad.	356.160
080 088 000600	BSM600 MONOFAZE SANAYİ ASP.(310W 1400 DEV/DAK)	1	ad.	356.160

TRİFAZE SANAYİ TİPİ ASPİRATÖRLER				
080 088 102250	BST250-2K TRİFAZE SANAYİ ASP.(180W 2800 DEV/DAK)	1	ad.	228.960
080 088 100250	BST250 TRİFAZE SANAYİ ASP.(100W 1400 DEV/DAK)	1	ad.	190.800
080 088 100300	BST300 TRİFAZE SANAYİ ASP.(125W 1400 DEV/DAK)	1	ad.	203.520
080 088 100350	BST350 TRİFAZE SANAYİ ASP.(175W 1400 DEV/DAK)	1	ad.	216.240
080 088 100400	BST400 TRİFAZE SANAYİ ASP.(170W 1400 DEV/DAK)	1	ad.	241.680
080 088 100450	BST450 TRİFAZE SANAYİ ASP.(210W 1400 DEV/DAK)	1	ad.	254.400
080 088 100500	BST500 TRİFAZE SANAYİ ASP.(230W 1400 DEV/DAK)	1	ad.	279.840
080 088 100550	BST550 TRİFAZE SANAYİ ASP.(220W 1400 DEV/DAK)	1	ad.	356.160
080 088 100600	BST600 TRİFAZE SANAYİ ASP.(200W 1400 DEV/DAK)	1	ad.	356.160

AC RADYAL FANLAR (SAC GÖVDELİ)				
080 088 012550	BDRS 125-50 AC RADYAL FAN (97W 2450 DEV/DAK)	1	ad.	159.000
080 088 012060	BDRS 120-60 AC RADYAL FAN (90W 2400 DEV/DAK)	1	ad.	165.360
080 088 014060	BDRS 140-60 AC RADYAL FAN (160W 2300 DEV/DAK)	1	ad.	190.800
080 088 016060	BDRS 160-60 AC RADYAL FAN (225W 2200 DEV/DAK)	1	ad.	216.240

AC TEK GİRİŞLİ SALLYANGOZ FANLAR				
080 088 000140	OBR140M-2K SALLYANGOZ FAN (250W 2800 D/D)	1	ad.	228.960
080 088 002200	OBR200M-2K SALLYANGOZ FAN (620W 2800 D/D)	1	ad.	254.400
080 088 002210	OBR200M-2K SALLYANGOZ FAN (600W 2800 D/D) SEYREK KANAT	1	ad.	305.280
080 088 002400	OBR200M-4K SALLYANGOZ FAN (200W 1450 D/D)	1	ad.	254.400
080 088 002220	OBR200T-2K SALLYANGOZ FAN (600W 2800 D/D)	1	ad.	254.400
080 088 002410	OBR200T-4K SALLYANGOZ FAN (130W 1400 D/D)	1	ad.	254.400
080 088 000260	OBR260M-2K SALLYANGOZ FAN (750W 2800 D/D) GAMAK MOTOR.	1	ad.	737.760
080 088 002600	OBR260M-4K SALLYANGOZ FAN (370W 1400 D/D)	1	ad.	356.160
080 088 002610	OBR260T-2K SALLYANGOZ FAN (750W 2800 D/D) GAMAK MOTOR	1	ad.	636.000
080 088 002620	OBR260T-4K SALLYANGOZ FAN (370W 1400 D/D)	1	ad.	356.160

3 KANATLI KLASİK VE 4 KANATLI LÜKS VANTİLATÖRLER				
080 088 100001	KAV (KLASİK AYAKLI) VANTİLATÖR (190W 1450 D/D)	1	ad.	407.040
080 088 100002	KDTV (KLASİK DUVAR TİPİ) VANTİLATÖR (190W 1450 D/D)	1	ad.	407.040
080 088 100003	LAV (LÜX AYAKLI) VANTİLATÖR (180W 1450 D/D)	1	ad.	457.920
080 088 100004	LYV (LÜX YÜRÜYEN) VANTİLATÖR (180W 1450 D/D)	1	ad.	457.920
080 088 100005	LDTV (LÜX DUVAR TİPİ) VANTİLATÖR (180W 1450 D/D)	1	ad.	407.040
080 088 100006	LYTV (LÜX YER TİPİ) VANTİLATÖR (180W 1450 D/D)	1	ad.	407.040

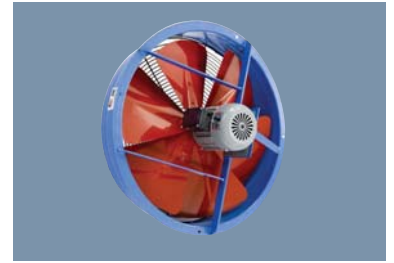



AYDINLATMA

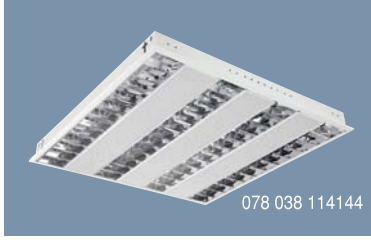

Ürün Kodu	Açıklama / Stok Cinsi	Ambalaj (Kutulu)	Ambalaj Birimi	TL
RELUX REFLEKTÖRLÜ SIVA ALTI TL5 LAMBALI ARMATÜRLER				
078 038 114144	011414-4 4x14 W RELUX REFLEKTÖRLÜ 4 AYRI S/A	1	ad.	150.900
078 038 114143	011414-3 4x14 W RELUX REFLEKTÖRLÜ 2 AYRI S/A	1	ad.	154.385
078 038 114142	011414-2 4x14 W RELUX REFLEKTÖRLÜ ORTA S/A	1	ad.	161.406
078 038 011314	011314 3x14 W RELUX REFLEKTÖRLÜ S/A	1	ad.	150.900
078 038 011228	011228 2x28 W RELUX REFLEKTÖRLÜ S/A	1	ad.	154.385
078 038 011214	011214 2x14 W RELUX REFLEKTÖRLÜ S/A	1	ad.	136.869

RELUXOPTİMA PRİZMATİK LENSLİ SIVA ALTI TL5 ARMATÜRLER				
078 038 012414	012414 4x14 W RELUXOPTİMA PRİZMATİK S/A	1	ad.	147.397
078 038 012214	012214 2x14 W RELUXOPTİMA PRİZMATİK S/A	1	ad.	133.359
078 038 012228	012228 2x28 W RELUXOPTİMA PRİZMATİK S/A	1	ad.	150.907

RELUXOPTİMA OPAL LENSLİ SIVA ALTI TL5 ARMATÜRLER				
078 038 014414	014414 4x14 W RELUXOPTİMA OPAL S/A	1	ad.	150.907
078 038 014214	014214 2x14 W RELUXOPTİMA OPAL S/A	1	ad.	136.869
078 038 014228	014228 2x28 W RELUXOPTİMA OPAL S/A	1	ad.	154.416

RELUXOPTİMA VEGA LENSLİ SIVA ALTI TL5 ARMATÜRLER				
078 038 017414	017414 4x14 W RELUXOPTİMA VEGA S/A	1	ad.	157.926
078 038 017214	017214 2x14 W RELUXOPTİMA VEGA S/A	1	ad.	143.888
078 038 017228	017228 2x28 W RELUXOPTİMA VEGA S/A	1	ad.	161.406

RELUXDECORA REFLEKTÖRLÜ SIVA ÜSTÜ TL5 LAMBALI ARMATÜRLER				
078 038 214144	021414-4 4x14 W RELUXDECORA REFLEKTÖRLÜ 4 AYRI S/Ü	1	ad.	150.907
078 038 214143	021414-3 4x14 W RELUXDECORA REFLEKTÖRLÜ 2 AYRI S/Ü	1	ad.	154.385
078 038 214142	021414-2 4x14 W RELUXDECORA REFLEKTÖRLÜ ORTA S/Ü	1	ad.	161.435
078 038 021314	021314 3x14 W RELUXDECORA REFLEKTÖRLÜ S/Ü	1	ad.	150.907
078 038 021214	021214 2x14 W RELUXDECORA REFLEKTÖRLÜ S/Ü	1	ad.	136.869
078 038 021228	021228 2x28 W RELUXDECORA REFLEKTÖRLÜ S/Ü	1	ad.	154.416
078 038 213228	021328 2x28 W DECORA OFIS LAMP S/Ü	1	ad.	182.492

DECORA RELUXOPTİMA PRİZMATİK LENSLİ SIVA ÜSTÜ TL5 / T 8 LAMBALI ARMATÜRLER				
078 038 222414	0222414 4x14 W DECORA RELUXOPTİMA PRİZMATİK S/Ü	2	ad.	147.397
078 038 222214	0222214 2x14 W DECORA RELUXOPTİMA PRİZMATİK S/Ü	2	ad.	133.359
078 038 222228	0222228 2x28 W DECORA RELUXOPTİMA PRİZMATİK S/Ü	2	ad.	150.907
078 038 222418	0222418 4x18 W DECORA RELUXOPTİMA PRİZMATİK S/Ü	2	ad.	78.612
078 038 222218	0222218 2x18 W DECORA RELUXOPTİMA PRİZMATİK S/Ü	2	ad.	56.853
078 038 222236	0222236 2x36 W DECORA RELUXOPTİMA PRİZMATİK S/Ü	2	ad.	81.419
078 038 222436	0222436 4x36 W DECORA RELUXOPTİMA PRİZMATİK S/Ü	2	ad.	171.963

DECORA RELUXOPTİMA OPAL LENSLİ SIVA ÜSTÜ TL5 / T8 LAMBALI ARMATÜRLER				
078 038 242414	0242414 4x14 W DECORA RELUXOPTİMA OPAL S/Ü	2	ad.	150.907
078 038 242214	0242214 2x14 W DECORA RELUXOPTİMA OPAL S/Ü	2	ad.	136.869
078 038 242228	0242228 2x28 W DECORA RELUXOPTİMA OPAL S/Ü	2	ad.	154.416
078 038 242418	0242418 4x18 W DECORA RELUXOPTİMA OPAL S/Ü	2	ad.	90.544
078 038 242218	0242218 2x18 W DECORA RELUXOPTİMA OPAL S/Ü	2	ad.	64.223
078 038 242236	0242236 2x36 W DECORA RELUXOPTİMA OPAL S/Ü	2	ad.	92.284
078 038 242436	0242436 4x36 W DECORA RELUXOPTİMA OPAL S/Ü	2	ad.	191.616

DECORA RELUXOPTİMA VEGA LENSLİ SIVA ÜSTÜ TL5 / T8 LAMBALI ARMATÜRLER				
078 038 272414	0272414 4x14 W DECORA RELUXOPTİMA VEGA S/Ü	2	ad.	157.926
078 038 272214	0272214 2x14 W DECORA RELUXOPTİMA VEGA S/Ü	2	ad.	143.888
078 038 272228	0272228 2x28 W DECORA RELUXOPTİMA VEGA S/Ü	2	ad.	161.435
078 038 272418	0272418 4x18 W DECORA RELUXOPTİMA VEGA S/Ü	2	ad.	108.091
078 038 272218	0272218 2x18 W DECORA RELUXOPTİMA VEGA S/Ü	2	ad.	78.612
078 038 272236	0272236 2x36 W DECORA RELUXOPTİMA VEGA S/Ü	2	ad.	111.630
078 038 272436	0272436 4x36 W DECORA RELUXOPTİMA VEGA S/Ü	2	ad.	216.183

DECORA RELUXOPTİMA LOUVER PETEKLİ ARMATÜRLER				
078 038 232414	0232414 4x14 W DECORA RELUXOPTİMA LOUVER S/Ü	2	ad.	168.454
078 038 232214	0232214 2x14 W DECORA RELUXOPTİMA LOUVER S/Ü	2	ad.	154.416
078 038 232228	0232228 2x28 W DECORA RELUXOPTİMA LOUVER S/Ü	2	ad.	168.454
078 038 232418	0232418 4x18 W DECORA RELUXOPTİMA LOUVER S/Ü	2	ad.	126.341
078 038 232218	0232218 2x18 W DECORA RELUXOPTİMA LOUVER S/Ü	2	ad.	89.519
078 038 232236	0232236 2x36 W DECORA RELUXOPTİMA LOUVER S/Ü	2	ad.	125.639
078 038 232436	0232436 4x36 W DECORA RELUXOPTİMA LOUVER S/Ü	2	ad.	258.968

Ürün Kodu	Açıklama / Stok Cinsi	Ambalaj (Kutulu)	Ambalaj Birimi	TL
BASİC ÇİFT PARABOLİK SIVA ALTI T8 LAMBALI ARMATÜRLER				
078 038 114181	011418-1 4x18 W BASİC ÇİFT PARABOLİK 9 LAMEL S/A	2	ad.	67.733
078 038 011418	011418 4x18 W BASİC ÇİFT PARABOLİK S/A	2	ad.	61.416
078 038 011218	011218 2x18 W BASİC ÇİFT PARABOLİK S/A	2	ad.	45.309
078 038 011236	011236 2x36 W BASİC ÇİFT PARABOLİK S/A	2	ad.	63.872
078 038 011436	011436 4x36 W BASİC ÇİFT PARABOLİK S/A	2	ad.	129.885
BASİC OPTİMA PRİZMATİK LENSLİ SIVA ALTI T8 LAMBALI ARMATÜRLER				
078 038 012218	012218 2x18 W BASİC OPTİMA PRİZMATİK S/A	2	ad.	55.449
078 038 012418	012418 4x18 W BASİC OPTİMA PRİZMATİK S/A	2	ad.	75.102
078 038 012236	012236 2x36 W BASİC OPTİMA PRİZMATİK S/A	2	ad.	78.612
078 038 012436	012436 4x36 W BASİC OPTİMA PRİZMATİK S/A	2	ad.	165.984
BASİC OPTİMA OPAL LENSLİ SIVA ALTI T8 LAMBALI ARMATÜRLER				
078 038 014218	014218 2x18 W BASİC OPTİMA OPAL S/A	2	ad.	62.819
078 038 014418	014418 4x18 W BASİC OPTİMA OPAL S/A	2	ad.	87.736
078 038 014236	014236 2x36 W BASİC OPTİMA OPAL S/A	2	ad.	89.491
078 038 014436	014436 4x36 W BASİC OPTİMA OPAL S/A	2	ad.	186.001
BASİC OPTİMA VEGA LENSLİ SIVA ALTI T8 LAMBALI ARMATÜRLER				
078 038 017218	017218 2x18 W BASİC OPTİMA VEGA S/A	2	ad.	77.208
078 038 017418	017418 4x18 W BASİC OPTİMA VEGA S/A	2	ad.	105.284
078 038 017236	017236 2x36 W BASİC OPTİMA VEGA S/A	2	ad.	108.793
078 038 017436	017436 4x36 W BASİC OPTİMA VEGA S/A	2	ad.	210.568
BASİC OPTİMA LOUVER PETEK SIVA ALTI T8 LAMBALI ARMATÜRLER				
078 038 013218	013218 2x18 W BASİC OPTİMA LOUVER S/A	2	ad.	87.736
078 038 013418	013418 4x18 W BASİC OPTİMA LOUVER S/A	2	ad.	122.831
078 038 013236	013236 2x36 W BASİC OPTİMA LOUVER S/A	2	ad.	122.831
078 038 013436	013436 4x36 W BASİC OPTİMA LOUVER S/A	2	ad.	256.190
CLASİC ÇİFT PARABOLİK SIVA ÜSTÜ T8 LAMBALI ARMATÜRLER				
078 038 021418	021418 4x18 W ÇİFT PARABOLİK S/Ü	2	ad.	64.223
078 038 021218	021218 2x18 W ÇİFT PARABOLİK S/Ü	2	ad.	46.676
078 038 021236	021236 2x36 W ÇİFT PARABOLİK S/Ü	2	ad.	66.680
078 038 021436	021436 4x36 W ÇİFT PARABOLİK S/Ü	2	ad.	135.465
CLASİC OPTİMA PRİZMATİK LENSLİ SIVA ÜSTÜ T8 LAMBALI ARMATÜRLER				
078 038 022218	022218 2x18 W CLASİC OPTİMA PRİZMATİK S/Ü	2	ad.	56.853
078 038 022418	022418 4x18 W CLASİC OPTİMA PRİZMATİK S/Ü	2	ad.	78.612
078 038 022236	022236 2x36 W CLASİC OPTİMA PRİZMATİK S/Ü	2	ad.	81.419
078 038 022436	022436 4x36 W CLASİC OPTİMA PRİZMATİK S/Ü	2	ad.	171.613
CLASİC OPTİMA OPAL LENSLİ SIVA ÜSTÜ T8 LAMBALI ARMATÜRLER				
078 038 024218	024218 2x18 W CLASİC OPTİMA OPAL S/Ü	2	ad.	64.223
078 038 024418	024418 4x18 W CLASİC OPTİMA OPAL S/Ü	2	ad.	90.544
078 038 024236	024236 2x36 W CLASİC OPTİMA OPAL S/Ü	2	ad.	92.299
078 038 024436	024436 4x36 W CLASİC OPTİMA OPAL S/Ü	2	ad.	175.473
CLASİC OPTİMA VEGA LENSLİ SIVA ÜSTÜ T8 LAMBALI ARMATÜRLER				
078 038 027218	027218 2x18 W CLASİC OPTİMA VEGA S/Ü	2	ad.	78.612
078 038 027418	027418 4x18 W CLASİC OPTİMA VEGA S/Ü	2	ad.	108.091
078 038 027236	027236 2x36 W CLASİC OPTİMA VEGA S/Ü	2	ad.	111.601
078 038 027346	027436 4x36 W CLASİC OPTİMA VEGA S/Ü	2	ad.	216.183
CLASİC OPTİMA LOUVER PETEK SIVA ÜSTÜ T8 LAMBALI ARMATÜRLER				
078 038 023218	023218 2x18 W CLASİC OPTİMA LOUVER S/Ü	2	ad.	89.140
078 038 023418	023418 4x18 W CLASİC OPTİMA LOUVER S/Ü	2	ad.	125.639
078 038 023236	023236 2x36 W CLASİC OPTİMA LOUVER S/Ü	2	ad.	125.639
078 038 023436	023436 4x36 W CLASİC OPTİMA LOUVER S/Ü	2	ad.	258.998
DECORA ÇİFT PARABOLİK SIVA ÜSTÜ T8 LAMBALI ARMATÜRLER				
078 038 212418	0212418 4x18 W DECORA ÇİFT PARABOLİK S/Ü	2	ad.	64.223
078 038 212218	0212218 2x18 W DECORA ÇİFT PARABOLİK S/Ü	2	ad.	46.676
078 038 212236	0212236 2x36 W DECORA ÇİFT PARABOLİK S/Ü	2	ad.	66.680
078 038 212436	0212436 4x36 W DECORA ÇİFT PARABOLİK S/Ü	2	ad.	135.465





Ürün Kodu	Açıklama / Stok Cinsi	Ambalaj (Kutulu)	Ambalaj Birimi	TL
DECORA TURBO SIVA ÜSTÜ T8 LAMBALI ARMATÜRLER				
078 038 214218	0214218 2x18 W DECORA TURBO S/Ü	1	ad.	67.733
078 038 214418	0214418 4x18 W DECORA TURBO S/Ü	1	ad.	90.895
078 038 214236	0214236 2x36 W DECORA TURBO S/Ü	1	ad.	92.686
078 038 214436	0214436 4x36 W DECORA TURBO S/Ü	1	ad.	196.530
DECORA TURBO SIVA ALTI T8 LAMBALI ARMATÜRLER				
078 038 114218	0114218 2x18 W DECORA TURBO S/A	2	ad.	67.733
078 038 114418	0114418 4x18 W DECORA TURBO S/A	2	ad.	90.873
078 038 114236	0114236 2x36 W DECORA TURBO S/A	2	ad.	92.650
078 038 114436	0114436 4x36 W DECORA TURBO S/A	2	ad.	196.530
MİDİ KOMPAKT FLUORESCENT ARMATÜRLER				
078 038 219218	0219218 2x18 W MİDİ ÇİFT PARABOLİK SIVA ÜSTÜ	1	ad.	49.483
078 038 229218	0229218 2x18 W MİDİ PRİZMATİK LENSLİ SIVA ÜSTÜ	1	ad.	59.310
078 038 119218	0119218 2x18 W MİDİ ÇİFT PARABOLİK SIVA ALTI	1	ad.	46.714
078 038 129218	0129218 2x18 W MİDİ PRİZMATİK LENSLİ SIVA ALTI	1	ad.	56.447
MİDİ KOMPAKT FLUORESCENT ARMATÜRLER				
078 038 219211	0219211 2x11 W MİDİ ÇİFT PARABOLİK SIVA ÜSTÜ	1	ad.	43.42
078 038 229211	0229211 2x11 W MİDİ PRİZMATİK LENSLİ SIVA ÜSTÜ	1	ad.	52.01
078 038 119211	0119211 2x11 W MİDİ ÇİFT PARABOLİK SIVA ALTI	1	ad.	41.06
078 038 129211	0129211 2x11 W MİDİ PRİZMATİK LENSLİ SIVA ALTI	1	ad.	49.66
FLORA DİREKT-ENDİREK SIVA ALTI ARMATÜRLER				
078 038 183155	0183155 1x55 W FLORA DİREKT -ENDİREK S/A	1	ad.	189.511
078 038 183255	0183255 2x55 W FLORA DİREKT -ENDİREK S/A	1	ad.	193.020
078 038 183214	0183214 2x14 W FLORA DİREKT -ENDİREK S/A	1	ad.	189.511
078 038 183314	0183314 3x14 W FLORA DİREKT -ENDİREK S/A	1	ad.	193.020
FLORA ORTADAN PERFORE ENDİREK SIVA ALTI ARMATÜR				
078 038 181236	0181236 2x36 W FLORA MEKANİK BALASTLI S/A	1	ad.	133.332
078 038 181255	0181255 2x55 W FLORA ELEKTRONİK BALASTLI S/A	1	ad.	161.435
078 038 181218	0181218 2x18 W FLORA MEKANİK BALASTLI S/A	1	ad.	133.359
078 038 181214	0181214 2x14 W FLORA ELEKTRONİK BALASTLI S/A	1	ad.	164.435
FLORA ENDİREK ASİMETRİK SIVA ALTI ARMATÜRLER				
078 038 016136	016136 1x36 W FLORA ASİMETRİK S/A	2	ad.	94.755
078 038 016155	016155 1x55 W FLORA ASİMETRİK S/A	2	ad.	133.359
FLORA ORTADAN PERFORE ENDİREK SIVA ÜSTÜ ARMATÜR				
078 038 0281236	0281236 2x36 W FLORA MEKANİK BALASTLI S/Ü	1	ad.	119.322
078 038 0281255	0281255 2x36 W FLORA ELEKTRONİK BALASTLI S/Ü	1	ad.	147.397
LAMEL TAVAN SIVA ALTI ARMATÜRLER				
078 038 911118	911118 1x18 W LAMEL S/A	1	ad.	30.883
078 038 911136	911136 1x36 W LAMEL S/A	1	ad.	47.027
078 038 911158	911158 1x58 W LAMEL S/A	1	ad.	66.680
LAMEL TAVAN SIVA ALTI ÇİFT PARABOLİK ARMATÜRLER				
078 038 111361	911136-1 1x36 W LAMEL ÇİFT PARABOLİK S/A	1	ad.	56.151
078 038 911236	911236 2x36 W LAMEL ÇİFT PARABOLİK S/A	1	ad.	61.766
BATTEN TMS BANT TİPİ T8 LAMBALI ARMATÜR				
078 038 900118	900118 1x18 W TMS	6	ad.	16.494
078 038 900136	900136 1x36 W TMS	6	ad.	18.161
078 038 900218	900218 2x18 W TMS	6	ad.	18.179
078 038 900236	900236 2x36 W TMS	6	ad.	29.409
078 038 900158	900158 1x58 W TMS	6	ad.	30.883
078 038 900258	900258 2x58 W TMS	6	ad.	44.570
BATTEN RMS BANT TİPİ T5 LAMBALI ARMATÜRLER				
078 038 900114	900114 1 x 14/24 W RMS	6	ad.	36.000 EUR.
078 038 900214	900214 2 x 14/24 W RMS	6	ad.	41.400 EUR.
078 038 900121	900121 1 x 21/39 W RMS	6	ad.	36.600 EUR.
078 038 900221	900221 2 x 21/39 W RMS	6	ad.	44.040 EUR.
078 038 900128	900128 1 x 28/54 W RMS	6	ad.	37.728 EUR.
078 038 900228	900228 2 x 28/54 W RMS	6	ad.	45.360 EUR.
078 038 900135	900135 1 x 35/80 W RMS	6	ad.	38.400 EUR.
078 038 900235	900235 2 x 35/80 W RMS	6	ad.	45.600 EUR.

Ürün Kodu	Açıklama / Stok Cinsi	Ambalaj (Kutulu)	Ambalaj Birimi	TL
BATTEN TMR BANT TİPİ T8 LAMBALI ARMATÜRLER				
078 038 901118	901118 1x18 W REFLEKTÖRLÜ	6	ad.	26.341
078 038 901136	901136 1x36 W REFLEKTÖRLÜ	6	ad.	34.042
078 038 901218	901218 2x18 W REFLEKTÖRLÜ	6	ad.	29.129
078 038 901236	901236 2x36 W REFLEKTÖRLÜ	6	ad.	44.570
078 038 901158	901158 1x58 W REFLEKTÖRLÜ	6	ad.	62.131
078 038 901258	901258 2x58 W REFLEKTÖRLÜ	6	ad.	95.106

BATTEN EMS ETANJ DUYLU BANT TİPİ T8 LAMBALI ARMATÜRLER				
078 038 905118	905118 1x18 W BATTEN EMS	1	ad.	32.287
078 038 905136	905136 1x36 W BATTEN EMS	1	ad.	42.815
078 038 905218	905218 2x18 W BATTEN EMS	1	ad.	35.796
078 039 905236	905236 2x36 W BATTEN EMS	1	ad.	54.748
078 038 905158	905158 1x58 W BATTEN EMS	1	ad.	52.151
078 038 905258	905258 2x58 W BATTEN EMS	1	ad.	94.404

BATTEN TRS BANT TİPİ REFLEKTÖRLÜ TL5 LAMBALI ARMATÜRLER				
078 038 901114	901114 1 x 14/24 W BATTEN TRS REFLEKTÖRLÜ	2	ad.	44.040 EUR.
078 038 901214	901214 2 x 14/24 W BATTEN TRS REFLEKTÖRLÜ	2	ad.	51.432 EUR.
078 038 901121	901121 1 x 21/39 W BATTEN TRS REFLEKTÖRLÜ	2	ad.	46.800 EUR.
078 038 901221	901221 2 x 21/39 W BATTEN TRS REFLEKTÖRLÜ	2	ad.	53.952 EUR.
078 038 901128	901128 1 x 28/54 W BATTEN TRS REFLEKTÖRLÜ	2	ad.	49.440 EUR.
078 038 901228	901228 2 x 28/54 W BATTEN TRS REFLEKTÖRLÜ	2	ad.	56.760 EUR.
078 038 901135	901135 1 x 35/80 W BATTEN TRS REFLEKTÖRLÜ	2	ad.	51.432 EUR.
078 038 901235	901235 2 x 35/80 W BATTEN TRS REFLEKTÖRLÜ	2	ad.	57.600 EUR.

BATTEN TSC (OKUL TİPİ) OKUL TİPİ T8 LAMBALI ARMATÜRLER				
078 038 050118	050118 1x18 W BATTEN TSC (OKUL TİPİ)	2	ad.	31.585
078 038 050136	050136 1x36 W BATTEN TSC (OKUL TİPİ)	2	ad.	41.412
078 038 050218	050218 2x18 W BATTEN TSC (OKUL TİPİ)	2	ad.	35.095
078 038 050236	050236 2x36 W BATTEN TSC (OKUL TİPİ)	2	ad.	53.905

COSMO ETANJ T8 LAMBALI ARMATÜRLER				
078 038 040118	040118 1x18 W COSMO ETANJ	2	ad.	38.413
078 038 040136	040136 1x36 W COSMO ETANJ	2	ad.	47.500
078 038 040218	040218 2x18 W COSMO ETANJ	2	ad.	41.738
078 038 040236	040236 2x36 W COSMO ETANJ	2	ad.	54.665

COSMO ETANJ SLIM WAVE T5 LAMBALI ARMATÜRLER				
078 038 040114	040114 1x14 /24 W COSMO SLIM Wave Etanj	2	ad.	95.000
078 038 040128	040128 1x28 /54 W COSMO SLIM Wave Etanj	2	ad.	100.000
078 038 040214	040214 2x14 /24 W COSMO SLIM Wave Etanj	2	ad.	103.000
078 038 040228	040228 2x28 /54 W COSMO SLIM Wave Etanj	2	ad.	110.000

CLN STERİL ORTAM TL5 / T8 LAMBALI ARMATÜRLER				
078 038 030414	030414 4 x 14 W CLN STERİL IP 65	1	ad.	249.172
078 038 030418	030418 4 x 18 W CLN STERİL IP 65 S/A	1	ad.	238.643
078 038 031418	031418 4 x 18 W CLN STERİL IP 40	1	ad.	126.341

MİRA ENDÜSTRİYEL ATÖLYE TİPİ SS2 ARMATÜR				
078 038 506125	506125 125 W MİRA CİVA BUHARLI	1	ad.	80.367
078 038 506250	506250 250 W MİRA CİVA BUHARLI	1	ad.	107.853
078 038 506400	506400 400 W MİRA CİVA BUHARLI	1	ad.	123.736
078 038 507150	507150 150 W MİRA SODYUM BUHARLI	1	ad.	127.060
078 038 507250	507250 250 W MİRA SODYUM BUHARLI	1	ad.	143.312
078 038 507400	507400 400 W MİRA SODYUM BUHARLI	1	ad.	161.410
078 038 508001	508001 160 W BOŞ MİRA	1	ad.	60.735

ASTRA ENDÜSTRİYEL ATÖLYE TİPİ HDK ARMATÜR				
078 038 508002	508002 160 BOŞ ASTRA	1	ad.	85.313
078 038 500125	500125 125 W ASTRA CİVA BUHARLI	1	ad.	102.125
078 038 500250	500250 250 W ASTRA CİVA BUHARLI	1	ad.	121.076
078 038 500400	500400 400 W ASTRA CİVA BUHARLI	1	ad.	136.266
078 038 501400	501400 400 W ASTRA SODYUM BUHARLI	1	ad.	172.029
078 038 502150	502150 150 W ASTRA METAL BALASTLI	1	ad.	139.645
078 038 502400	502400 400 W ASTRA METAL BALASTLI	1	ad.	169.536

KOMPAKT VE FLUORESCENT BALASTLAR				
078 038 150010	150010 7-9-11 W KOMPAKT BALAST	36	ad.	6.984
078 038 150011	150011 10-13 W KOMPAKT BALAST	36	ad.	6.984
078 038 150012	150012 18 W KOMPAKT BALAST	36	ad.	6.984
078 038 150013	150013 26 W KOMPAKT BALAST	24	ad.	7.721
078 038 150014	150014 15 W FLUORESCENT BALAST	24	ad.	7.721
078 038 150015	150015 20 W FLUORESCENT BALAST	24	ad.	7.721
078 038 150001	150001 32 W FLUORESCENT BALAST	24	ad.	7.721
078 038 150002	150002 40 W FLUORESCENT BALAST	24	ad.	7.721
078 038 150006	150006 58 W FLUORESCENT BALAST	24	ad.	16.986





078 038 150022



078 038 150035



078 038 150050



078 038 060001



078 038 061001



078 038 062001



Ürün Kodu	Açıklama / Stok Cinsi	Ambalaj (Kutulu)	Ambalaj Birimi	TL
-----------	-----------------------	------------------	----------------	----

YÜKSEK BASINÇLI CİVA BUHARLI BALASTLAR

078 038 150020	150020 50 W CİVA BUHARLI BALAST	4	ad.	21.057
078 038 150021	150021 80 W CİVA BUHARLI BALAST	4	ad.	21.057
078 038 150022	150022 125 W CİVA BUHARLI BALAST	4	ad.	21.057
078 038 150023	150023 250 W CİVA BUHARLI BALAST	4	ad.	35.715
078 038 150024	150024 400 W CİVA BUHARLI BALAST	2	ad.	51.904
078 038 150025	150025 700 W CİVA BUHARLI BALAST	2	ad.	80.742
078 038 150026	150026 1000 W CİVA BUHARLI BALAST	2	ad.	161.485

YÜKSEK BASINÇLI SODYUM BUHARLI BALASTLAR

078 038 150030	150030 35 W SODYUM BUHARLI BALAST	4	ad.	18.530
078 038 150031	150031 50 W SODYUM BUHARLI BALAST	4	ad.	21.077
078 038 150032	150032 70 W SODYUM BUHARLI BALAST	4	ad.	23.590
078 038 150033	150033 100 W SODYUM BUHARLI BALAST	4	ad.	24.215
078 038 150034	150034 150 W SODYUM BUHARLI BALAST	4	ad.	35.756
078 038 150035	150035 250 W SODYUM BUHARLI BALAST	2	ad.	51.760
078 038 150036	150036 400 W SODYUM BUHARLI BALAST	2	ad.	68.528
078 038 150037	150037 600 W SODYUM BUHARLI BALAST	2	ad.	164.293
078 038 150038	150038 1000 W SODYUM BUHARLI BALAST	2	ad.	229.519

YÜKSEK BASINÇLI METAL HALİDE BALASTLAR

078 038 150040	150040 35 W METAL HALİDE BALAST	4	ad.	18.530
078 038 150041	150041 70 W METAL HALİDE BALAST	4	ad.	23.590
078 038 150042	150042 100 W METAL HALİDE BALAST	4	ad.	24.215
078 038 150043	150043 150 W METAL HALİDE BALAST	4	ad.	35.756
078 038 150044	150044 250 W METAL HALİDE BALAST	2	ad.	51.760
078 038 150045	150045 400 W METAL HALİDE BALAST	2	ad.	57.307
078 038 150046	150046 1000 W METAL HALİDE BALAST	2	ad.	215.684
078 038 150050	150050 70-400 W İGNİTÖR BALAST	20	ad.	18.286
078 038 150051	150051 1000 W İGNİTÖR BALAST	20	ad.	21.084

POLAR TS YOL AYDINLATMA ARMATÜRLERİ

078 038 060001	060001 160 W POLAR TS BOŞ GÖVDE	1	ad.	78.410
078 038 060125	060125 125 W POLAR TS CİVA BUHARLI	1	ad.	101.504
078 038 060110	060110 110 W POLAR TS SODYUM BUHARLI	1	ad.	101.504
078 038 060050	060050 50 W POLAR TS SODYUM BUHARLI	1	ad.	119.673
078 038 060070	060070 70 W POLAR TS SODYUM BUHARLI	1	ad.	125.741
078 038 060100	060100 100 W POLAR TS SODYUM BUHARLI	1	ad.	125.827
078 038 060150	060150 150 W POLAR TS SODYUM BUHARLI	1	ad.	129.553
078 038 060250	060250 250 W POLAR TS CİVA BUHARLI	1	ad.	147.744
078 038 060210	060210 210 W POLAR TS SODYUM BUHARLI	1	ad.	129.276
078 038 060002	060002 250 W POLAR BOŞ GÖVDE	1	ad.	81.348

ORİON MS YOL AYDINLATMA ARMATÜRLERİ

078 038 061001	061001 E 27 ORİON MS BOŞ GÖVDE	1	ad.	38.309
078 038 061125	061125 125 W ORİON MS CİVA BUHARLI	1	ad.	61.556
078 038 061110	061110 110 W ORİON MS SODYUM BUHARLI	1	ad.	61.556
078 038 061050	061050 50 W ORİON MS SODYUM BUHARLI	1	ad.	81.244
078 038 061070	061070 70 W ORİON MS SODYUM BUHARLI	1	ad.	84.227
078 038 061100	061100 100 W ORİON MS SODYUM BUHARLI	1	ad.	89.140

COSMOS CS YOL AYDINLATMA ARMATÜRLERİ

078 038 062001	062001 E 40 COSMOS CS BOŞ GÖVDE	1	ad.	97.590
078 038 063400	063400 400 W COSMOS CS CİVA BUHARLI	1	ad.	164.627
078 038 062350	062350 350 W COSMOS CS SODYUM BUHARLI	1	ad.	164.627
078 038 062250	062250 250 W COSMOS CS SODYUM BUHARLI	1	ad.	179.493
078 038 062400	062400 400 W COSMOS CS SODYUM BUHARLI	1	ad.	201.898

MUTLUSAN-S TİPİ POLYESTER CADDE ARMATÜRLERİ

066 038 910001	T-1000-01 160W E27 DUYLU BOŞ CADDE ARMATÜRÜ	1	ad.	32.400
066 038 910002	T-1000-02 125W CİVA BALASTLI CADDE ARMATÜRÜ	1	ad.	50.400
066 038 910003	T-1000-03 50W SODYUM BALASTLI CADDE ARMATÜRÜ	1	ad.	64.800
066 038 910004	T-1000-04 70W SODYUM BALASTLI CADDE ARMATÜRÜ	1	ad.	66.000

U TİPİ ETANJ ARMATÜRLER (AKRİLİK CAM-FİBERGLAS GÖVDE)

066 038 910236	T-2000-01 2X36 ETANJ ARMATÜR (AKRİLİK CAM)	1	ad.	49.200
066 038 910136	T-2000-02 1X36 ETANJ ARMATÜR (AKRİLİK CAM)	1	ad.	42.000
066 038 910218	T-2000-03 2X18 ETANJ ARMATÜR (AKRİLİK CAM)	1	ad.	37.200
066 038 910118	T-2000-04 1X18 ETANJ ARMATÜR (AKRİLİK CAM)	1	ad.	36.000

ARMATÜR ÇEŞİTLERİMİZ



Ürün Kodu : 001 038 020101 00 00
 Ürün Adı : FULYA TAVAN ARMATÜRÜ
 Ambalaj Ad. : 5
 Fiyat : 15.976 TL

Renk :



Ürün Kodu : 001 038 050101 00 00
 Ürün Adı : YASEMİN UFO KÜRE TAVAN ARM.
 Ambalaj Ad. : 12
 Fiyat : 11.890 TL

Renk :



Ürün Kodu : 001 038 020201 00 00
 Açıklama : FULYA DUVAR APLİK
 Ambalaj Ad. : 10
 Fiyat : 11.081 TL

Renk :



Ürün Kodu : 001 038 070101 00 00
 Ürün Adı : YASEMİN UFO DÜZ TAVAN ARM.
 Ambalaj Ad. : 12
 Fiyat : 11.709 TL

Renk :



Ürün Kodu : 001 038 010101 00 00
 Açıklama : MANOLYA TAVAN ARM.
 Ambalaj Ad. : 5
 Fiyat : 10.863 TL

Renk :

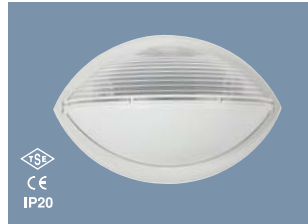

Ürün Kodu : 001 038 090101 00 00
 Ürün Adı : YASEMİN DUVAR APLİK
 Ambalaj Ad. : 8
 Fiyat : 11.785 TL

Renk :



Ürün Kodu : 001 038 010201 00 00
 Açıklama : MANOLYA DUVAR APLİK
 Ambalaj Ad. : 10
 Fiyat : 10.317 TL

Renk :

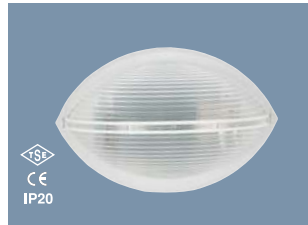

Ürün Kodu : 001 038 080101 00 00
 Ürün Adı : YASEMİN OVAL ARMATÜR
 Ambalaj Ad. : 8
 Fiyat : 11.357 TL

Renk :



Ürün Kodu : 001 038 030101 00 00
 Açıklama : YASEMİN DÜZ TAVAN ARM.
 Ambalaj Ad. : 12
 Fiyat : 13.587 TL

Renk :

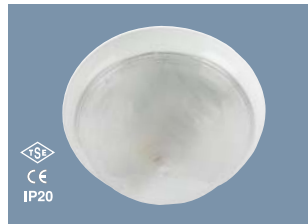

Ürün Kodu : 001 038 120101 00 00
 Ürün Adı : ORKİDE TAVAN ARMATÜRÜ
 Ambalaj Ad. : 24
 Fiyat : 5.630 TL

Renk :



Ürün Kodu : 001 038 060101 00 00
 Açıklama : YASEMİN KÜRE TAVAN ARM.
 Ambalaj Ad. : 12
 Fiyat : 14.046 TL

Renk :



Ürün Kodu : 001 038 160101 00 00
 Ürün Adı : YONCA TAVAN ARMATÜRÜ
 Ambalaj Ad. : 16
 Fiyat : 7.385 TL

Renk :



Ürün Kodu : 001 038 040101 00 00
 Açıklama : YASEMİN UFO TAVAN ARM.
 Ambalaj Ad. : 12
 Fiyat : 11.916 TL

Renk :



Ürün Kodu : 001 038 180101 00 00
 Ürün Adı : AKASYA TAVAN ARMATÜRÜ
 Ambalaj Ad. : 5
 Fiyat : 17.237 TL

Renk :

Not: Renkli armatürlerde fiyat sorunuz.

ARMATÜR ÇEŞİTLERİMİZ

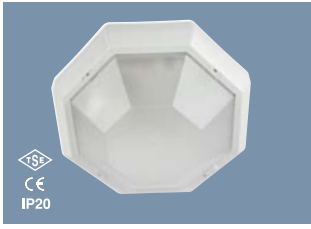

Ürün Kodu : 001 038 170101 00 00
 Ürün Adı : KAMELYA TAVAN ARMATÜRÜ
 Ambalaj Ad. : 1
 Fiyat : 16.466 TL

Renk :

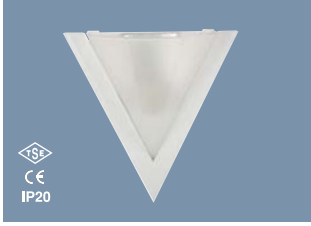

Ürün Kodu : 001 038 190201 00 00
 Ürün Adı : PİRAMİT APLİK
 Ambalaj Ad. : 1
 Fiyat : 9.249 TL

Renk :



Ürün Kodu : 001 038 110101 00 00
 Ürün Adı : MERVE TAVAN ARMATÜRÜ
 Ambalaj Ad. : 5
 Fiyat : 12.519 TL

Renk :



Ürün Kodu : 001 038 150101 00 00
 Ürün Adı : BEGONYA NEMLİ YER TAVAN ARMATÜRÜ (KLASİK)
 Ambalaj Ad. : 24
 Fiyat : 8.280 TL

Renk :



Ürün Kodu : 001 038 140101 00 00
 Ürün Adı : BEGONYA NEMLİ YER TAVAN ARMATÜRÜ (YATAY)
 Ambalaj Ad. : 12
 Fiyat : 8.363 TL

Renk :



Ürün Kodu : 001 038 130101 00 00
 Ürün Adı : BEGONYA NEMLİ YER TAVAN ARMATÜRÜ (DİKEY)
 Ambalaj Ad. : 12
 Fiyat : 8.280 TL

Renk :



Ürün Kodu : 001 038 250022 00 00
 Ürün Adı : 360 DRC.SENSÖRLÜ TAVAN GLOP ARMT.(2X25 W)
 Ambalaj Ad. : 5
 Fiyat : 28.000 TL

Renk :



Ürün Kodu : 001 038 250023 00 00
 Ürün Adı : LEDLİ SENSÖRLÜ TAVAN ARMATÜRÜ 2X25W

Ambalaj Ad. : 5
 Fiyat : 50.000 TL

Renk :



Ürün Kodu : 001 038 250024 00 00
 Ürün Adı : COMBO LEDLİ SENSÖRLÜ TAVAN ARMATÜRÜ 2X25W

Ambalaj Ad. : 5
 Fiyat : 46.000 TL

Renk :



Ürün Kodu : 001 038 250025 00 00
 Ürün Adı : COMBO LEDLİ SENSÖRLÜ TAVAN ARMATÜRÜ 2X25W

Ambalaj Ad. : 5
 Fiyat : 60.000 TL **PİL DAHİL**

Renk :



Ürün Kodu : 016 038 250025
 Ürün Adı : 32 W SİMİT ARMATÜR (ELK.BALANSTLI)

Ambalaj Ad. : 20
 Fiyat : 21.391 TL

Renk :



Ürün Kodu : 093 038 250026
 Ürün Adı : PRATİK 2 KOLLU 32 W SİMİT ARMATÜR

Ambalaj Ad. : 40
 Fiyat : 7.200 TL

Renk :



Ürün Kodu : 016 038 250031
 Ürün Adı : TAVAN GLOP ARMATÜRÜ (MİNİ) 75W

Ambalaj Ad. : 2
 Fiyat : 3.960 TL

Renk :



Ürün Kodu : 016 038 250036
 Ürün Adı : TAVAN GLOP ARMATÜRÜ (BÜYÜK) 75W

Ambalaj Ad. : 2
 Fiyat : 5.383 TL

Renk :

Not: Renkli armatürlerde fiyat sorunuz.

ARMATÜR ÇEŞİTLERİMİZ



Ürün Kodu : 016 038 250043
 Ürün Adı : TAVAN GLOP ARMATÜR
 (BÜYÜK MEGA)75W
 Ambalaj Ad. : 2
 Fiyat : 6.348 TL
 Renk :



Ürün Kodu : 016 038 250032
 Ürün Adı : TAVAN GLOP ARMATÜRÜ
 (MİDİ) 75W
 Ambalaj Ad. : 2
 Fiyat : 6.763 TL
 Renk :



Ürün Kodu : 016 038 250033
 Ürün Adı : TAVAN GLOP ARMATÜRÜ
 (MAXİ) 75W
 Ambalaj Ad. : 2
 Fiyat : 7.315 TL
 Renk :



Ürün Kodu : 016 038 250034
 Ürün Adı : TAVAN GLOP ARMATÜRÜ
 (MAXİ KAFESLİ) 75W
 Ambalaj Ad. : 2
 Fiyat : 8.280 TL
 Renk :

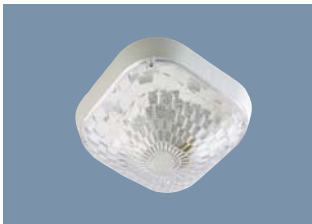

Ürün Kodu : 016 038 250014
 Ürün Adı : KARE TAVAN GLOP ARM.
 Ambalaj Ad. : 2
 Fiyat : 5.244 TL
 Renk :

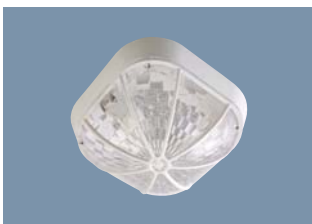

Ürün Kodu : 016 038 250015
 Ürün Adı : KARE TAVAN GLOP
 ARMATÜRÜ (KAFESLİ)
 Ambalaj Ad. : 2
 Fiyat : 6.072 TL
 Renk :



Ürün Kodu : 024 109 030001
 Ürün Adı : DUVAR APLİK PALMIYE
 Ambalaj Ad. : 2
 Fiyat : 4.800 TL
 Renk :



Ürün Kodu : 024 109 030002
 Ürün Adı : DUVAR APLİK İNCİ
 Ambalaj Ad. : 2
 Fiyat : 4.800 TL
 Renk :

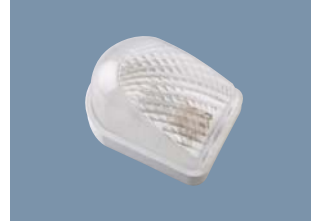

Ürün Kodu : 016 038 250013
 Ürün Adı : DUVAR APLİK (KRALİÇE)
 Ambalaj Ad. : 4
 Fiyat : 5.935 TL
 Renk :

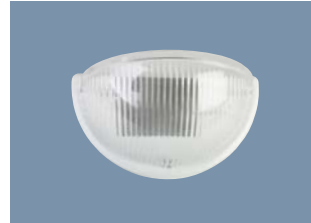

Ürün Kodu : 016 038 250037
 Ürün Adı : DUVAR APLİK (HİLAL)
 Ambalaj Ad. : 4
 Fiyat : 4.003 TL
 Renk :

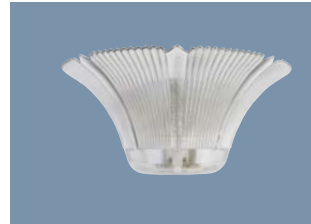

Ürün Kodu : 016 038 250038
 Ürün Adı : DUVAR APLİK (YELPAZE)
 Ambalaj Ad. : 4
 Fiyat : 5.796 TL
 Renk :



Ürün Kodu : 016 038 250028
 Ürün Adı : OVAL DÜZ ARMATÜR
 Ambalaj Ad. : 2
 Fiyat : 6.955 TL
 Renk :



Ürün Kodu : 016 038 250029
 Ürün Adı : OVAL KAFESLİ ARMATÜR
 Ambalaj Ad. : 2
 Fiyat : 7.231 TL
 Renk :



Ürün Kodu : 016 038 250030
 Ürün Adı : OVAL ŞAPKALI ARMATÜR
 Ambalaj Ad. : 2
 Fiyat : 7.536 TL
 Renk :

ARMATÜR ÇEŞİTLERİMİZ



Ürün Kodu : 016 038 250039
 Ürün Adı : NEMLİYER OVAL DÜZ ARM.
 Ambalaj Ad. : 2
 Fiyat : 7.315 TL

Renk :



Ürün Kodu : 016 038 250040
 Ürün Adı : NEMLİYER OVAL KAFESLİ ARM.
 Ambalaj Ad. : 2
 Fiyat : 7.591 TL

Renk :



Ürün Kodu : 016 038 250041
 Ürün Adı : NEMLİYER OVAL ŞAPKALI ARM.
 Ambalaj Ad. : 2
 Fiyat : 7.728 TL

Renk :



Ürün Kodu : 001 038 250018 00 00
 Ürün Adı : HAZIR ASKI TİJ TAKIMI
 Ambalaj Ad. : 25
 Fiyat : 1.074 TL

Renk :



Ürün Kodu : 001 038 250016 00 00
 Ürün Adı : PAPATYA ASKI TİJ TAKIMI
 Ambalaj Ad. : 25
 Fiyat : 1.132 TL

Renk :



Ürün Kodu : 001 038 250017 00 00
 Ürün Adı : BÜYÜK PAPATYA ASKI TİJ TAKIMI
 Ambalaj Ad. : 10
 Fiyat : 1.877 TL

Renk :

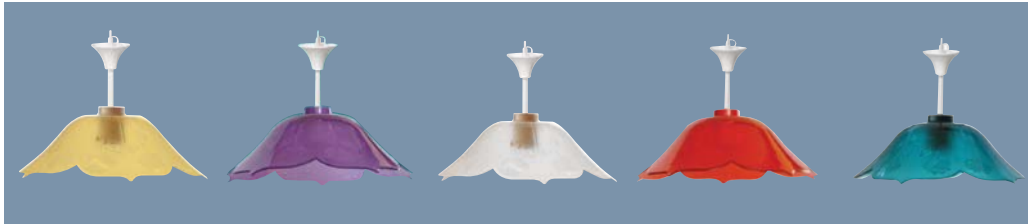

Ürün Kodu : 024 038 250019
 Ürün Adı : SARKIT ARMATÜR POLYKARBONAT PORS.DUYLU.BEŞ.RENK
 Ambalaj Ad. : 5
 Fiyat : 5.935 TL

Ürün Kodu Açıklama / Stok Cinsi Ambalaj Adedi Ambalaj birimi TL

RALİNA DUY VE SETLERİ

016 038 220001	RALİNA DUY (DÜZ)	48	ad.	2.100
016 038 220002	RALİNA DUY (ANAHTARLI)	48	ad.	4.198
016 038 220003	RALİNA DUY (İPLİ)	48	ad.	4.198
016 038 240001	RALİNA 35 W (DÜZ)	25	ad.	4.478
016 038 240002	RALİNA 35 W (DÜZ PRİZLİ)	25	ad.	7.277
016 038 240003	RALİNA 35 W (ANAHTARLI)	25	ad.	7.277
016 038 240006	RALİNA 35 W (ANAHTARLI PRİZLİ)	25	ad.	10.075
016 038 240005	RALİNA 35 W (İPLİ)	25	ad.	7.277
016 038 240006	RALİNA 35 W (İPLİ PRİZLİ)	25	ad.	10.075
016 038 240007	RALİNA 60 W (DÜZ)	25	ad.	5.878
016 038 240008	RALİNA 60 W (DÜZ PRİZLİ)	25	ad.	8.676
016 038 240009	RALİNA 60 W (ANAHTARLI)	25	ad.	8.395
016 038 240010	RALİNA 60 W (ANAHTARLI PRİZLİ)	25	ad.	11.194
016 038 240011	RALİNA 60 W (İPLİ)	25	ad.	8.395
016 038 240012	RALİNA 60 W (İPLİ PRİZLİ)	25	ad.	11.194
016 038 230001	RALİNA ARMATÜR ŞAPKASI 35 W (HAREKETLİ)	10	ad.	3.485
016 038 230002	RALİNA ARMATÜR ŞAPKASI 60 W (HAREKETLİ)	10	ad.	4.198

PLASTİK GLOP CAM ÇEŞİTLERİ

020 108 000001	PLASTİK GLOP CAMI	100	ad.	1.680
020 108 000020	20'LİK PLASTİK GLOP CAMI	50	ad.	4.800
020 108 000025	25'LİK PLASTİK GLOP CAMI	25	ad.	6.720
020 108 000030	30'LÜK PLASTİK GLOP CAMI	15	ad.	9.120
020 108 000035	35'LİK PLASTİK GLOP CAMI	10	ad.	20.160

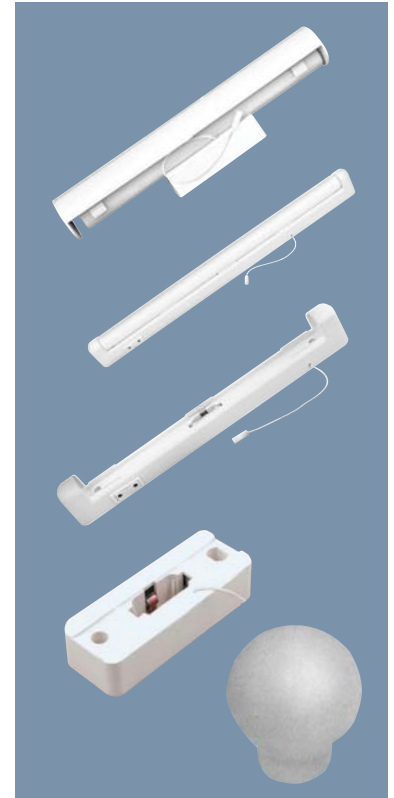



Ürün Kodu	Açıklama / Stok Cinsi	Ambalaj (Kutulu)	Ambalaj Birimi	TL
-----------	-----------------------	------------------	----------------	----

T-5 LEDLİ ARMATÜRLER

102 038 518012	CLAT 5-18 W (12 V)	1	ad.	25.920
102 038 518220	CLAT 5-18 W (220 V)	1	ad.	29.520
102 038 513012	CLAT 5-13 W (12 V)	1	ad.	16.800
102 038 513220	CLAT 5-13 W (220 V)	1	ad.	20.400
102 038 510812	CLAT 5-8 W (12 V)	1	ad.	15.000
102 038 508220	CLAT 5-8 W (220 V)	1	ad.	18.600
102 038 506012	CLAT 5-6 W (12 V)	1	ad.	12.480
102 038 506220	CLAT 5-6 W (220 V)	1	ad.	16.080
102 038 504012	CLAT 5-4 W (12 V)	1	ad.	10.800
102 038 504220	CLAT 5-4 W (220 V)	1	ad.	14.400

LEDLİ ŞARJLI IŞILDAKLAR

102 038 000004	LEDLİ IŞILDAK (60 LEDLİ)	1	ad.	22.800 USD
102 038 000005	LEDLİ IŞILDAK (90 LEDLİ)	1	ad.	31.200 USD

İTHAL PROJEKTÖRLER

888 038 273150	150 W PROJEKTÖR (NORMAL)	1	ad.	5.280 USD
888 038 274150	150 W PROJEKTÖR (SENSÖRLÜ)	1	ad.	15.600 USD
888 038 273500	500 W PROJEKTÖR (NORMAL)	1	ad.	7.200 USD
888 038 274500	500 W PROJEKTÖR (SENSÖRLÜ)	1	ad.	18.000 USD
888 038 273100	1000 W PROJEKTÖR (NORMAL)	1	ad.	15.000 USD

EXIT- ŞEFFAF ACİL AYDINLATMA ARMATÜRLERİ (LEDLİ)

102 038 000801 CEXA-8-01 43.200 TL	102 038 000802 CEXA-8-02 43.200 TL	102 038 000803 CEXA-8-03 43.200 TL	102 038 000804 CEXA-8-04 43.200 TL	102 038 000805 CEXA-8-05 43.200 TL	102 038 000806 CEXA-8-06 43.200 TL	102 038 000807 CEXA-8-07 43.200 TL
102 038 000808 CEXA-8-08 43.200 TL	102 038 000809 CEXA-8-09 43.200 TL	102 038 000810 CEXA-8-10 43.200 TL	102 038 000811 CEXA-8-11 43.200 TL	102 038 000812 CEXA-8-12 43.200 TL	102 038 000813 CEXA-8-13 43.200 TL	102 038 000814 CEXA-8-14 43.200 TL
102 038 000815 CEXA-8-15 43.200 TL	102 038 000816 CEXA-8-16 43.200 TL	102 038 000817 CEXA-8-17 43.200 TL	102 038 000818 CEXA-8-18 43.200 TL	102 038 000819 CEXA-8-19 43.200 TL	102 038 000820 CEXA-8-20 43.200 TL	102 038 000821 CEXA-8-21 43.200 TL
102 038 000822 CEXA-8-22 43.200 TL	102 038 000823 CEXA-8-23 43.200 TL	102 038 000824 CEXA-8-24 43.200 TL	102 038 000825 CEXA-8-25 43.200 TL	102 038 000826 CEXA-8-26 43.200 TL	102 038 000827 CEXA-8-27 43.200 TL	

The first part of the document discusses the importance of maintaining accurate records of all transactions. It emphasizes that every entry, no matter how small, should be recorded to ensure the integrity of the financial statements. This includes not only sales and purchases but also expenses, income, and transfers.

The second part of the document provides a detailed breakdown of the accounting cycle. It outlines the ten steps involved in the process, from identifying the accounting entity to preparing financial statements. Each step is explained in detail, with examples provided to illustrate the concepts.

The third part of the document discusses the various types of accounts used in accounting. It categorizes accounts into assets, liabilities, equity, revenue, and expense accounts. It also explains the normal balances for each type of account and how they are used to calculate the net income or loss for a period.

The fourth part of the document discusses the importance of adjusting entries. It explains how these entries are used to ensure that the financial statements reflect the true financial position of the company at the end of the period. Examples are provided for each of the four types of adjusting entries: accrued expenses, accrued revenues, prepaid expenses, and unearned revenues.

The fifth part of the document discusses the importance of closing entries. It explains how these entries are used to transfer the balances of the temporary accounts (revenue, expense, and dividend) to the permanent accounts (retained earnings and dividends). This process resets the temporary accounts for the next period and updates the retained earnings account.

The sixth part of the document discusses the importance of the trial balance. It explains how the trial balance is used to verify the accuracy of the accounting records. It shows how the total debits should equal the total credits, and how any discrepancies can be identified and corrected.

The seventh part of the document discusses the importance of the financial statements. It explains how the income statement, balance sheet, and statement of cash flows are prepared and how they provide valuable information to management and other stakeholders.

The eighth part of the document discusses the importance of the accounting cycle. It explains how the cycle is used to ensure that the accounting records are up-to-date and accurate. It also discusses the importance of maintaining a good system of internal controls to prevent errors and fraud.

The ninth part of the document discusses the importance of the accounting profession. It explains the role of accountants and the various organizations that regulate the profession. It also discusses the importance of continuing education and staying up-to-date on the latest accounting standards and practices.

The tenth part of the document discusses the importance of ethics in accounting. It explains the various ethical dilemmas that accountants may face and the importance of following the code of ethics. It also discusses the consequences of unethical behavior and the importance of maintaining the highest standards of integrity.



OTOMASYON

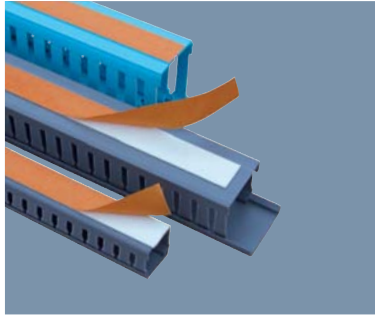
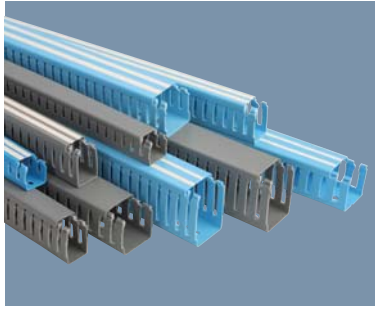
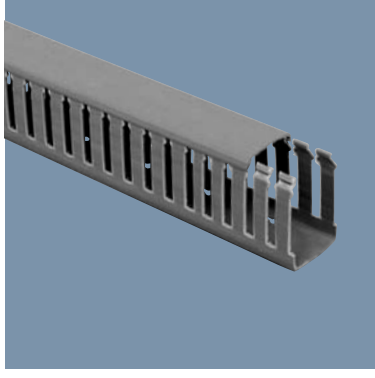

KABLO TUTUCU APARATI

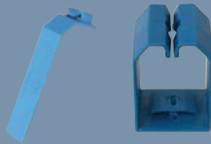
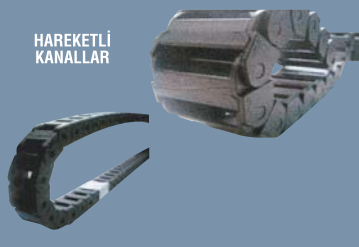
HAREKETLİ
KANALLAR

Ürün Kodu	Açıklama / Stok Cinsi	Ambalaj (Kutulu)	Ambalaj Birimi	TL
PANO İÇİN SÜPER LÜX KANALLAR (GRİ)				
001 005 025025 20 17	25X25 KABLO KAN.(DELİKLİ)(GRİ)	2 M	128 mt.	1.844
001 005 025040 20 17	25X40 KABLO KAN.(DELİKLİ)(GRİ)	2 M	80 mt.	2.961
001 005 025060 20 17	25X60 KABLO KAN.(DELİKLİ)(GRİ)	2 M	72 mt.	3.605
001 005 040040 20 17	40X40 KABLO KAN.(DELİKLİ)(GRİ)	2 M	50 mt.	3.257
001 005 040060 20 17	40X60 KABLO KAN.(DELİKLİ)(GRİ)	2 M	48 mt.	4.254
001 005 060040 20 17	60X40 KABLO KAN.(DELİKLİ)(GRİ)	2 M	48 mt.	4.254
001 005 060060 20 17	60X60 KABLO KAN.(DELİKLİ)(GRİ)	2 M	32 mt.	4.893
001 005 040080 20 17	40X80 KABLO KAN.(DELİKLİ)(GRİ)	2 M	32 mt.	5.768
001 005 080060 20 17	80X60 KABLO KAN.(DELİKLİ)(GRİ)	2 M	24 mt.	6.438
001 005 100060 20 17	100X60 KABLO KAN.(DELİKLİ)(GRİ)	2 M	16 mt.	7.725

PANO İÇİN SÜPER LÜX KANALLAR (MAVİ-BEYAZ ŞERİT)				
001 005 025025 20 13	25X25 KABLO KAN.(DELİKLİ)(MAVİ)	2 M	128 mt.	1.968
001 005 025040 20 13	25X40 KABLO KAN.(DELİKLİ)(MAVİ)	2 M	80 mt.	3.090
001 005 025060 20 13	25X60 KABLO KAN.(DELİKLİ)(MAVİ)	2 M	72 mt.	3.692
001 005 040040 20 13	40X40 KABLO KAN.(DELİKLİ)(MAVİ)	2 M	50 mt.	3.392
001 005 040060 20 13	40X60 KABLO KAN.(DELİKLİ)(MAVİ)	2 M	48 mt.	4.590
001 005 060040 20 13	60X40 KABLO KAN.(DELİKLİ)(MAVİ)	2 M	48 mt.	4.439
001 005 060060 20 13	60X60 KABLO KAN.(DELİKLİ)(MAVİ)	2 M	32 mt.	5.111
001 005 040080 20 13	40X80 KABLO KAN.(DELİKLİ)(MAVİ)	2 M	32 mt.	5.768
001 005 080060 20 13	80X60 KABLO KAN.(DELİKLİ)(MAVİ)	2 M	24 mt.	7.110
001 005 100060 20 13	100X60 KABLO KAN.(DELİKLİ)(MAVİ)	2 M	16 mt.	8.158

YAPIŞKAN BANTLI DELİKLİ KANALLAR (MAVİ-BEYAZ)				
001 008 025025 20 13	25X25 MM DEL.KANAL YPŞK.BANTLI (MAVİ)	2 M	128 mt.	2.253
001 008 025040 20 13	25X40 MM DEL.KANAL YPŞK.BANTLI (MAVİ)	2 M	80 mt.	3.538
001 008 025060 20 13	25X60 MM DEL.KANAL YPŞK.BANTLI (MAVİ)	2 M	72 mt.	4.193
001 008 040040 20 13	40X40 MM DEL.KANAL YPŞK.BANTLI (MAVİ)	2 M	50 mt.	3.873
001 008 040060 20 13	40X60 MM DEL.KANAL YPŞK.BANTLI (MAVİ)	2 M	48 mt.	5.190
001 008 060040 20 13	60X40 MM DEL.KANAL YPŞK.BANTLI (MAVİ)	2 M	48 mt.	6.014
001 008 060060 20 13	60X60 MM DEL.KANAL YPŞK.BANTLI (MAVİ)	2 M	32 mt.	6.171
001 008 040080 20 13	40X80 MM DEL.KANAL YPŞK.BANTLI (MAVİ)	2 M	32 mt.	6.345
001 008 080060 20 13	80X60 MM DEL.KANAL YPŞK.BANTLI (MAVİ)	2 M	24 mt.	9.219
001 008 100060 20 13	100X60 MM DEL.KANAL YPŞK.BANTLI (MAVİ)	2 M	16 mt.	10.575

YAPIŞKAN BANTLI DELİKLİ KANALLAR (GRİ)				
001 008 025025 20 17	25*25 MM DEL.KANAL YPŞK.BANTLI (GRİ)	2 M	128 mt.	2.127
001 008 025040 20 17	25*40 MM DEL.KANAL YPŞK.BANTLI (GRİ)	2 M	80 mt.	3.407
001 008 025060 20 17	25*60 MM DEL.KANAL YPŞK.BANTLI (GRİ)	2 M	72 mt.	4.193
001 008 040040 20 17	40*40 MM DEL.KANAL YPŞK.BANTLI (GRİ)	2 M	50 mt.	3.703
001 008 040060 20 17	40*60 MM DEL.KANAL YPŞK.BANTLI (GRİ)	2 M	48 mt.	4.699
001 008 060040 20 17	60*40 MM DEL.KANAL YPŞK.BANTLI (GRİ)	2 M	48 mt.	4.990
001 008 060060 20 17	60*60 MM DEL.KANAL YPŞK.BANTLI (GRİ)	2 M	32 mt.	5.629
001 008 040080 20 17	40*80 MM DEL.KANAL YPŞK.BANTLI (GRİ)	2 M	32 mt.	6.345
001 008 080060 20 17	80*60 MM DEL.KANAL YPŞK.BANTLI (GRİ)	2 M	24 mt.	7.174
001 008 100060 20 17	100*60 MM DEL.KANAL YPŞK.BANTLI (GRİ)	2 M	16 mt.	8.886

DELİKLİ KABLO KANAL AKSESUARLARI				
001 050 010001 00 00	25X40 DEL.KANAL KABLO TUTUCU APARATI	40	ad.	0.349
001 050 010002 00 00	40X40 DEL.KANAL KABLO TUTUCU APARATI	60	ad.	0.351
001 050 010003 00 00	40X60 DEL.KANAL KABLO TUTUCU APARATI	40	ad.	0.417
001 050 010004 00 00	60X60 DEL.KANAL KABLO TUTUCU APARATI	24	ad.	0.460
001 050 020001 00 00	40X40/60 DEL.KANAL KAB.TUTUCU YAN APRT.	100	ad.	0.192
001 050 020002 00 00	60X40/60 DEL.KANAL KAB.TUTUCU YAN APRT.	100	ad.	0.178
001 050 020003 00 00	80X60 DEL.KANAL KAB.TUTUCU YAN APRT.	100	ad.	0.240
001 050 020004 00 00	100X60 DEL.KANAL KAB.TUTUCU YAN APRT.	100	ad.	0.296

HAREKETLİ KABLO KANALLARI				
888 140 000610	6X10 MM HAREKETLİ KABLO KANALI	1	ad.	8.841 USD.
888 140 001020	10X20 MM HAREKETLİ KABLO KANALI	1	ad.	11.693 USD.
888 140 001530	15X30 MM HAREKETLİ KABLO KANALI	1	ad.	14.616 USD.
888 140 001825	18X25 MM HAREKETLİ KABLO KANALI	1	ad.	17.539 USD.
888 140 003060	30X60 MM HAREKETLİ KABLO KANALI	1	ad.	32.831 USD.

Ürün Kodu	Açıklama / Stok Cinsi	Ambalaj (Kutulu)	Ambalaj Birimi	TL
-----------	-----------------------	------------------	----------------	----

PANO FİLTRESİ

054 126 020002	120X120 PANO FİLTRESİ	1	ad.	4.500
----------------	-----------------------	---	-----	-------

FG-VG 2501 2.5KV CAM ELYAF MAKARONLAR

065 141 010001	1 MM BEYAZ ÜZERİ ÇİZGİLİ-SİYAH MAKARON CAM ELYAF	100	mt.	0.048 USD.
065 141 010002	1,50 MM BEYAZ ÜZERİ ÇİZGİLİ-SİYAH MAKARON CAM ELYAF	100	mt.	0.060 USD.
065 141 010003	2 MM BEYAZ ÜZERİ ÇİZGİLİ-SİYAH MAKARON CAM ELYAF	100	mt.	0.066 USD.
065 141 010004	2,50 MM BEYAZ ÜZERİ ÇİZGİLİ-SİYAH MAKARON CAM ELYAF	100	mt.	0.078 USD.
065 141 010005	3 MM BEYAZ ÜZERİ ÇİZGİLİ-SİYAH MAKARON CAM ELYAF	100	mt.	0.094 USD.
065 141 010006	3,5 MM BEYAZ ÜZERİ ÇİZGİLİ-SİYAH MAKARON CAM ELYAF	100	mt.	0.115 USD.
065 141 010007	4 MM BEYAZ ÜZERİ ÇİZGİLİ-SİYAH MAKARON CAM ELYAF	100	mt.	0.122 USD.
065 141 010008	5 MM BEYAZ ÜZERİ ÇİZGİLİ-SİYAH MAKARON CAM ELYAF	100	mt.	0.228 USD.
065 141 010009	6 MM BEYAZ ÜZERİ ÇİZGİLİ-SİYAH MAKARON CAM ELYAF	100	mt.	0.245 USD.
065 141 010010	7 MM BEYAZ ÜZERİ ÇİZGİLİ-SİYAH MAKARON CAM ELYAF	100	mt.	0.300 USD.
065 141 010011	8 MM BEYAZ ÜZERİ ÇİZGİLİ-SİYAH MAKARON CAM ELYAF	50	mt.	0.302 USD.
065 141 010012	10 MM BEYAZ ÜZERİ ÇİZGİLİ-SİYAH MAKARON CAM ELYAF	50	mt.	0.439 USD.
065 141 010013	12 MM BEYAZ ÜZERİ ÇİZGİLİ-SİYAH MAKARON CAM ELYAF	50	mt.	0.576 USD.
065 141 010014	14 MM BEYAZ ÜZERİ ÇİZGİLİ-SİYAH MAKARON CAM ELYAF	50	mt.	0.720 USD.
065 141 010015	16 MM BEYAZ ÜZERİ ÇİZGİLİ-SİYAH MAKARON CAM ELYAF	50	mt.	1.282 USD.
065 141 010016	18 MM BEYAZ ÜZERİ ÇİZGİLİ-SİYAH MAKARON CAM ELYAF	50	mt.	1.325 USD.
065 141 010017	20 MM BEYAZ ÜZERİ ÇİZGİLİ-SİYAH MAKARON CAM ELYAF	25	mt.	2.189 USD.
065 141 010018	25 MM BEYAZ ÜZERİ ÇİZGİLİ-SİYAH MAKARON CAM ELYAF	25	mt.	4.752 USD.

FG-SRG 5KV H CLASS CAM+SİLİKON MAKARONLAR

065 141 020002	1 MM KIRMIZI-SİYAH CAM+SİLİKON MAKARON	100	mt.	0.543
065 141 020003	1,50 MM KIRMIZI- SİYAH CAM+SİLİKON MAKARON	100	mt.	0.622
065 141 020004	2 MM KIRMIZI- SİYAH CAM+SİLİKON MAKARON	100	mt.	0.750
065 141 020005	2,50 MM KIRMIZI- SİYAH CAM+SİLİKON MAKARON	100	mt.	0.802
065 141 020006	3 MM KIRMIZI- SİYAH CAM+SİLİKON MAKARON	100	mt.	0.984
065 141 020007	3,5 MM KIRMIZI- SİYAH CAM+SİLİKON MAKARON	100	mt.	1.166
065 141 020008	4 MM KIRMIZI-SİYAH CAM+SİLİKON MAKARON	100	mt.	1.296
065 141 020009	5 MM KIRMIZI-SİYAH CAM+SİLİKON MAKARON	100	mt.	1.555
065 141 020010	6 MM KIRMIZI-SİYAH CAM+SİLİKON MAKARON	100	mt.	1.839
065 141 020011	7 MM KIRMIZI-SİYAH CAM+SİLİKON MAKARON	100	mt.	2.359
065 141 020012	8 MM KIRMIZI-SİYAH CAM+SİLİKON MAKARON	50	mt.	2.746
065 141 020013	10 MM KIRMIZI-SİYAH CAM+SİLİKON MAKARON	50	mt.	2.798
065 141 020014	12 MM KIRMIZI-SİYAH CAM+SİLİKON MAKARON	50	mt.	4.069
065 141 020015	14 MM KIRMIZI-SİYAH CAM+SİLİKON MAKARON	50	mt.	4.975
065 141 020016	16 MM KIRMIZI-SİYAH CAM+SİLİKON MAKARON	50	mt.	6.401
065 141 020017	18 MM KIRMIZI-SİYAH CAM+SİLİKON MAKARON	50	mt.	7.826
065 141 020018	20 MM KIRMIZI-SİYAH CAM+SİLİKON MAKARON	25	mt.	9.122
065 141 020019	25 MM KIRMIZI-SİYAH CAM+SİLİKON MAKARON	25	mt.	18.793
065 141 020020	30 MM KIRMIZI-SİYAH CAM+SİLİKON MAKARON	25	mt.	24.882
065 141 020021	35 MM KIRMIZI-SİYAH CAM+SİLİKON MAKARON	25	mt.	30.319

YKC KABLO ÇORAPLARI

065 100 160001	YKC 3 MM KABLO ÇORABI SİYAH	1000	mt.	0.374 EUR.
065 100 160002	YKC 6 MM KABLO ÇORABI SİYAH	1000	mt.	0.432 EUR.
065 100 160003	YKC 10 MM KABLO ÇORABI SİYAH	100	mt.	0.504 EUR.
065 100 160004	YKC 12 MM KABLO ÇORABI SİYAH	100	mt.	0.619 EUR.
065 100 160005	YKC 15 MM KABLO ÇORABI SİYAH	100	mt.	0.749 EUR.
065 100 160006	YKC 20 MM KABLO ÇORABI SİYAH	100	mt.	0.936 EUR.
065 100 160007	YKC 25 MM KABLO ÇORABI SİYAH	100	mt.	1.195 EUR.
065 100 160008	YKC 30 MM KABLO ÇORABI SİYAH	50	mt.	1.296 EUR.
065 100 160009	YKC 40 MM KABLO ÇORABI SİYAH	50	mt.	1.728 EUR.
065 100 160010	YKC 50 MM KABLO ÇORABI SİYAH	50	mt.	2.016 EUR.

NOT:GRİ-KIRMIZI-MAVİ-SARI VE BEYAZ RENKLERİ MEVCUTTUR.

ISI İLE DARALAN MAKARONLAR

065 141 030001	1,5 MM ISI İLE DARALAN MAKARON	200	mt.	0.078 USD.
065 141 030002	2,5 MM ISI İLE DARALAN MAKARON	200	mt.	0.090 USD.
065 141 030003	3 MM ISI İLE DARALAN MAKARON	200	mt.	0.106 USD.
065 141 030004	3,2 MM ISI İLE DARALAN MAKARON	200	mt.	0.106 USD.
065 141 030005	3,5 MM ISI İLE DARALAN MAKARON	200	mt.	0.110 USD.

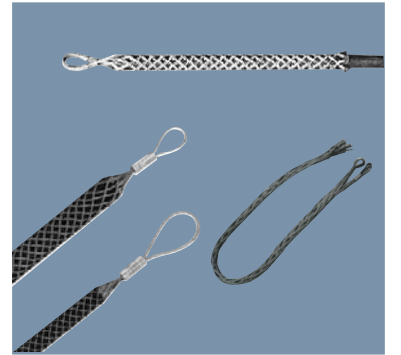
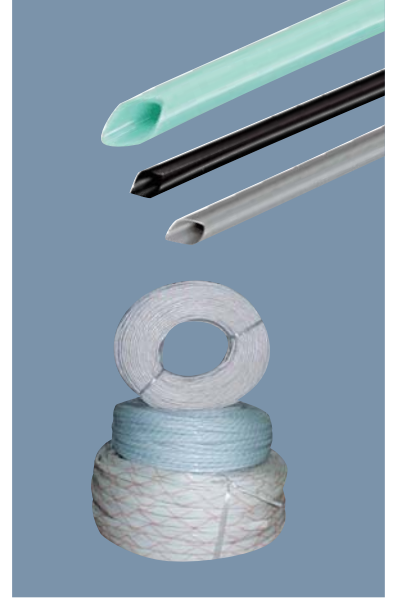

MAKARONLAR
RoHS BELGELİDİR

Ürün Kodu	Açıklama / Stok Cinsi	Ambalaj (Kutulu)	Ambalaj Birimi	TL
ISI İLE DARALAN MAKARONLAR				
065 141 030006	4 MM ISI İLE DARALAN MAKARON	200	mt.	0.120 USD.
065 141 030007	4,5 MM ISI İLE DARALAN MAKARON	100	mt.	0.132 USD.
065 141 030008	4,8 MM ISI İLE DARALAN MAKARON	100	mt.	0.132 USD.
065 141 030009	5 MM ISI İLE DARALAN MAKARON	100	mt.	0.144 USD.
065 141 030010	6 MM ISI İLE DARALAN MAKARON	100	mt.	0.156 USD.
065 141 030011	6,4 MM ISI İLE DARALAN MAKARON	100	mt.	0.156 USD.
065 141 030012	7 MM ISI İLE DARALAN MAKARON	100	mt.	0.172 USD.
065 141 030013	8 MM ISI İLE DARALAN MAKARON	100	mt.	0.186 USD.
065 141 030014	9,5 MM ISI İLE DARALAN MAKARON	100	mt.	0.192 USD.
065 141 030015	10 MM ISI İLE DARALAN MAKARON	100	mt.	0.204 USD.
065 141 030016	12,7 MM ISI İLE DARALAN MAKARON	100	mt.	0.252 USD.
065 141 030017	13 MM ISI İLE DARALAN MAKARON	100	mt.	0.252 USD.
065 141 030018	16 MM ISI İLE DARALAN MAKARON	50	mt.	0.276 USD.
065 141 030019	18 MM ISI İLE DARALAN MAKARON	50	mt.	0.480 USD.
065 141 030020	19,1 MM ISI İLE DARALAN MAKARON	50	mt.	0.600 USD.
065 141 030021	20 MM ISI İLE DARALAN MAKARON	50	mt.	0.708 USD.
065 141 030022	22 MM ISI İLE DARALAN MAKARON	50	mt.	0.708 USD.
065 141 030023	25 MM ISI İLE DARALAN MAKARON	50	mt.	0.816 USD.
065 141 030024	30 MM ISI İLE DARALAN MAKARON	50	mt.	0.864 USD.
065 141 030025	35 MM ISI İLE DARALAN MAKARON	50	mt.	1.560 USD.
065 141 030026	40 MM ISI İLE DARALAN MAKARON	50	mt.	1.980 USD.
065 141 030027	50 MM ISI İLE DARALAN MAKARON	25	mt.	2.040 USD.
065 141 030028	60 MM ISI İLE DARALAN MAKARON	25	mt.	3.000 USD.
065 141 030029	70 MM ISI İLE DARALAN MAKARON	25	mt.	4.320 USD.
065 141 030030	80 MM ISI İLE DARALAN MAKARON	25	mt.	5.760 USD.
065 141 030031	90 MM ISI İLE DARALAN MAKARON	25	mt.	6.600 USD.
065 141 030032	100 MM ISI İLE DARALAN MAKARON	25	mt.	7.680 USD.
065 141 030033	120 MM ISI İLE DARALAN MAKARON	15	mt.	7.800 USD.

HELEZON PANO SİRİALİ

023 020 500000	NO. 0 HELEZON PANO SİRİALİ (BOY: 50CM)	100	ad.	0.138
023 020 500001	NO. 1 HELEZON PANO SİRİALİ (BOY: 50CM)	100	ad.	0.165
023 020 500002	NO. 2 HELEZON PANO SİRİALİ (BOY: 50CM)	100	ad.	0.213
023 020 500003	NO. 3 HELEZON PANO SİRİALİ (BOY: 50CM)	100	ad.	0.400
023 020 500004	NO. 4 HELEZON PANO SİRİALİ (BOY: 50CM)	50	ad.	0.695
023 020 500005	NO. 5 HELEZON PANO SİRİALİ (BOY: 50CM)	50	ad.	0.955

HELEZON PANO SİRİALİ (RULO)

023 020 600001	NO. 1 HELEZON PANO SİRİALİ (100 MT.LİK RULO)	100	mt.	0.350
023 020 600002	NO. 2 HELEZON PANO SİRİALİ (100 MT.LİK RULO)	100	mt.	0.413
023 020 600003	NO. 3 HELEZON PANO SİRİALİ (100 MT.LİK RULO)	100	mt.	0.793
023 020 600004	NO. 4 HELEZON PANO SİRİALİ (50 MT.LİK RULO)	50	mt.	1.383
023 020 600005	NO. 5 HELEZON PANO SİRİALİ (50 MT.LİK RULO)	50	mt.	1.925

İTHAL KABLO BAĞLARI (MEKS)

888 129 325100	KABLO BAĞI 2.5X100	100	ad.	0.004 USD.
888 129 325150	KABLO BAĞI 2.5X150	100	ad.	0.008 USD.
888 129 325200	KABLO BAĞI 2.5X200	100	ad.	0.012 USD.
888 129 335150	KABLO BAĞI 3.5X150	100	ad.	0.012 USD.
888 129 335200	KABLO BAĞI 3.5X200	100	ad.	0.016 USD.
888 129 335250	KABLO BAĞI 3.5X250	100	ad.	0.022 USD.
888 129 335280	KABLO BAĞI 3.5X280	100	ad.	0.023 USD.
888 129 335300	KABLO BAĞI 3.5X300	100	ad.	0.026 USD.
888 129 348200	KABLO BAĞI 4.8X200	100	ad.	0.022 USD.
888 129 348250	KABLO BAĞI 4.8X250	100	ad.	0.029 USD.
888 129 348300	KABLO BAĞI 4.8X300	100	ad.	0.034 USD.
888 129 348350	KABLO BAĞI 4.8X350	100	ad.	0.038 USD.
888 129 348370	KABLO BAĞI 4.8X370	100	ad.	0.044 USD.
888 129 348400	KABLO BAĞI 4.8X400	100	ad.	0.044 USD.
888 129 307300	KABLO BAĞI 7X300	100	ad.	0.059 USD.
888 129 307350	KABLO BAĞI 7X350	100	ad.	0.076 USD.
888 129 307400	KABLO BAĞI 7X400	100	ad.	0.083 USD.
888 129 307450	KABLO BAĞI 7X450	100	ad.	0.102 USD.
888 129 309550	KABLO BAĞI 9X550	100	ad.	0.165 USD.
888 129 309650	KABLO BAĞI 9X650	100	ad.	0.186 USD.
888 129 309750	KABLO BAĞI 9X750	100	ad.	0.197 USD.
888 129 391020	KABLO BAĞI 9X1020	100	ad.	0.364 USD.
888 129 302020	YAPIŞKANLI KROŞE 20X20	100	ad.	0.038 USD.
888 129 302828	YAPIŞKANLI KROŞE 28X28	100	ad.	0.055 USD.

Ürün Kodu	Açıklama / Stok Cinsi	Ambalaj (Kutulu)	Ambalaj Birimi	TL
PASLANMAZ ÇELİK KABLO BAĞLARI				
888 129 504615	PASLANMAZ ÇELİK KABLO BAĞI 4,6X150 MM	100	ad.	0.422 USD.
888 129 504617	PASLANMAZ ÇELİK KABLO BAĞI 4,6X175 MM	100	ad.	0.464 USD.
888 129 508150	PASLANMAZ ÇELİK KABLO BAĞI 8X150 MM	100	ad.	0.717 USD.
888 129 508175	PASLANMAZ ÇELİK KABLO BAĞI 8X175 MM	100	ad.	0.759 USD.
888 129 508300	PASLANMAZ ÇELİK KABLO BAĞI 8X300 MM	100	ad.	0.844 USD.
888 129 508350	PASLANMAZ ÇELİK KABLO BAĞI 8X350 MM	100	ad.	0.928 USD.
888 129 508600	PASLANMAZ ÇELİK KABLO BAĞI 8X400 MM	100	ad.	0.970 USD.
888 129 508500	PASLANMAZ ÇELİK KABLO BAĞI 8X500 MM	100	ad.	1.012 USD.
888 129 508600	PASLANMAZ ÇELİK KABLO BAĞI 8X600 MM	100	ad.	1.055 USD.

PEMSAN YERLİ KABLO BAĞLARI-(SİYAH-BEYAZ)				
062 129 010101	EA.01.101 BONCUK KELEPÇE 2X105	1000	ad.	0.013
062 129 010102	EA.02.102 BONCUK KELEPÇE 3.5X165	500	ad.	0.030
062 129 025100	EB.02.202 KABLO BAĞI 2.5X100	250	ad.	0.009
062 129 025140	EB.12.212 KABLO BAĞI 2.5X140	100	ad.	0.016
062 129 025200	EB.13.213 KABLO BAĞI 2.5X200	100	ad.	0.026
062 129 036150	EB.03.203 KABLO BAĞI 3.6X150	100	ad.	0.026
062 129 036205	EB.04.204 KABLO BAĞI 3.6X205	100	ad.	0.034
062 129 036250	EB.09.209 KABLO BAĞI 3.6X250	100	ad.	0.047
062 129 036300	EB.10.210 KABLO BAĞI 3.6X300	100	ad.	0.057
062 129 036370	EB.11.211 KABLO BAĞI 3.6X370	100	ad.	0.070
062 129 048200	EB.14.214 KABLO BAĞI 4.8X200	100	ad.	0.049
062 129 048250	EB.06.206 KABLO BAĞI 4.8X250	100	ad.	0.063
062 129 048300	EB.05.205 KABLO BAĞI 4.8X300	100	ad.	0.075
062 129 048400	EB.16.216 KABLO BAĞI 4.8X400	100	ad.	0.092
062 129 008250	EB.07.207 KABLO BAĞI 8X250	100	ad.	0.123
062 129 008300	EB.18.218 KABLO BAĞI 8X300	100	ad.	0.137
062 129 008380	EB.19.219 KABLO BAĞI 8X380	100	ad.	0.166
062 129 008550	EB.15.215 KABLO BAĞI 8X550	100	ad.	0.264
062 129 009762	EB.17.217 KABLO BAĞI 9X762	100	ad.	0.502
062 129 010205	PV.40.205 DELİKLİ KABLO BAĞI 4X205	100	ad.	0.067
062 129 107365	EF.01.801 TOKALI KABLO BAĞI 7X365	250	ad.	0.185

KROŞE VE KLİPSLER				
062 129 132020	EK.01.1001 YAPIŞKANLI KROŞE 20X20	100	ad.	0.079
062 129 132828	EK.03.1003 YAPIŞKANLI KROŞE 28X28	100	ad.	0.119
062 129 131316	EK.16.1016 YAPIŞKANLI KLİPS 13X16	100	ad.	0.092
062 129 132525	EK.05.1005 YAPIŞKANLI KLİPS 25X25	100	ad.	0.162
062 129 191325	EK.19.1019 YAPIŞKANLI KLİPS 13X25	100	ad.	0.125
062 129 142525	EK.07.1007 YAPIŞKANLI KLİPS 25X25	100	ad.	0.176
062 129 151017	EK.06.1006 VİDALI KROŞE 10X17	250	ad.	0.052
062 129 151251	EK.12.1012 VİDALI KROŞE 12,5X19	250	ad.	0.044
062 129 151723	EK.02.1002 VİDALI KROŞE 17X23	250	ad.	0.063
062 129 151530	EK.13.1013 VİDALI KROŞE 15X30	100	ad.	0.073
062 129 161004	EK.04.1004 DÜBELLİ KROŞE 6 DELİK İÇİN	500	ad.	0.066
062 129 201008	EK.08.1008 KART TUTUCU 4,5 DELİK İÇİN	500	ad.	0.079
062 129 171009	EK.09.1009 DUVAR KROŞESİ 6 DELİK İÇİN	250	ad.	0.059
062 129 171048	EK.10.1010 DÜBELLİ KABLO TUTUCU Q4,8 DELİK İÇİN	250	ad.	0.063
033 129 100008	KANAL KROŞESİ 8 DELİK İÇİN	250	ad.	0.084
062 129 171011	EK.11.1011 KANAL KROŞESİ 6 DELİK İÇİN	250	ad.	0.053
062 129 181041	EK.41.1041 PLASTİK KAPAK DIŞ ÇAP: 14	500	ad.	0.050
062 129 181042	EK.42.1042 PLASTİK PUL DELİK ÇAPI:5,2	500	ad.	0.050

ETİKETLER				
062 129 111030	ET.01.901 KABLO BAĞI ETİKETİ 10X30	100	ad.	0.172
062 129 111035	ET.07.907 KABLO BAĞI ETİKETİ 10X35	100	ad.	0.211
062 129 112045	ET.06.906 KABLO BAĞI ETİKETİ 20X45	100	ad.	0.290
062 129 121530	ET.02.902 YAPIŞKANLI PANO ETİKETİ 15X30	100	ad.	0.271
062 129 121750	ET.03.903 YAPIŞKANLI PANO ETİKETİ 17X50	50	ad.	0.389
062 129 122035	ET.05.905 YAPIŞKANLI PANO ETİKETİ 20X35	50	ad.	0.449
062 129 122075	ET.04.904 YAPIŞKANLI PANO ETİKETİ 20X75	25	ad.	0.528

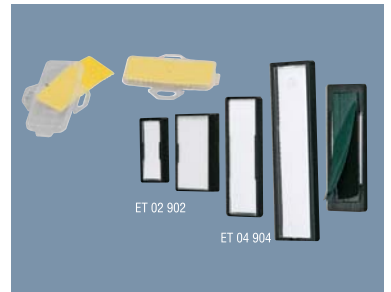
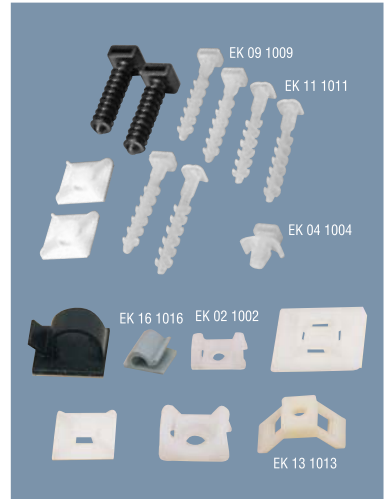
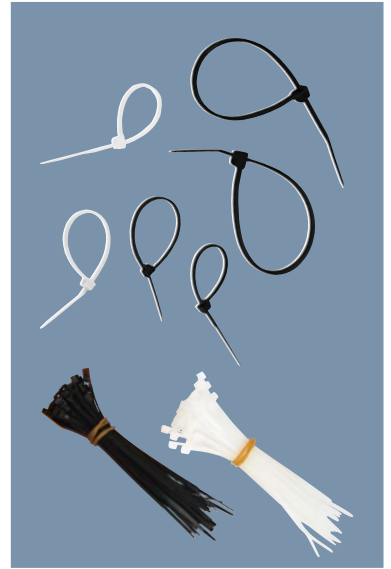
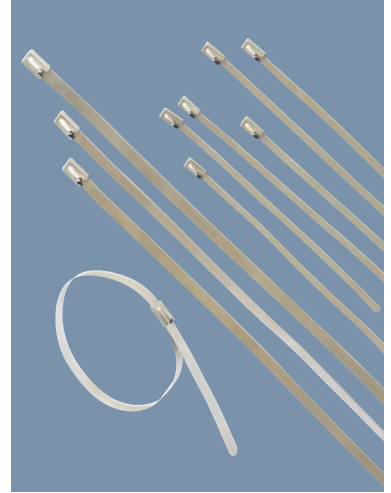

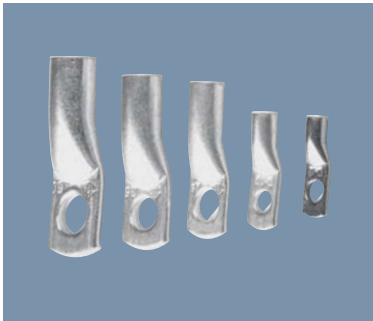
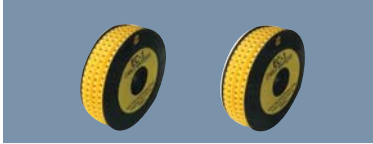
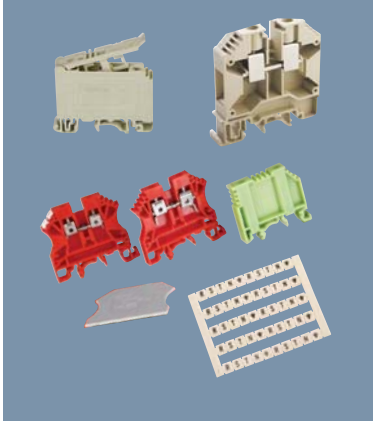

Ürün Kodu	Açıklama / Stok Cinsi	Ambalaj (Kutulu)	Ambalaj Birimi	TL
RAY KLEMENSLER				
010 094 000025	2.5 MM RAY KLEMENSİ	100	ad.	0.650
010 094 000004	4 MM RAY KLEMENSİ	100	ad.	0.825
010 094 000006	6 MM RAY KLEMENSİ	100	ad.	1.250
010 094 000010	10 MM RAY KLEMENSİ	100	ad.	1.625
010 094 000016	16 MM RAY KLEMENSİ	30	ad.	2.250
010 094 000035	35 MM RAY KLEMENSİ	20	ad.	4.100
010 094 010001	KLEMENS DURDURUCU	100	ad.	0.575
010 094 010002	NİHAYET PLAKASI	100	ad.	0.500
010 094 010006	YAZILI DEKAFİX (KUTU FİYATI)	500	ad.	24.500
010 094 010007	YAZISIZ DEKAFİX (KUTU FİYATI)	500	ad.	18.750
010 094 010003	2,5/4 MM TOPRAKLAMALI RAY KLEMENSİ	100	ad.	3.400
010 094 010004	6/10 MM TOPRAKLAMALI RAY KLEMENSİ	100	ad.	4.500
010 094 010005	16/35 MM TOPRAKLAMALI RAY KLEMENSİ	50	ad.	6.500
EC TİP KABLO KODLAMA SİSTEMLERİ (RAKAM)				
888 094 270501	EC-0 0,50-1,50 MM KABLolar İÇİN YUVARLAK Q2,0-3,0MM	1	ad.	3.000 USD.
888 094 271506	EC-1 1,50-6,00 MM KABLolar İÇİN YUVARLAK Q3,0-5,2MM	1	ad.	3.000 USD.
888 094 270416	EC-2 4-16 MM KABLolar İÇİN YUVARLAK Q3,6-7,4MM	1	ad.	3.000 USD.
888 094 271025	EC-3 10-25 MM KABLolar İÇİN YUVARLAK Q5,2-10MM	1	ad.	3.000 USD.
RAYLAR-TOPRAKLAMA ÇUBUKLARI VE BARALAR				
014 094 020001	RAY TAŞIYICISI (ALUMİNYUM)	75	ad.	1.200
001 025 020100 00 00	KLEMENS RAYI(1M)	25	mt.	4.485
001 025 000100 00 00	W OTOMAT RAYI(1M)	50	mt.	3.513
001 025 000033 00 00	W OTOMAT RAYI(33CM)	50	ad.	1.047
001 025 000099 99 00	W OTOMAT RAYI(ÖZEL BOY)	50	ad.	3.510
001 025 900100 00 00	W OTOMAT RAYI(DELİKLİ)(1M)	50	mt.	3.000
034 025 040001	TOPRAKLAMA BARASI 1 M.	10	mt.	26.500
091 025 010001	TOPRAKLAMA ÇUBUĞU 1 M. (PİYASA)	25	ad.	5.000
034 025 040004	TRİF. MÜŞTEREK BARA İĞNE UÇLU	25	ad.	29.250
034 025 040002	MON.MÜŞTEREK BARA İĞNE UÇLU	10	ad.	23.400
MİNİ BOY MESNET İZOLATÖRLERİ A.G. (1KV)				
049 123 010001	BMI-M 5/2C MİNİ İZOLATÖR	150	ad.	0.750
049 123 010002	BMI-M 5/1C+1S MİNİ İZOLATÖR	150	ad.	0.975
049 123 010003	BMI-M 5/2S MİNİ İZOLATÖR	15	ad.	1.150
MİNİ BOY KONİK MESNET İZOLATÖRLERİ A.G. (1KV)				
049 123 010004	BMI-M 6/2C MİNİ KONİK İZOLATÖR	50	ad.	1.100
049 123 010005	BMI-M 6/1C+1S MİNİ KONİK İZOLATÖR	50	ad.	1.250
049 123 010006	BMI-M 6/2S MİNİ KONİK İZOLATÖR	50	ad.	1.375
ORTA BOY KONİK MESNET İZOLATÖRLERİ A.G. (1KV)				
049 123 020001	BMI-M 6/2C ORTA KONİK İZOLATÖR	50	ad.	1.200
049 123 020002	BMI-M 6/1C+1S ORTA KONİK İZOLATÖR	50	ad.	1.375
049 123 020003	BMI-M 6/2S ORTA KONİK İZOLATÖR	50	ad.	1.500
BÜYÜK BOY MESNET İZOLATÖRLERİ A.G. (1KV)				
049 123 030001	BMI-M 8/2C BÜYÜK BOY KONİK İZOLATÖR	25	ad.	1.850
049 123 030002	BMI-M 8/1C+1S BÜYÜK BOY KONİK İZOLATÖR	25	ad.	2.175
049 123 030003	BMI-M 8/2S BÜYÜK BOY KONİK İZOLATÖR	25	ad.	2.375
049 123 030004	BMI-M 10/2C BÜYÜK BOY KONİK İZOLATÖR	25	ad.	2.450
049 123 030005	BMI-M 10/1C+1S BÜYÜK BOY KONİK İZOLATÖR	25	ad.	2.850
049 123 030006	BMI-M 10/2S BÜYÜK BOY KONİK İZOLATÖR	25	ad.	2.875
049 123 050001	BMS (M8-M10) BARA TUTUCU	100	ad.	2.200
TARAK İZOLATÖRLER				
049 123 040001	3X1 F TARAK İZOLATÖR	1	ad.	3.750
049 123 040002	3X2 F TARAK İZOLATÖR	1	ad.	4.700
049 123 040003	3X1 F+N TARAK İZOLATÖR	1	ad.	4.900
049 123 040005	3X2 F+N TARAK İZOLATÖR	1	ad.	5.425
SIKMALI TİP KABLO PAPUÇLARI (EKO SERİSİ)				
123 037 000006	6 MM2 SIKMALI TİP KABLO PAPUCU (EKO SERİSİ)	1000	ad.	0.314
123 037 001230	10 MM2 SIKMALI TİP KABLO PAPUCU (EKO SERİSİ)	800	ad.	0.381
123 037 001236	16 MM2 SIKMALI TİP KABLO PAPUCU (EKO SERİSİ)	500	ad.	0.538
123 037 000025	25 MM2 SIKMALI TİP KABLO PAPUCU (EKO SERİSİ)	350	ad.	0.636
123 037 000035	35 MM2 SIKMALI TİP KABLO PAPUCU (EKO SERİSİ)	200	ad.	0.914
123 037 000050	50 MM2 SIKMALI TİP KABLO PAPUCU (EKO SERİSİ)	150	ad.	1.716
123 037 000070	70 MM2 SIKMALI TİP KABLO PAPUCU (EKO SERİSİ)	100	ad.	2.255
123 037 000095	95 MM2 SIKMALI TİP KABLO PAPUCU (EKO SERİSİ)	70	ad.	2.695
123 037 000120	120 MM2 SIKMALI TİP KABLO PAPUCU(EKO SERİSİ)	50	ad.	3.300
123 037 000150	150 MM2 SIKMALI TİP KABLO PAPUCU(EKO SERİSİ)	40	ad.	5.280
123 037 000185	185 MM2 SIKMALI TİP KABLO PAPUCU(EKO SERİSİ)	30	ad.	6.650
123 037 000240	240 MM2 SIKMALI TİP KABLO PAPUCU(EKO SERİSİ)	24	ad.	9.570

Ürün Kodu	Açıklama / Stok Cinsi	Ambalaj (Kutulu)	Ambalaj Birimi	TL
SIKMALI TİP KABLO PAPUÇLARI (MEKS SERİSİ)				
888 037 200006	6 MM2 SIKMALI TİP KABLO PAPUCU (MEKS SERİSİ)	1000	ad.	0.345
888 037 200010	10 MM2 SIKMALI TİP KABLO PAPUCU (MEKS SERİSİ)	800	ad.	0.419
888 037 200016	16 MM2 SIKMALI TİP KABLO PAPUCU (MEKS SERİSİ)	500	ad.	0.591
888 037 200025	25 MM2 SIKMALI TİP KABLO PAPUCU (MEKS SERİSİ)	350	ad.	0.700
888 037 200035	35 MM2 SIKMALI TİP KABLO PAPUCU (MEKS SERİSİ)	200	ad.	1.169
888 037 200050	50 MM2 SIKMALI TİP KABLO PAPUCU (MEKS SERİSİ)	150	ad.	2.264
888 037 200070	70 MM2 SIKMALI TİP KABLO PAPUCU (MEKS SERİSİ)	100	ad.	3.017
888 037 200095	95 MM2 SIKMALI TİP KABLO PAPUCU (MEKS SERİSİ)	70	ad.	4.463
888 037 200120	120 MM2 SIKMALI TİP KABLO PAPUCU (MEKS SERİSİ)	50	ad.	5.650
888 037 200150	150 MM2 SIKMALI TİP KABLO PAPUCU (MEKS SERİSİ)	40	ad.	7.489
888 037 200185	185 MM2 SIKMALI TİP KABLO PAPUCU (MEKS SERİSİ)	30	ad.	11.555
888 037 200240	240 MM2 SIKMALI TİP KABLO PAPUCU (MEKS SERİSİ)	24	ad.	13.019



UZUN VE KALIN TİP SIKMALI KABLO EK MUFLARI				
123 037 300006	6 MM2 UZUN VE KALIN TİP SIKMALI EK MUFU	1000	ad.	0.322
123 037 300010	10 MM2 UZUN VE KALIN TİP SIKMALI EK MUFU	800	ad.	0.391
123 037 300016	16 MM2 UZUN VE KALIN TİP SIKMALI EK MUFU	500	ad.	0.552
123 037 300025	25MM2 UZUN VE KALIN TİP SIKMALI EK MUFU	350	ad.	0.653
123 037 300035	35 MM2 UZUN VE KALIN TİP SIKMALI EK MUFU	200	ad.	0.938
123 037 300050	50 MM2 UZUN VE KALIN TİP SIKMALI EK MUFU	150	ad.	1.313
123 037 300070	70 MM2 UZUN VE KALIN TİP SIKMALI EK MUFU	100	ad.	1.635
123 037 300095	95 MM2 UZUN VE KALIN TİP SIKMALI EK MUFU	70	ad.	2.217
123 037 300120	120 MM2 UZUN VE KALIN TİP SIKMALI EK MUFU	50	ad.	2.866
123 037 300150	150 MM2 UZUN VE KALIN TİP SIKMALI EK MUFU	40	ad.	4.467
123 037 300185	185 MM2 UZUN VE KALIN TİP SIKMALI EK MUFU	30	ad.	5.541
123 037 300240	240 MM2 UZUN VE KALIN TİP SIKMALI EK MUFU	24	ad.	6.817

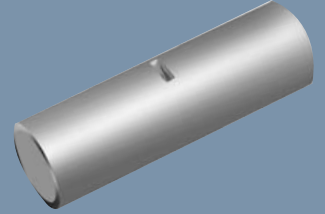

İZOLELİ TEK GİRİŞLİ YÜKSÜK				
014 100 010508	ITY-0508 İZO.TEK GİRİŞ. YÜKSÜK 0,50 MM	500	ad.	0.013 USD.
014 100 017508	ITY-7508 İZO.TEK GİRİŞ. YÜKSÜK 0,75 MM	500	ad.	0.013 USD.
014 100 011008	ITY-1008 İZO.TEK GİRİŞ. YÜKSÜK 1,00 MM	500	ad.	0.013 USD.
014 100 011508	ITY-1508 İZO.TEK GİRİŞ. YÜKSÜK 1,50 MM	500	ad.	0.013 USD.
014 100 012508	ITY-2508 İZO.TEK GİRİŞ. YÜKSÜK 2,50 MM	500	ad.	0.017 USD.
014 100 014009	ITY-4009 İZO.TEK GİRİŞ. YÜKSÜK 4,00 MM	250	ad.	0.028 USD.
014 100 016012	ITY-6012 İZO.TEK GİRİŞ. YÜKSÜK 6,00 MM	250	ad.	0.038 USD.
014 100 011012	ITY-1012 İZO.TEK GİRİŞ. YÜKSÜK 10,00 MM	100	ad.	0.050 USD.
014 100 011612	ITY-1612 İZO.TEK GİRİŞ. YÜKSÜK 16,00 MM	100	ad.	0.075 USD.
014 100 012516	ITY-2516 İZO.TEK GİRİŞ. YÜKSÜK 25,00 MM	50	ad.	0.146 USD.
014 100 013516	ITY-3516 İZO.TEK GİRİŞ. YÜKSÜK 35,00 MM	40	ad.	0.196 USD.
014 100 015020	ITY-5020 İZO.TEK GİRİŞ. YÜKSÜK 50,00 MM	20	ad.	0.284 USD.



İZOLELİ ÇİFT GİRİŞLİ YÜKSÜK				
014 100 020508	ICY-0508 İZO.ÇİFT GİRİŞ. YÜKSÜK 2X0,5 MM	500	ad.	0.029 USD.
014 100 027508	ICY-7508 İZO.ÇİFT GİRİŞ. YÜKSÜK 2X0,75MM	500	ad.	0.029 USD.
014 100 021008	ICY-1008 İZO.ÇİFT GİRİŞ. YÜKSÜK 2X1 MM	500	ad.	0.029 USD.
014 100 021508	ICY-1508 İZO.ÇİFT GİRİŞ. YÜKSÜK 2X1,5 MM	500	ad.	0.030 USD.
014 100 022510	ICY-2510 İZO.ÇİFT GİRİŞ. YÜKSÜK 2X2,5 MM	250	ad.	0.036 USD.
014 100 024012	ICY-4012 İZO.ÇİFT GİRİŞ. YÜKSÜK 2X4 MM	100	ad.	0.105 USD.
014 100 026014	ICY-6014 İZO.ÇİFT GİRİŞ. YÜKSÜK 2X6 MM	100	ad.	0.111 USD.



İZOLELİ YUVARLAK TİP PAPUÇ				
014 100 030154	IYP-1,5-4 İZO.YUV.TİP PAP. 0,5-1,5MM(M4)	200	ad.	0.036 USD.
014 100 030155	IYP-1,5-5 İZO.YUV.TİP PAP. 0,5-1,5MM(M5)	200	ad.	0.041 USD.
014 100 030156	IYP-1,5-6 İZO.YUV.TİP PAP. 0,5-1,5MM(M6)	200	ad.	0.052 USD.
014 100 030158	IYP-1,5-8 İZO.YUV.TİP PAP. 0,5-1,5MM(M8)	200	ad.	0.057 USD.
014 100 030254	IYP-2,5-4 İZO.YUV.TİP PAP. 1,5-2,5MM(M4)	200	ad.	0.042 USD.
014 100 030255	IYP-2,5-5 İZO.YUV.TİP PAP. 1,5-2,5MM(M5)	200	ad.	0.042 USD.
014 100 030256	IYP-2,5-6 İZO.YUV.TİP PAP. 1,5-2,5MM(M6)	200	ad.	0.052 USD.
014 100 030258	IYP-2,5-8 İZO.YUV.TİP PAP. 1,5-2,5MM(M8)	200	ad.	0.055 USD.
014 100 036004	IYP-6-4 İZO.YUV.TİP PAP. 4-6MM(M4)	100	ad.	0.071 USD.
014 100 036005	IYP-6-5 İZO.YUV.TİP PAP. 4-6 MM(M5)	100	ad.	0.072 USD.
014 100 036006	IYP-6-6 İZO.YUV.TİP PAP. 4-6MM(M6)	100	ad.	0.075 USD.
014 100 036008	IYP-6-8 İZO.YUV.TİP PAP. 4-6MM(M8)	100	ad.	0.098 USD.



İZOLELİ ÇATAL TİP PAPUÇ				
014 100 040154	ICP-1,5-4 İZO.ÇTL.TİP PAP. 0,5-1,5MM(M4)	200	ad.	0.039 USD.
014 100 040155	ICP-1,5-5 İZO.ÇTL.TİP PAP. 0,5-1,5MM(M5)	200	ad.	0.045 USD.
014 100 040156	ICP-1,5-6 İZO.ÇTL.TİP PAP. 0,5-1,5MM(M6)	200	ad.	0.052 USD.
014 100 040254	ICP-2,5-4 İZO.ÇTL.TİP PAP. 0,5-1,5MM(M4)	200	ad.	0.041 USD.
014 100 040255	ICP-2,5-5 İZO.ÇTL.TİP PAP. 0,5-1,5MM(M5)	200	ad.	0.045 USD.
014 100 040256	ICP-2,5-6 İZO.ÇTL.TİP PAP. 0,5-1,5MM(M6)	200	ad.	0.056 USD.
014 100 046004	ICP-6-4 İZO.ÇTL.TİP PAP. 4-6 MM(M4)	100	ad.	0.066 USD.
014 100 046005	ICP-6-5 İZO.ÇTL.TİP PAP. 4-6 MM(M5)	100	ad.	0.073 USD.
014 100 046006	ICP-6-6 İZO.ÇTL.TİP PAP. 4-6 MM(M6)	100	ad.	0.093 USD.



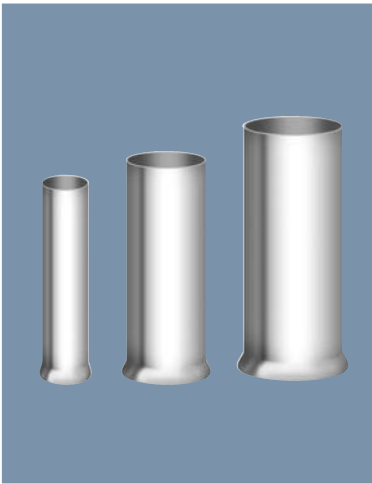

Ürün Kodu	Açıklama / Stok Cinsi	Ambalaj (Kutulu)	Ambalaj Birimi	TL
İZOLELİ İĞNE TİP TERMİNAL				
014 100 050015	IIT-1,5 İZOLELİ İĞNE TİP TERM.0,5-1,5MM	200	ad.	0.043 USD.
014 100 050025	IIT-2,5 İZOLELİ İĞNE TİP TERM.1,5-2,5MM	200	ad.	0.048 USD.
014 100 050040	IIT-4 İZOLELİ İĞNE TİP TERM.4-6MM	100	ad.	0.093 USD.
İZOLELİ EK MUF				
014 100 070015	IEM-1,5 İZOLELİ EK MUF 0,5-1,5 MM	100	ad.	0.080 USD.
014 100 070025	IEM-2,5 İZOLELİ EK MUF 1,5-2,5 MM	100	ad.	0.090 USD.
014 100 070040	IEM-4 İZOLELİ EK MUF 4-6 MM	100	ad.	0.083 USD.
İZOLELİ FASTON ERKEK TERMİNAL				
014 100 060015	IFE-1,5 İZO. FASTON ERK. TERM. 1,5 MM	200	ad.	0.083 USD.
014 100 060025	IFE-2,5 İZO. FASTON ERK. TERM. 2,5 MM	200	ad.	0.083 USD.
014 100 060040	IFE-4 İZO. FASTON ERK. TERM. 4 MM	100	ad.	0.121 USD.
İZOLELİ FASTON DIŞI TERMİNAL				
014 100 080510	IDT-0,5-1 İZO. FASTON DIŞI TERM. 0,5-1MM	200	ad.	0.083 USD.
014 100 081525	IDT-1,5-2,5 İZO.FASTON DIŞI TERM. 1,5-2,5MM	200	ad.	0.083 USD.
014 100 084060	IDT-4-6 İZO. FASTON DIŞI TERM. 4-6 MM	100	ad.	0.121 USD.
TAM İZOLELİ DIŞI TERMİNAL				
014 100 090510	TDT-0,5-1 TAM İZO.DİŞİ TERM. 0,5-1 MM	200	ad.	0.083 USD.
014 100 091525	TDT-1,5-2,5 TAM İZO.DİŞİ TERM.1,5-2,5 MM	200	ad.	0.083 USD.
014 100 094060	TDT-4-6 TAM İZO.DİŞİ TERM. 4-6 MM	100	ad.	0.128 USD.
YUVARLAK DIŞI TERMİNAL				
014 100 100510	YDT-0,5-1 YUV. DIŞI TERM. 0,5-1 MM	200	ad.	0.083 USD.
014 100 101525	YDT-1,5-2,5 YUV. DIŞI TERM. 1,5-2,5 MM	200	ad.	0.083 USD.
014 100 104060	YDT-4-6 YUV. DIŞI TERM. 4-6 MM	100	ad.	0.128 USD.
YUVARLAK ERKEK TERMİNAL				
014 100 110510	YET-0,5-1 YUV. ERKEK TERM. 0,5-1 MM	200	ad.	0.056 USD.
014 100 111525	YET-1,5-2,5 YUV. ERKEK TERM.1,5-2,5 MM	200	ad.	0.060 USD.
014 100 114060	YET-4-6 YUV. ERKEK TERM. 4-6 MM	100	ad.	0.105 USD.
İZOLESİZ KABLO YÜKSÜKLERİ				
065 100 135060	TKY-0,50-6 İZOLESİZ KABLO YÜKSÜĞÜ	1000	ad.	0.011 USD.
065 100 135010	TKY-0,50-10 İZOLESİZ KABLO YÜKSÜĞÜ	1000	ad.	0.011 USD.
065 100 130751	TKY-0,75-10 İZOLESİZ KABLO YÜKSÜĞÜ	1000	ad.	0.011 USD.
065 100 131006	TKY-1-6 İZOLESİZ KABLO YÜKSÜĞÜ	1000	ad.	0.011 USD.
065 100 130110	TKY-1-10 İZOLESİZ KABLO YÜKSÜĞÜ	1000	ad.	0.011 USD.
065 100 130157	TKY-1,5-7 İZOLESİZ KABLO YÜKSÜĞÜ	1000	ad.	0.011 USD.
065 100 130151	TKY-1,5-10 İZOLESİZ KABLO YÜKSÜĞÜ	1000	ad.	0.011 USD.
065 100 130258	TKY-2,5-8 İZOLESİZ KABLO YÜKSÜĞÜ	1000	ad.	0.013 USD.
065 100 132512	TKY-2,5-12 İZOLESİZ KABLO YÜKSÜĞÜ	1000	ad.	0.013 USD.
065 100 130412	TKY-4-12 İZOLESİZ KABLO YÜKSÜĞÜ	500	ad.	0.020 USD.
065 100 130612	TKY-6-12 İZOLESİZ KABLO YÜKSÜĞÜ	500	ad.	0.023 USD.
065 100 130010	TKY-10 İZOLESİZ KABLO YÜKSÜĞÜ	250	ad.	0.033 USD.
065 100 130016	TKY-16 İZOLESİZ KABLO YÜKSÜĞÜ	100	ad.	0.042 USD.
065 100 130025	TKY-25 İZOLESİZ KABLO YÜKSÜĞÜ	100	ad.	0.093 USD.
065 100 130035	TKY-35 İZOLESİZ KABLO YÜKSÜĞÜ	100	ad.	0.133 USD.
065 100 130050	TKY-50 İZOLESİZ KABLO YÜKSÜĞÜ	50	ad.	0.269 USD.
FASTON TİP TERMİNALLER İZOLESİZ				
065 100 140003	TSF-1-D 6,3 FASTON TİP TERMİNAL	200	ad.	0.025 USD.
065 100 140002	TSF-1-D MİNİ 6,8 FASTON TİP TERMİNAL	200	ad.	0.020 USD.
065 100 140001	TSF-1-D GÜMÜŞ FASTON TİP TERMİNAL	200	ad.	0.030 USD.
065 100 140004	TSF-1-E FASTON TİP TERMİNAL	200	ad.	0.025 USD.
İZOLELİ KABLO UCU SIKMA PENSELERİ				
014 101 010002	YSP-6 0,50-6 YÜKSÜK SIKMA PENSESİ	1	ad.	40.000 USD.
014 101 010003	İPS-6 0,50-6 YÜKSÜK SIKMA PENSESİ	1	ad.	30.800 USD.
014 101 010004	YSP-6W 0,50-6 YÜKSÜK SIKMA PENSESİ	1	ad.	57.960 USD.
014 101 010006	KP-6 KABLO SIYIRMA PENSESİ	1	ad.	27.860 USD.
014 101 010007	SKP-6/50 SKP SIKMA PENSESİ	1	ad.	103.040 USD.
014 101 010008	SKP-10/120 SKP SIKMA PENSESİ	1	ad.	157.780 USD.

MUTLUSAN SİNYAL VE KUMANDA BUTONLARI



Ürün Kodu : 010 090 010001
 Ürün Adı : 10 mm KABLolu SİNYAL ARM.
 Ambalaj Ad. : 100
 Fiyat : 1.000 TL

Renk :



Ürün Kodu : 010 090 010002
 Ürün Adı : BA9S DUYLU LEDLİ 22 mm SİN.ARMATÜRÜ 220V

Ambalaj Ad. : 20
 Fiyat : 2.875 TL



Ürün Kodu : 010 090 010005
 Ürün Adı : 14 mm SİNYAL ARM. 12V
 Ambalaj Ad. : 50
 Fiyat : 1.250 TL

Renk :



Ürün Kodu : 010 090 010003
 Ürün Adı : BA9S DUYLU NEON 22 mm SİN.ARMATÜRÜ 220V

Ambalaj Ad. : 20
 Fiyat : 1.575 TL



Ürün Kodu : 010 090 010006
 Ürün Adı : 14 mm SİNYAL ARM. 24V
 Ambalaj Ad. : 50
 Fiyat : 1.250 TL

Renk :



Ürün Kodu : 010 090 040001
 Ürün Adı : YAYLI START BUTONU
 Ambalaj Ad. : 20
 Fiyat : 3.725 TL

Renk :



Ürün Kodu : 010 090 010007
 Ürün Adı : 14 mm SİNYAL ARM. 220V
 Ambalaj Ad. : 50
 Fiyat : 1.000 TL

Renk :



Ürün Kodu : 010 090 040002
 Ürün Adı : YAYLI STOP BUTONU
 Ambalaj Ad. : 20
 Fiyat : 3.725 TL

Renk :



Ürün Kodu : 010 090 010008
 Ürün Adı : 22 mm SİNYAL ARM. 12V
 Ambalaj Ad. : 24
 Fiyat : 1.788 TL

Renk :



Ürün Kodu : 010 090 050004
 Ürün Adı : BA9S NEON AMPÜLLÜ YAYLI İŞIKLI STR.BUT.
 Ambalaj Ad. : 20
 Fiyat : 6.150 TL



Ürün Kodu : 010 090 010009
 Ürün Adı : 22 mm SİNYAL ARM. 24V
 Ambalaj Ad. : 24
 Fiyat : 1.788 TL

Renk :



Ürün Kodu : 010 090 050005
 Ürün Adı : BA9S NEON AMPÜLLÜ YAYLI İŞIKLI STP.BUT.
 Ambalaj Ad. : 20
 Fiyat : 6.150 TL

Renk :



Ürün Kodu : 010 090 010010
 Ürün Adı : 22 mm SİNYAL ARM. 220V
 Ambalaj Ad. : 24
 Fiyat : 1.538 TL

Renk :



Ürün Kodu : 010 090 050003
 Ürün Adı : BA9S LEDLİ YAYLI İŞIKLI START BUTONU
 Ambalaj Ad. : 20
 Fiyat : 7.925 TL

Renk :

MUTLUSAN SİNYAL VE KUMANDA BUTONLARI



Ürün Kodu : 010 090 050005
 Ürün Adı : BA9S LEDLİ YAYLI IŞIKLI
 STOP BUTONU
 Ambalaj Ad. : 20
 Fiyat : 7.925 TL

Renk : ■



Ürün Kodu : 010 090 020003
 Ürün Adı : ESKİ TİP STOP BUTONU
 TEK KONTAK
 Ambalaj Ad. : 20
 Fiyat : 3.300 TL

Renk : ■



Ürün Kodu : 010 090 040005
 Ürün Adı : YAYLI MANTAR KAFA
 BUTON STOP
 Ambalaj Ad. : 12
 Fiyat : 4.500 TL

Renk : ■



Ürün Kodu : 010 090 050001
 Ürün Adı : ACİL STOP BUTONU (30'LİK)
 Ambalaj Ad. : 12
 Fiyat : 6.500 TL

Renk : ■



Ürün Kodu : 010 090 040003
 Ürün Adı : YAYLI MANTAR KAFA
 BUTON START
 Ambalaj Ad. : 12
 Fiyat : 4.500 TL

Renk : ■ ■



Ürün Kodu : 010 090 050002
 Ürün Adı : ACİL STOP BUTONU (40'LİK)
 Ambalaj Ad. : 12
 Fiyat : 6.500 TL

Renk : ■



Ürün Kodu : 010 090 030003
 Ürün Adı : BA9S LEDLİ IŞIKLI SEÇİCİ
 BUTON 0-1
 Ambalaj Ad. : 12
 Fiyat : 8.850 TL

Renk : ■ ■



Ürün Kodu : 010 090 040007
 Ürün Adı : YAYLI İKİZ BUTON
 Ambalaj Ad. : 14
 Fiyat : 7.500 TL

Renk : ■ ■



Ürün Kodu : 010 090 030004
 Ürün Adı : BA9S LEDLİ IŞIKLI SEÇİCİ
 BUTON 11-0-1
 Ambalaj Ad. : 12
 Fiyat : 10.825 TL

Renk : ■



Ürün Kodu : 010 090 040006
 Ürün Adı : YAYLI IŞIKLI İKİZ BUTON
 Ambalaj Ad. : 14
 Fiyat : 9.625 TL

Renk : ■ ■



Ürün Kodu : 010 090 020002
 Ürün Adı : ESKİ TİP START-STOP BUTONU
 ÇİFT KONTAK
 Ambalaj Ad. : 20
 Fiyat : 4.125 TL

Renk : ■ ■ ■ ■ ■



Ürün Kodu : 010 090 030001
 Ürün Adı : SEÇİCİ BUTON 0-1
 Ambalaj Ad. : 12
 Fiyat : 4.525 TL

Renk : ■



Ürün Kodu : 010 090 020001
 Ürün Adı : ESKİ TİP START BUTONU
 TEK KONTAK
 Ambalaj Ad. : 20
 Fiyat : 3.300 TL

Renk : ■



Ürün Kodu : 010 090 030002
 Ürün Adı : SEÇİCİ BUTON 11-0-1
 Ambalaj Ad. : 12
 Fiyat : 6.500 TL

Renk : ■

MUTLUSAN SİNYAL VE KUMANDA BUTONLARI



Ürün Kodu : 010 090 030007
 Ürün Adı : SEÇİCİ BUTON 0-1 ANAHTARLI
 Ambalaj Ad. : 12
 Fiyat : 12.500 TL

Renk : ■



Ürün Kodu : 010 111 070004
 Ürün Adı : BUZZER 24 VOLT
 Ambalaj Ad. : 24
 Fiyat : 7.175 TL



Ürün Kodu : 010 090 030008
 Ürün Adı : SEÇİCİ BUTON 11-0-1 ANAHTARLI
 Ambalaj Ad. : 12
 Fiyat : 14.500 TL

Renk : ■



Ürün Kodu : 010 090 030005
 Ürün Adı : BA9S NEON AMPÜLLÜ IŞIKLI
 SEÇ.BUT. 0-1
 Ambalaj Ad. : 12
 Fiyat : 7.075 TL

Renk : ■



Ürün Kodu : 010 090 050007
 Ürün Adı : ANAHTARLI ACİL STOP
 BUTONU (40'LİK)
 Ambalaj Ad. : 12
 Fiyat : 12.500 TL

Renk : ■



Ürün Kodu : 010 090 030006
 Ürün Adı : BA9S NEON AMPÜLLÜ IŞIKLI
 SEÇ.BUT. 11-0-1
 Ambalaj Ad. : 12
 Fiyat : 9.075 TL

Renk : ■



Ürün Kodu : 010 091 020002
 Ürün Adı : YÖN İŞARETLİ START BUTONU
 22 mm SİNYAL ARM. 220V
 Ambalaj Ad. : 20
 Fiyat : 3.750 TL

Renk : □ ■ ■ ■ ■

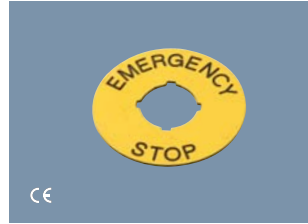

Ürün Kodu : 010 093 000003
 Ürün Adı : ACİL DURDURMA ETİKETİ
 Ambalaj Ad. : 50
 Fiyat : 2.000 TL

Renk : ■



Ürün Kodu : 010 111 070001
 Ürün Adı : BUZZER 220 VOLT LEDLİ
 Ambalaj Ad. : 24
 Fiyat : 9.050 TL

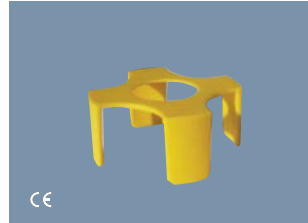

Ürün Kodu : 010 090 050008
 Ürün Adı : EMNİYET BASMA DÜĞMESİ
 MUHAFAZA
 Ambalaj Ad. : 50
 Fiyat : 0.875 TL



Ürün Kodu : 010 111 070002
 Ürün Adı : BUZZER 24 VOLT LEDLİ
 Ambalaj Ad. : 24
 Fiyat : 8.500 TL



Ürün Kodu : 010 093 000001
 Ürün Adı : SİLİKON TOZ KILIFI
 Ambalaj Ad. : 50
 Fiyat : 1.875 TL

Renk : □



Ürün Kodu : 010 111 070003
 Ürün Adı : BUZZER 220 VOLT
 Ambalaj Ad. : 24
 Fiyat : 7.900 TL



Ürün Kodu : 010 093 000002
 Ürün Adı : BUTON ETİKETİ
 Ambalaj Ad. : 50
 Fiyat : 0.500 TL

Renk : ■

MUTLUSAN SİNYAL VE KUMANDA BUTONLARI

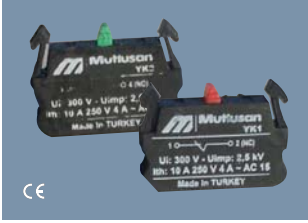

Ürün Kodu : 010 093 000004
 Ürün Adı : YEDEK KONTAK BLOK
 Ambalaj Ad. : 50
 Fiyat : 2.000 TL

Renk :



Ürün Kodu : 010 093 000005
 Ürün Adı : IŞIK SOKETİ
 Ambalaj Ad. : 20
 Fiyat : 1.800 TL

Renk :

EUROBOX ETANJ BUTON KUTULARI (YENİ MODEL)

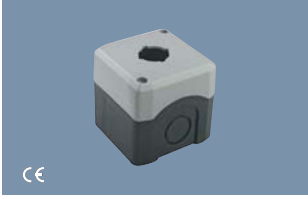

Ürün Kodu : 010 091 010001
 Ürün Adı : 1 Lİ ETANJ BUTON KUTUSU
 Ambalaj Ad. : 24
 Fiyat : 4.125 TL
 Renk :

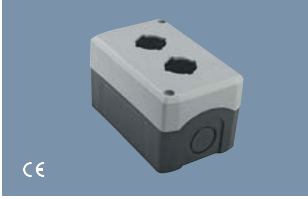

Ürün Kodu : 010 091 010002
 Ürün Adı : 2 Lİ ETANJ BUTON KUTUSU
 Ambalaj Ad. : 16
 Fiyat : 5.000 TL
 Renk :



Ürün Kodu : 010 091 010003
 Ürün Adı : 3 LÜ ETANJ BUTON KUTUSU
 Ambalaj Ad. : 8
 Fiyat : 6.875 TL
 Renk :

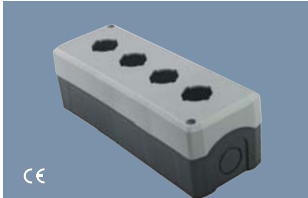

Ürün Kodu : 010 091 010004
 Ürün Adı : 4 LÜ ETANJ BUTON KUTUSU
 Ambalaj Ad. : 8
 Fiyat : 8.250 TL
 Renk :



Ürün Kodu : 010 090 050009
 Ürün Adı : TEKLİ ACİL STOPLU KUTU
 Ambalaj Ad. : 18
 Fiyat : 9.875 TL
 Renk :



Ürün Kodu : 010 091 020001
 Ürün Adı : ASANSÖR REVİZYON 4'LÜ KUTU
 Ambalaj Ad. : 6
 Fiyat : 32.500 TL
 Renk :

VİNÇ KUTULARI



Ürün Kodu : 010 092 000001
 Ürün Adı : İKİLİ VİNÇ KUTUSU (TEK HIZLI)
 Ambalaj Ad. : 1
 Fiyat : 32.500 TL



Ürün Kodu : 010 092 000002
 Ürün Adı : ÜÇLÜ VİNÇ KUTUSU (TEK HIZLI)
 Ambalaj Ad. : 1
 Fiyat : 39.000 TL



Ürün Kodu : 010 092 000003
 Ürün Adı : DÖRTLÜ VİNÇ KUTUSU (TEK HIZLI)
 Ambalaj Ad. : 1
 Fiyat : 50.000 TL



Ürün Kodu : 010 092 000004
 Ürün Adı : BEŞLİ VİNÇ KUTUSU (TEK HIZLI)
 Ambalaj Ad. : 1
 Fiyat : 56.500 TL



Ürün Kodu : 010 092 000005
 Ürün Adı : ALTILİ VİNÇ KUTUSU (TEK HIZLI)
 Ambalaj Ad. : 1
 Fiyat : 70.000 TL



Ürün Kodu : 010 092 000006
 Ürün Adı : YEDİLİ VİNÇ KUTUSU (TEK HIZLI)
 Ambalaj Ad. : 1
 Fiyat : 76.500 TL

MEKSTECH SERİSİ İTHAL SİNYAL VE BUTONLAR



Ürün Kodu : 888 090 070015
Ürün Adı : LAY4-BS542 MANTAR KAFA
 ÇEK-ÇEVİR
Ambalaj Ad. : 20
Fiyat : 4.698 USD.
Renk : ■



Ürün Kodu : 888 090 070004
Ürün Adı : LAY4-BC42 MANTAR
 KAFA KAYICI
Ambalaj Ad. : 20
Fiyat : 3.780 USD.
Renk : ■ ■



Ürün Kodu : 888 090 070011
Ürün Adı : LAY4-BS142 ANAHTARLI
 MANTAR KAFA
Ambalaj Ad. : 20
Fiyat : 6.588 USD.
Renk : ■

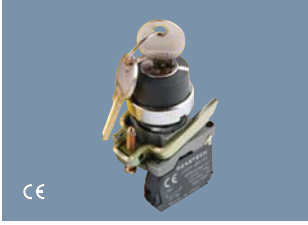

Ürün Kodu : 888 090 070033
Ürün Adı : LAY4-BG21 ANAHTARLI
 TEK TARAFLI KALICI
Ambalaj Ad. : 20
Fiyat : 4.968 USD.
Renk : ■



Ürün Kodu : 888 090 070034
Ürün Adı : LAY4-BG33 ANAHTARLI
 SAĞ+SOL KALICI
Ambalaj Ad. : 20
Fiyat : 6.048 USD.
Renk : ■

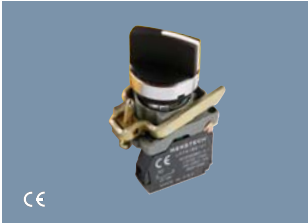

Ürün Kodu : 888 090 070001
Ürün Adı : LAY4-BD21 KS.MND.BUT.
 TEK TARAFLI KALICI
Ambalaj Ad. : 20
Fiyat : 3.186 USD.
Renk : ■



Ürün Kodu : 888 090 070048
Ürün Adı : LAY4-BD21 KS.MND.BUT.
 TEK TARAFLI KAYICI
Ambalaj Ad. : 20
Fiyat : 3.186 USD.
Renk : ■



Ürün Kodu : 888 090 070003
Ürün Adı : LAY4-BD33 KS.MND.BUT.
 SAĞ+SOL KALICI
Ambalaj Ad. : 20
Fiyat : 4.158 USD.
Renk : ■



Ürün Kodu : 888 090 070050
Ürün Adı : LAY4-BD33 KS.MND.BUT.
 SAĞ+SOL KAYICI
Ambalaj Ad. : 20
Fiyat : 4.158 USD.
Renk : ■



Ürün Kodu : 888 090 070029
Ürün Adı : LAY4-BJ33 KS.MND.BUT.
 SAĞ-SOL KLC.İKİ KONT.
Ambalaj Ad. : 20
Fiyat : 4.158 USD.
Renk : ■

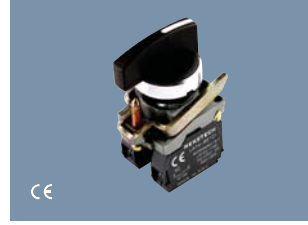

Ürün Kodu : 888 090 070016
Ürün Adı : LAY4-BJ21 UZ.MND.BUT.
 TEK TARAFLI KALICI
Ambalaj Ad. : 20
Fiyat : 3.186 USD.
Renk : ■



Ürün Kodu : 888 090 070059
Ürün Adı : LAY4-BJ21 UZ.MND.BUT.
 TEK TARAFLI KAYICI
Ambalaj Ad. : 20
Fiyat : 3.186 USD.
Renk : ■



Ürün Kodu : 888 090 070028
Ürün Adı : LAY4-BL8425 LEDLİ YAYLI
 İKİZ BUTON
Ambalaj Ad. : 20
Fiyat : 5.832 USD.
Renk : ■ ■

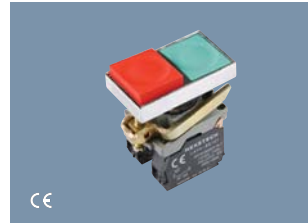

Ürün Kodu : 888 090 070027
Ürün Adı : LAY4-BL8325
 İKİZ BUTON
Ambalaj Ad. : 20
Fiyat : 6.318 USD.
Renk : ■ ■

MEKSTECH SERİSİ İTHAL SİNYAL VE BUTONLAR

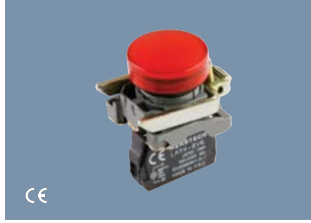

Ürün Kodu : 888 090 070002
 Ürün Adı : LAY4-BV64 SİNYAL LAMBALAR
 Ambalaj Ad. : 20
 Fiyat : 4.482 USD.

Renk :



Ürün Kodu : 888 090 070037
 Ürün Adı : LAY4-BP42 PLS.KILIFLI YAYLI STR.STP BUT.

Ambalaj Ad. : 20
 Fiyat : 3.186 USD.

Renk :



Ürün Kodu : 888 090 070020
 Ürün Adı : LAY4-BV3371 IŞIKLI YAYLI START BUTONLARI

Ambalaj Ad. : 20
 Fiyat : 6.642 USD.

Renk :

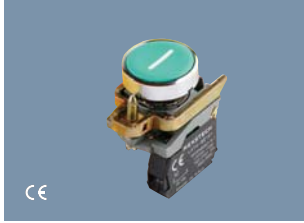

Ürün Kodu : 888 090 070017
 Ürün Adı : LAY4-BA3311 YAYLI İŞARETLİ START BUTONU

Ambalaj Ad. : 20
 Fiyat : 3.024 USD.

Renk :



Ürün Kodu : 888 090 070021
 Ürün Adı : LAY4-BV3472 LED'Lİ YAYLI START BUTONLARI

Ambalaj Ad. : 20
 Fiyat : 6.642 USD.

Renk :

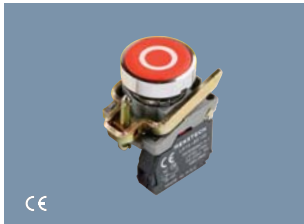

Ürün Kodu : 888 090 070022
 Ürün Adı : LAY4-BA3322 YAYLI İŞARETLİ STOP BUTONU

Ambalaj Ad. : 20
 Fiyat : 3.024 USD.

Renk :



Ürün Kodu : 888 090 070009
 Ürün Adı : LAY4-BE101 START KONTAK BLOĞU
 Ambalaj Ad. : 100
 Fiyat : 0.918 USD.

Renk :



Ürün Kodu : 888 090 070018
 Ürün Adı : LAY4-BA3341 YAYLI İŞARETLİ START BUTONU

Ambalaj Ad. : 20
 Fiyat : 3.024 USD.

Renk :



Ürün Kodu : 888 090 070010
 Ürün Adı : LAY4-BE102 STOP KONTAK BLOĞU
 Ambalaj Ad. : 100
 Fiyat : 0.918 USD.

Renk :



Ürün Kodu : 888 090 070032
 Ürün Adı : LAY4-EA4322 YAYLI STOP B.
 Ambalaj Ad. : 20
 Fiyat : 2.430 USD.

Renk :

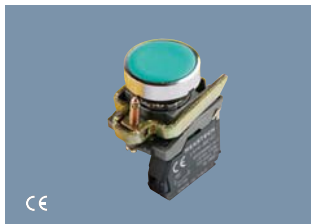

Ürün Kodu : 888 090 070076
 Ürün Adı : LAY4-BA31 YAYLI START BUTONU
 Ambalaj Ad. : 20
 Fiyat : 2.970 USD.

Renk :



Ürün Kodu : 888 090 070063
 Ürün Adı : LAY4-EA3351 YAYLI START B.
 Ambalaj Ad. : 20
 Fiyat : 2.430 USD.

Renk :



Ürün Kodu : 888 090 070014
 Ürün Adı : LAY4-BA42 YAYLI STOP BUTONU
 Ambalaj Ad. : 20
 Fiyat : 2.970 USD.

Renk :



Ürün Kodu : 888 090 070051
 Ürün Adı : LAY4-EC42 MANTAR Kafa Kayıcı
 Ambalaj Ad. : 20
 Fiyat : 3.402 USD.

Renk :

MEKSTECH SERİSİ İTHAL SİNYAL VE BUTONLAR



Ürün Kodu : 888 090 070058
Ürün Adı : LAY4-ES542 MANTAR KAFA
 ÇEK-ÇEVİR
Ambalaj Ad. : 20
Fiyat : 4.050 USD.

Renk : ■



Ürün Kodu : 888 090 070073
Ürün Adı : LAY4-ED33 KS.MND.BUT.
 SAĞ-SOL KALICI
Ambalaj Ad. : 20
Fiyat : 3.726 USD.

Renk : ■



Ürün Kodu : 888 090 070078
Ürün Adı : LAY4-ES142 MANTAR KAFA
 ANAHTARLI
Ambalaj Ad. : 20
Fiyat : 5.616 USD.

Renk : ■



Ürün Kodu : 888 090 070012
Ürün Adı : LAY4-ED21 KS.MND.BUT.
 TEK TARAF KAYICI
Ambalaj Ad. : 20
Fiyat : 2.808 USD.

Renk : ■ ■



Ürün Kodu : 888 090 070074
Ürün Adı : LAY4-EG21 ANAH. BUT. TEK
 TARAFLI KALICI
Ambalaj Ad. : 20
Fiyat : 4.050 USD.

Renk : ■



Ürün Kodu : 888 090 070072
Ürün Adı : LAY4-ED21 KS.MND.BUT.
 SAĞ-SOL KAYICI
Ambalaj Ad. : 20
Fiyat : 2.808 USD.

Renk : ■



Ürün Kodu : 888 090 070048
Ürün Adı : LAY4-EG21 ANAH. BUT. TEK
 TARAFLI KAYICI
Ambalaj Ad. : 20
Fiyat : 4.050 USD.

Renk : ■



Ürün Kodu : 888 090 070054
Ürün Adı : LAY4-EA31 YAYLI START
 BUTONU
Ambalaj Ad. : 20
Fiyat : 2.322 USD.

Renk : ■ ■ ■ ■ ■



Ürün Kodu : 888 090 070075
Ürün Adı : LAY4-EG33 ANAH. BUT.
 SAĞ-SOL KALICI
Ambalaj Ad. : 20
Fiyat : 4.968 USD.

Renk : ■



Ürün Kodu : 888 090 070055
Ürün Adı : LAY4-EA42 YAYLI STOP
 BUTONU
Ambalaj Ad. : 20
Fiyat : 2.322 USD.

Renk : ■

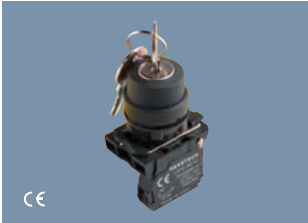

Ürün Kodu : 888 090 070071
Ürün Adı : LAY4-EG33 ANAHTARLI
 BUTON SAĞ-SOL KAYICI
Ambalaj Ad. : 20
Fiyat : 4.968 USD.

Renk : ■ ■ ■ ■



Ürün Kodu : 888 090 070061
Ürün Adı : LAY4-EA3311 YAYLI İŞARETLİ
 START BUTONU
Ambalaj Ad. : 20
Fiyat : 2.430 USD.

Renk : ■



Ürün Kodu : 888 090 070013
Ürün Adı : LAY4-ED33 KS.MND.BUT.
 TEK TARAF KALICI
Ambalaj Ad. : 20
Fiyat : 3.726 USD.

Renk : ■



Ürün Kodu : 888 090 070019
Ürün Adı : LAY4-EA3361 YAYLI İŞARETLİ
 START BUTONU
Ambalaj Ad. : 20
Fiyat : 2.430 USD.

Renk : ■

MEKSTECH SERİSİ İTHAL SİNYAL VE BUTONLAR



Ürün Kodu : 888 090 070062
 Ürün Adı : LAY4-EA3341 YAYLI İŞARETLİ
 START BUTONU
 Ambalaj Ad. : 20
 Fiyat : 2.430 USD.

Renk : L



Ürün Kodu : 888 090 070068
 Ürün Adı : LAY4-EL8325 YAYLI İKİZ
 BUTON
 Ambalaj Ad. : 20
 Fiyat : 4.644 USD.

Renk : R G



Ürün Kodu : 888 090 070063
 Ürün Adı : LAY4-EA3351 YAYLI İŞARETLİ
 START BUTONU
 Ambalaj Ad. : 20
 Fiyat : 2.430 USD.

Renk : S

AYAK PEDALLARI



Ürün Kodu : 084 132 000001
 Ürün Adı : AP-1 METAL PEDAL NO+NC
 1,5 MT.KAB.SİYAH
 Ambalaj Ad. : 1
 Fiyat : 5.000 USD.



Ürün Kodu : 888 090 070077
 Ürün Adı : LAY4-EV630 LED'Lİ SİNYAL
 LAMBALAR
 Ambalaj Ad. : 20
 Fiyat : 3.456 USD.

Renk : B Y K R



Ürün Kodu : 084 132 000002
 Ürün Adı : AP-3 DÖK.PEDAL NO+NC
 1,5 MT.KAB.GRİ-SARI
 Ambalaj Ad. : 1
 Fiyat : 8.475 USD.



Ürün Kodu : 888 090 070079
 Ürün Adı : LAY4-EV640 LED'Lİ SİNYAL L.
 Ambalaj Ad. : 20
 Fiyat : 3.456 USD.



Ürün Kodu : 084 132 000003
 Ürün Adı : AP-9 DÖK.KOR.KPK. PEDAL
 1NO+1NC GRİ-SARI
 Ambalaj Ad. : 1
 Fiyat : 30.000 USD.



Ürün Kodu : 888 090 070064
 Ürün Adı : LAY4-EW3371 LED'Lİ YAYLI
 STR. BUT. IP40
 Ambalaj Ad. : 20
 Fiyat : 5.130 USD.

Renk : B Y K R



Ürün Kodu : 084 132 000004
 Ürün Adı : AP-9C DÖK.KOR.KPK.PEDAL
 2NO+2NC GRİ-SARI
 Ambalaj Ad. : 11
 Fiyat : 42.500 USD.



Ürün Kodu : 888 090 070065
 Ürün Adı : LAY4-EW3472 LED'Lİ YAYLI
 STP. BUT. IP40
 Ambalaj Ad. : 20
 Fiyat : 5.130 USD.

Renk : R



Ürün Kodu : 888 090 070069
 Ürün Adı : LAY4-EW8465 LED'Lİ YAYLI
 İKİZ BUT. IP40
 Ambalaj Ad. : 20
 Fiyat : 5.994 USD.

Renk : R G

Ürün Kodu	Açıklama / Stok Cinsi	Ambalaj (Kutulu)	Ambalaj Birimi	Fiyat
DÖNER LAMBA, FLAŞÖR, SİREN, REFKONTAK				
102 111 000012	LEDLİ FLAŞÖRLÜ ELEKTRONİK SİREN 12V	1	ad.	25.000
102 111 000024	LEDLİ FLAŞÖRLÜ ELEKTRONİK SİREN 24V	1	ad.	25.000
102 111 000220	LEDLİ FLAŞÖRLÜ ELEKTRONİK SİREN 220V	1	ad.	28.750
102 111 010012	SENSÖRLÜ ELEKTRONİK SİREN 12V	1	ad.	50.000
102 111 010024	SENSÖRLÜ ELEKTRONİK SİREN 24V	1	ad.	50.000
102 111 010220	SENSÖRLÜ ELEKTRONİK SİREN 220V	1	ad.	55.000
888 111 050004	MS190 MİNİ SİREN	1	ad.	12.00 USD.
888 111 050005	MS290P PLASTİK SİREN 220V	1	ad.	31.000
026 111 000001	UÇAK İKAZ LAMBASI (AMPULLÜ)	1	ad.	100.000
026 111 000002	UÇAK İKAZ LAMBA SEHPASI	1	ad.	75.000
026 111 010001	AS. 1 MOTORLU SİREN (PLS.GÖV.)220V,150W	1	ad.	55.000
026 111 010002	AS. 2 MOTORLU SİREN (PLS.GÖV.)220V,200W	1	ad.	78.750
026 111 010003	AS. 1 MOTORLU SİREN (METAL.GÖV.)220V,150W	1	ad.	90.000
026 111 010004	AS. 2 MOTORLU SİREN (METAL.GÖV.)220V,200W	1	ad.	120.000
026 111 010005	AS.3 MOTORLU SİREN 220V-280W	1	ad.	562.500
001 111 020004 00 00	DÖNER LAMBA 220 V AC	1	ad.	37.950
001 111 020001 00 00	DÖNER LAMBA 12 V AC	1	ad.	37.950
001 111 020002 00 00	DÖNER LAMBA 24 V AC	1	ad.	44.000
001 111 030003 00 00	FLAŞÖRLÜ İKAZ LAMBASI 220 V	1	ad.	26.450
026 111 020005	12 V.DC.MIKNATISLI DÖNER LAMBA(OTO TİPİ)	1	ad.	75.000



IL-XM45 SERİSİ Ø 45 MODÜLER SİSTEM İKAZ LAMBA LENSLERİ

129 087 000001	IL-XM45S-12	OPSİYONEL TAB. MONTAJ	1	ad.	29.000 USD.
129 087 000002	IL-XM45S-24	OPSİYONEL TAB. MONTAJ	1	ad.	29.000 USD.
129 087 000003	IL-XM45S-48	OPSİYONEL TAB. MONTAJ	1	ad.	65.000 USD.
129 087 000004	IL-XM45S-110	OPSİYONEL TAB. MONTAJ	1	ad.	65.000 USD.
129 087 000005	IL-XM45S-220	OPSİYONEL TAB. MONTAJ	1	ad.	29.000 USD.

IL-XT45G SERİSİ Ø 45 MODÜLER SİSTEM İKAZ LAMBA GÖVDELERİ

129 087 000006	IL-XT45G-24S	SABİT 24V	1	ad.	23.000 USD.
129 087 000007	IL-XT45G-24SB	SABİT BUZZER İLE BİRLİKTE 24V	1	ad.	29.000 USD.
129 087 000008	IL-XT45G-24F	FLAŞÖR 24V	1	ad.	35.000 USD.
129 087 000009	IL-XT45G-24FB	FLAŞÖR BUZZER İLE BİRLİKTE 24V	1	ad.	40.000 USD.
129 087 000010	IL-XT45G-220S	SABİT 220V	1	ad.	29.000 USD.
129 087 000011	IL-XT45G-220SB	SABİT BUZZER İLE BİRLİKTE 220V	1	ad.	35.000 USD.
129 087 000012	IL-XT45G-220F	FLAŞÖR 220V	1	ad.	40.000 USD.
129 087 000013	IL-XT45G-220FB	FLAŞÖR BUZZER İLE BİRLİKTE 220V	1	ad.	46.000 USD.

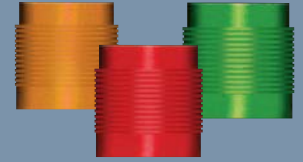

IL-XT45G LENSLER



IL-XT45G GÖVDE





IL-XM67X LENS



IL-XT67G GÖVDE



IL-X..VT6 SERİSİ

Ürün Kodu	Çalışma Şekli	Montaj Şekli	Besleme Gerilimi	Ambalaj (Poşet)	Ambalaj Birimi	Fiyat
IL-XM67 SERİSİ Ø 67 MODÜLER SİSTEM İKAZ LAMBA LENSLERİ						
129 087 000014	IL-XM67S-12	SABİT IŞIKLI	TABANA MONTAJ	12VAC/DC	1 ad.	25.000 USD.
129 087 000015	IL-XM67S-24	SABİT IŞIKLI	TABANA MONTAJ	24VAC/DC	1 ad.	25.000 USD.
129 087 000016	IL-XM67S-48	SABİT IŞIKLI	TABANA MONTAJ	48VAC/DC	1 ad.	55.000 USD.
129 087 000017	IL-XM67S-110	SABİT IŞIKLI	TABANA MONTAJ	110VAC	1 ad.	55.000 USD.
129 087 000018	IL-XM67S-220	SABİT IŞIKLI	TABANA MONTAJ	220VAC	1 ad.	25.000 USD.
129 087 000019	IL-XM67F-12	FLAŞÖRLÜ	TABANA MONTAJ	12VAC/DC	1 ad.	44.000 USD.
129 087 000020	IL-XM67F-24	FLAŞÖRLÜ	TABANA MONTAJ	24VAC/DC	1 ad.	44.000 USD.
129 087 000021	IL-XM67F-48	FLAŞÖRLÜ	TABANA MONTAJ	48VAC/DC	1 ad.	90.000 USD.
129 087 000022	IL-XM67F-110	FLAŞÖRLÜ	TABANA MONTAJ	110VAC	1 ad.	90.000 USD.
129 087 000023	IL-XM67F-220	FLAŞÖRLÜ	TABANA MONTAJ	220VAC	1 ad.	44.000 USD.
129 087 000024	IL-XM67Ç-12	ÇAKAR	TABANA MONTAJ	12VAC/DC	1 ad.	52.000 USD.
129 087 000025	IL-XM67Ç-24	ÇAKAR	TABANA MONTAJ	24VAC/DC	1 ad.	52.000 USD.
129 087 000026	IL-XM67Ç-48	ÇAKAR	TABANA MONTAJ	48VAC/DC	1 ad.	110.000 USD.
129 087 000027	IL-XM67Ç-110	ÇAKAR	TABANA MONTAJ	110VAC	1 ad.	110.000 USD.
129 087 000028	IL-XM67Ç-220	ÇAKAR	TABANA MONTAJ	220VAC	1 ad.	52.000 USD.
129 087 000029	IL-XM67D-12	DÖNER	TABANA MONTAJ	12VAC/DC	1 ad.	52.000 USD.
129 087 000030	IL-XM67D-24	DÖNER	TABANA MONTAJ	24VAC/DC	1 ad.	52.000 USD.
129 087 000031	IL-XM67D-48	DÖNER	TABANA MONTAJ	48VAC/DC	1 ad.	110.000 USD.
129 087 000032	IL-XM67D-110	DÖNER	TABANA MONTAJ	110VAC	1 ad.	110.000 USD.
129 087 000033	IL-XM67D-220	DÖNER	TABANA MONTAJ	220VAC	1 ad.	52.000 USD.
129 087 000034	IL-XM67B-12	BUZZER	TABANA MONTAJ	12VAC/DC	1 ad.	29.000 USD.
129 087 000035	IL-XM67B-24	BUZZER	TABANA MONTAJ	24VAC/DC	1 ad.	29.000 USD.
129 087 000036	IL-XM67B-48	BUZZER	TABANA MONTAJ	48VAC/DC	1 ad.	65.000 USD.
129 087 000037	IL-XM67B-110	BUZZER	TABANA MONTAJ	110VAC	1 ad.	65.000 USD.
129 087 000038	IL-XM67B-220	BUZZER	TABANA MONTAJ	220VAC	1 ad.	29.000 USD.
129 087 000039	IL-XT67-G	GÖVDE			1 ad.	18.000 USD.
RENK SEÇENEKLERİ: IL-XM67S-12K ● IL-XM67S-12S ● IL-XM67S-12Y ● IL-XM67S-12M ● IL-XM67S-12B ○						
IL-X..VT6 SERİSİ Ø 60 İKAZ LAMBALARI						
129 087 000369	IL-XLS-VT6-12K	SABİT IŞIKLI	TABANA MONTAJ	12VDC	1 ad.	33.000 USD.
129 087 000040	IL-XLS-VT6-24K	SABİT IŞIKLI	TABANA MONTAJ	24VDC	1 ad.	33.000 USD.
129 087 000041	IL-XLS-VT6-220K	SABİT IŞIKLI	TABANA MONTAJ	220VAC	1 ad.	38.000 USD.
129 087 000042	IL-XLF-VT6-12K	FLAŞÖRLÜ	TABANA MONTAJ	12VDC	1 ad.	43.000 USD.
129 087 000043	IL-XLF-VT6-24K	FLAŞÖRLÜ	TABANA MONTAJ	24VDC	1 ad.	43.000 USD.
129 087 000044	IL-XLF-VT6-220K	FLAŞÖRLÜ	TABANA MONTAJ	220VAC	1 ad.	49.000 USD.
129 087 000045	IL-XÇ-VT6-12K	ÇAKAR	TABANA MONTAJ	12VDC	1 ad.	58.000 USD.
129 087 000046	IL-XÇ-VT6-24K	ÇAKAR	TABANA MONTAJ	24VDC	1 ad.	58.000 USD.
129 087 000047	IL-XÇ-VT6-220K	ÇAKAR	TABANA MONTAJ	220VAC	1 ad.	58.000 USD.
129 087 000048	IL-XÇ2-VT6-220K	ÇİFT ÇAKAR	TABANA MONTAJ	220VAC	1 ad.	58.000 USD.
129 087 000049	IL-XLD-VT6-12K	LEDLİ DÖNER	TABANA MONTAJ	12VDC	1 ad.	53.000 USD.
129 087 000050	IL-XLD-VT6-24K	LEDLİ DÖNER	TABANA MONTAJ	24VDC	1 ad.	53.000 USD.
129 087 000051	IL-XLD-VT6-220K	LEDLİ DÖNER	TABANA MONTAJ	220VAC	1 ad.	60.000 USD.
129 087 000052	IL-XLSB-VT6-12K	SABİT IŞIKLI+BUZZER	TABANA MONTAJ	12VDC	1 ad.	45.000 USD.
129 087 000053	IL-XLSB-VT6-24K	SABİT IŞIKLI+BUZZER	TABANA MONTAJ	24VDC	1 ad.	45.000 USD.
129 087 000054	IL-XLSB-VT6-220K	SABİT IŞIKLI+BUZZER	TABANA MONTAJ	220VAC	1 ad.	50.000 USD.
129 087 000055	IL-XLFB-VT6-12K	FLAŞÖRLÜ+BUZZER	TABANA MONTAJ	12VDC	1 ad.	50.000 USD.
129 087 000056	IL-XLFB-VT6-24K	FLAŞÖRLÜ+BUZZER	TABANA MONTAJ	24VDC	1 ad.	50.000 USD.
129 087 000057	IL-XLFB-VT6-220K	FLAŞÖRLÜ+BUZZER	TABANA MONTAJ	220VAC	1 ad.	55.000 USD.
129 087 000058	IL-XÇB-VT6-12K	ÇAKAR+BUZZER	TABANA MONTAJ	12VDC	1 ad.	75.000 USD.
129 087 000059	IL-XÇB-VT6-24K	ÇAKAR+BUZZER	TABANA MONTAJ	24VDC	1 ad.	75.000 USD.
129 087 000060	IL-XÇB-VT6-220K	ÇAKAR+BUZZER	TABANA MONTAJ	220VAC	1 ad.	75.000 USD.
129 087 000061	IL-XLDB-VT6-12K	LEDLİ DÖNER+BUZZER	TABANA MONTAJ	12VDC	1 ad.	64.000 USD.
129 087 000062	IL-XLDB-VT6-24K	LEDLİ DÖNER+BUZZER	TABANA MONTAJ	24VDC	1 ad.	64.000 USD.
129 087 000063	IL-XLDB-VT6-220K	LEDLİ DÖNER+BUZZER	TABANA MONTAJ	220VAC	1 ad.	70.000 USD.
RENK SEÇENEKLERİ: IL-XLS-VT6-12K ● IL-XLS-VT6-12S ● IL-XLS-VT6-12Y ● IL-XLS-VT6-12M ● IL-XLS-VT6-12B ○						

Ürün Kodu	Çalışma Şekli	Montaj Şekli	Besleme Gerilimi	Ambalaj (Poşet)	Ambalaj Birimi	Fiyat
İL-XV8 SERİSİ Q 84 İKAZ LAMBALARI						
129 087 000064	İL-XLS-V8-12K	SABİT IŞIKLI	VİDA BAĞLANTI	12VDC	1 ad.	19.000 USD.
129 087 000065	İL-XLS-V8-24K	SABİT IŞIKLI	VİDA BAĞLANTI	24VDC	1 ad.	19.000 USD.
129 087 000066	İL-XLS-V8-220K	SABİT IŞIKLI	VİDA BAĞLANTI	220VAC	1 ad.	23.000 USD.
129 087 000067	İL-XLF-V8-12K	FLAŞÖRLÜ	VİDA BAĞLANTI	12VDC	1 ad.	27.000 USD.
129 087 000068	İL-XLF-V8-24K	FLAŞÖRLÜ	VİDA BAĞLANTI	24VDC	1 ad.	27.000 USD.
129 087 000069	İL-XLF-V8-220K	FLAŞÖRLÜ	VİDA BAĞLANTI	220VAC	1 ad.	32.000 USD.
129 087 000070	İL-XÇ-V8-12K	ÇAKAR	VİDA BAĞLANTI	12VDC	1 ad.	40.000 USD.
129 087 000071	İL-XÇ-V8-24K	ÇAKAR	VİDA BAĞLANTI	24VDC	1 ad.	40.000 USD.
129 087 000072	İL-XÇ-V8-220K	ÇAKAR	VİDA BAĞLANTI	220VAC	1 ad.	45.000 USD.
129 087 000073	İL-XÇ2-V8-220K	ÇİFT ÇAKAR	VİDA BAĞLANTI	220VAC	1 ad.	55.000 USD.
129 087 000074	İL-XLD-V8-12K	LEDLİ DÖNER	VİDA BAĞLANTI	12VDC	1 ad.	50.000 USD.
129 087 000075	İL-XLD-V8-24K	LEDLİ DÖNER	VİDA BAĞLANTI	24VDC	1 ad.	50.000 USD.
129 087 000076	İL-XLD-V8-220K	LEDLİ DÖNER	VİDA BAĞLANTI	220VAC	1 ad.	55.000 USD.
129 087 000077	İL-XLSB-V8-12K	SABİT IŞIKLI+BUZZER	VİDA BAĞLANTI	12VDC	1 ad.	25.000 USD.
129 087 000078	İL-XLSB-V8-24K	SABİT IŞIKLI+BUZZER	VİDA BAĞLANTI	24VDC	1 ad.	25.000 USD.
129 087 000079	İL-XLSB-V8-220K	SABİT IŞIKLI+BUZZER	VİDA BAĞLANTI	220VAC	1 ad.	30.000 USD.
129 087 000080	İL-XLFB-V8-12K	FLAŞÖRLÜ+BUZZER	VİDA BAĞLANTI	12VDC	1 ad.	30.000 USD.
129 087 000081	İL-XLFB-V8-24K	FLAŞÖRLÜ+BUZZER	VİDA BAĞLANTI	24VDC	1 ad.	30.000 USD.
129 087 000082	İL-XLFB-V8-220K	FLAŞÖRLÜ+BUZZER	VİDA BAĞLANTI	220VAC	1 ad.	35.000 USD.
129 087 000083	İL-XÇB-V8-12K	ÇAKAR+BUZZER	VİDA BAĞLANTI	12VDC	1 ad.	50.000 USD.
129 087 000084	İL-XÇB-V8-24K	ÇAKAR+BUZZER	VİDA BAĞLANTI	24VDC	1 ad.	50.000 USD.
129 087 000085	İL-XÇB-V8-220K	ÇAKAR+BUZZER	VİDA BAĞLANTI	220VAC	1 ad.	55.000 USD.
129 087 000086	İL-XLDB-V8-12K	LEDLİ DÖNER+BUZZER	VİDA BAĞLANTI	12VDC	1 ad.	63.000 USD.
129 087 000087	İL-XLDB-V8-24K	LEDLİ DÖNER+BUZZER	VİDA BAĞLANTI	24VDC	1 ad.	63.000 USD.
129 087 000088	İL-XLDB-V8-220K	LEDLİ DÖNER+BUZZER	VİDA BAĞLANTI	220VAC	1 ad.	68.000 USD.
RENK SEÇENEKLERİ: İL-XLS-V8-12K ● İL-XLS-V8-12S ● İL-XLS-V8-12Y ● İL-XLS-V8-12M ● İL-XLS-V8-12B ○						



İL-X...V8 SERİSİ

SABİT IŞIKLI İL-X-T8 SERİSİ İKAZ LAMBALARI						
129 087 000089	İL-XLS-T8-12K	SABİT IŞIKLI	TABANA MONTAJ	12VDC	1 ad.	19.000 USD.
129 087 000090	İL-XLS-T8-24K	SABİT IŞIKLI	TABANA MONTAJ	24VDC	1 ad.	19.000 USD.
129 087 000091	İL-XLS-T8-220K	SABİT IŞIKLI	TABANA MONTAJ	220VAC	1 ad.	23.000 USD.
129 087 000092	İL-XLF-T8-12K	FLAŞÖRLÜ	TABANA MONTAJ	12VDC	1 ad.	27.000 USD.
129 087 000093	İL-XLF-T8-24K	FLAŞÖRLÜ	TABANA MONTAJ	24VDC	1 ad.	27.000 USD.
129 087 000094	İL-XLF-T8-220K	FLAŞÖRLÜ	TABANA MONTAJ	220VAC	1 ad.	32.000 USD.
129 087 000095	İL-XÇ-T8-12K	ÇAKAR	TABANA MONTAJ	12VDC	1 ad.	40.000 USD.
129 087 000096	İL-XÇ-T8-24K	ÇAKAR	TABANA MONTAJ	24VDC	1 ad.	40.000 USD.
129 087 000097	İL-XÇ-T8-220K	ÇAKAR	TABANA MONTAJ	220VAC	1 ad.	45.000 USD.
129 087 000098	İL-XÇ2-T8-220K	ÇİFT ÇAKAR	TABANA MONTAJ	220VAC	1 ad.	55.000 USD.
129 087 000099	İL-XLD-T8-12K	LEDLİ DÖNER	TABANA MONTAJ	12VDC	1 ad.	50.000 USD.
129 087 000100	İL-XLD-T8-24K	LEDLİ DÖNER	TABANA MONTAJ	24VDC	1 ad.	50.000 USD.
129 087 000101	İL-XLD-T8-220K	LEDLİ DÖNER	TABANA MONTAJ	220VAC	1 ad.	55.000 USD.
129 087 000102	İL-XLSB-T8-12K	SABİT IŞIKLI+BUZZER	TABANA MONTAJ	12VDC	1 ad.	25.000 USD.
129 087 000103	İL-XLSB-T8-24K	SABİT IŞIKLI+BUZZER	TABANA MONTAJ	24VDC	1 ad.	25.000 USD.
129 087 000104	İL-XLSB-T8-220K	SABİT IŞIKLI+BUZZER	TABANA MONTAJ	220VAC	1 ad.	30.000 USD.
129 087 000105	İL-XLFB-T8-12K	FLAŞÖRLÜ+BUZZER	TABANA MONTAJ	12VDC	1 ad.	30.000 USD.
129 087 000106	İL-XLFB-T8-24K	FLAŞÖRLÜ+BUZZER	TABANA MONTAJ	24VDC	1 ad.	30.000 USD.
129 087 000107	İL-XLFB-T8-220K	FLAŞÖRLÜ+BUZZER	TABANA MONTAJ	220VAC	1 ad.	35.000 USD.
129 087 000108	İL-XÇB-T8-12K	ÇAKAR+BUZZER	TABANA MONTAJ	12VDC	1 ad.	50.000 USD.
129 087 000109	İL-XÇB-T8-24K	ÇAKAR+BUZZER	TABANA MONTAJ	24VDC	1 ad.	50.000 USD.
129 087 000110	İL-XÇB-T8-220K	ÇAKAR+BUZZER	TABANA MONTAJ	220VAC	1 ad.	55.000 USD.
129 087 000111	İL-XLDB-T8-12K	LEDLİ DÖNER+BUZZER	TABANA MONTAJ	12VDC	1 ad.	63.000 USD.
129 087 000112	İL-XLDB-T8-24K	LEDLİ DÖNER+BUZZER	TABANA MONTAJ	24VDC	1 ad.	63.000 USD.
129 087 000113	İL-XLDB-T8-220K	LEDLİ DÖNER+BUZZER	TABANA MONTAJ	220VDC	1 ad.	68.000 USD.
RENK SEÇENEKLERİ: İL-XLS-T8-12K ● İL-XLS-T8-12S ● İL-XLS-T8-12Y ● İL-XLS-T8-12M ● İL-XLS-T8-12B ○						



İL-X...T8 SERİSİ



IL-X...-VT8 SERİSİ



IL-X...-VT10 SERİSİ

Ürün Kodu	Çalışma Şekli	Montaj Şekli	Besleme Gerilimi	Ambalaj (Poşet)	Ambalaj Birimi	Fiyat
IL-X-VT..8 SERİSİ Ø 84 İKAZ LAMBALARI						
129 087 000114	IL-XLS-VT8-12K	SABİT İŞIKLI	TABANA MONTAJ	12VDC	1 ad.	19.000 USD.
129 087 000115	IL-XLS-VT8-24K	SABİT İŞIKLI	TABANA MONTAJ	24VDC	1 ad.	19.000 USD.
129 087 000116	IL-XLS-VT8-220K	SABİT İŞIKLI	TABANA MONTAJ	220VAC	1 ad.	23.000 USD.
129 087 000117	IL-XLF-VT8-12K	FLAŞÖRLÜ	TABANA MONTAJ	12VDC	1 ad.	27.000 USD.
129 087 000118	IL-XLF-VT8-24K	FLAŞÖRLÜ	TABANA MONTAJ	24VDC	1 ad.	27.000 USD.
129 087 000119	IL-XLF-VT8-220K	FLAŞÖRLÜ	TABANA MONTAJ	220VAC	1 ad.	32.000 USD.
129 087 000120	IL-XÇ-VT8-12K	ÇAKAR	TABANA MONTAJ	12VDC	1 ad.	40.000 USD.
129 087 000121	IL-XÇ-VT8-24K	ÇAKAR	TABANA MONTAJ	24VDC	1 ad.	40.000 USD.
129 087 000122	IL-XÇ-VT8-220K	ÇAKAR	TABANA MONTAJ	220VAC	1 ad.	45.000 USD.
129 087 000123	IL-XÇ2-VT8-220K	ÇİFT ÇAKAR	TABANA MONTAJ	220VAC	1 ad.	55.000 USD.
129 087 000124	IL-XLD-VT8-12K	LEDLİ DÖNER	TABANA MONTAJ	12VDC	1 ad.	50.000 USD.
129 087 000125	IL-XLD-VT8-24K	LEDLİ DÖNER	TABANA MONTAJ	24VDC	1 ad.	50.000 USD.
129 087 000126	IL-XLD-VT8-220K	LEDLİ DÖNER	TABANA MONTAJ	220VAC	1 ad.	55.000 USD.
129 087 000127	IL-XLSB-VT8-12K	SABİT İŞIKLI+BUZZER	TABANA MONTAJ	12VDC	1 ad.	25.000 USD.
129 087 000128	IL-XLSB-VT8-24K	SABİT İŞIKLI+BUZZER	TABANA MONTAJ	24VDC	1 ad.	25.000 USD.
129 087 000129	IL-XLSB-VT8-220K	SABİT İŞIKLI+BUZZER	TABANA MONTAJ	220VAC	1 ad.	30.000 USD.
129 087 000130	IL-XLFB-VT8-12K	FLAŞÖRLÜ+BUZZER	TABANA MONTAJ	12VDC	1 ad.	30.000 USD.
129 087 000131	IL-XLFB-VT8-24K	FLAŞÖRLÜ+BUZZER	TABANA MONTAJ	24VDC	1 ad.	30.000 USD.
129 087 000132	IL-XLFB-VT8-220K	FLAŞÖRLÜ+BUZZER	TABANA MONTAJ	220VAC	1 ad.	35.000 USD.
129 087 000133	IL-XÇB-VT8-12K	ÇAKAR+BUZZER	TABANA MONTAJ	12VDC	1 ad.	50.000 USD.
129 087 000134	IL-XÇB-VT8-24K	ÇAKAR+BUZZER	TABANA MONTAJ	24VDC	1 ad.	50.000 USD.
129 087 000135	IL-XÇB-VT8-220K	ÇAKAR+BUZZER	TABANA MONTAJ	220VAC	1 ad.	55.000 USD.
129 087 000136	IL-XLDB-VT8-12K	LEDLİ DÖNER+BUZZER	TABANA MONTAJ	12VDC	1 ad.	63.000 USD.
129 087 000137	IL-XLDB-VT8-24K	LEDLİ DÖNER+BUZZER	TABANA MONTAJ	24VDC	1 ad.	63.000 USD.
129 087 000138	IL-XLDB-VT8-220K	LEDLİ DÖNER+BUZZER	TABANA MONTAJ	220VAC	1 ad.	68.000 USD.
RENK SEÇENEKLERİ: IL-XLS-VT8-12K ● IL-XLS-VT8-12S ● IL-XLS-VT8-12Y ● IL-XLS-VT8-12M ● IL-XLS-VT8-12B ○						
IL-X...-VT10 SERİSİ Ø 100 İKAZ LAMBALARI						
129 087 000139	IL-XLS-VT10-12K	SABİT İŞIKLI	TABANA MONTAJ	12VDC	1 ad.	40.000 USD.
129 087 000140	IL-XLS-VT10-24K	SABİT İŞIKLI	TABANA MONTAJ	24VDC	1 ad.	40.000 USD.
129 087 000141	IL-XLS-VT10-220K	SABİT İŞIKLI	TABANA MONTAJ	220VAC	1 ad.	48.000 USD.
129 087 000142	IL-XLF-VT10-12K	FLAŞÖRLÜ	TABANA MONTAJ	12VDC	1 ad.	52.000 USD.
129 087 000143	IL-XLF-VT10-24K	FLAŞÖRLÜ	TABANA MONTAJ	24VDC	1 ad.	52.000 USD.
129 087 000144	IL-XLF-VT10-220K	FLAŞÖRLÜ	TABANA MONTAJ	220VAC	1 ad.	60.000 USD.
129 087 000145	IL-XÇ-VT10-12K	ÇAKAR	TABANA MONTAJ	12VDC	1 ad.	69.000 USD.
129 087 000146	IL-XÇ-VT10-24K	ÇAKAR	TABANA MONTAJ	24VDC	1 ad.	69.000 USD.
129 087 000147	IL-XÇ-VT10-220K	ÇAKAR	TABANA MONTAJ	220VAC	1 ad.	79.000 USD.
129 087 000148	IL-XÇ2-VT10-220K	ÇAKAR	TABANA MONTAJ	220VAC	1 ad.	81.000 USD.
129 087 000149	IL-XLD-VT10-12K	LEDLİ DÖNER	TABANA MONTAJ	12VDC	1 ad.	69.000 USD.
129 087 000150	IL-XLD-VT10-24K	LEDLİ DÖNER	TABANA MONTAJ	24VDC	1 ad.	69.000 USD.
129 087 000151	IL-XLD-VT10-220K	LEDLİ DÖNER	TABANA MONTAJ	220VAC	1 ad.	79.000 USD.
129 087 000152	IL-XLSB-VT10-12K	SABİT İŞIKLI + BUZZER	TABANA MONTAJ	12VDC	1 ad.	52.000 USD.
129 087 000153	IL-XLSB-VT10-24K	SABİT İŞIKLI + BUZZER	TABANA MONTAJ	24VDC	1 ad.	52.000 USD.
129 087 000154	IL-XLSB-VT10-220K	SABİT İŞIKLI + BUZZER	TABANA MONTAJ	220VAC	1 ad.	60.000 USD.
129 087 000155	IL-XLFB-VT10-12K	FLAŞÖRLÜ + BUZZER	TABANA MONTAJ	12VDC	1 ad.	63.000 USD.
129 087 000156	IL-XLFB-VT10-24K	FLAŞÖRLÜ + BUZZER	TABANA MONTAJ	24VDC	1 ad.	63.000 USD.
129 087 000157	IL-XLFB-VT10-220K	FLAŞÖRLÜ + BUZZER	TABANA MONTAJ	220VAC	1 ad.	73.000 USD.
129 087 000158	IL-XÇB-VT10-12K	ÇAKAR + BUZZER	TABANA MONTAJ	12VDC	1 ad.	110.000 USD.
129 087 000159	IL-XÇB-VT10-24K	ÇAKAR + BUZZER	TABANA MONTAJ	24VDC	1 ad.	110.000 USD.
129 087 000160	IL-XÇB-VT10-220K	ÇAKAR + BUZZER VİDA	TABANA MONTAJ	220VAC	1 ad.	120.000 USD.
129 087 000161	IL-XLDB-VT10-12K	LEDLİ DÖNER + BUZZER	TABANA MONTAJ	12VDC	1 ad.	86.000 USD.
129 087 000162	IL-XLDB-VT10-24K	LEDLİ DÖNER + BUZZER	TABANA MONTAJ	24VDC	1 ad.	86.000 USD.
129 087 000163	IL-XLDB-VT10-220K	LEDLİ DÖNER + BUZZER	TABANA MONTAJ	220VAC	1 ad.	96.000 USD.
RENK SEÇENEKLERİ: IL-XLS-VT10-12K ● IL-XLS-VT10-12S ● IL-XLS-VT10-12Y ● IL-XLS-VT8-12M ● IL-XLS-VT10-12B ○						

Ürün Kodu	Çalışma Şekli	Montaj Şekli	Besleme Gerilimi	Ambalaj (Poşet)	Ambalaj Birimi	Fiyat
IL-X...-VT12 SERİSİ Ø 120 İKAZ LAMBALARI						
129 087 000164	IL-XLS-VT12-12K	SABİT IŞIKLI	TABANA MONTAJ	12VDC	1 ad.	46.000 USD.
129 087 000165	IL-XLS-VT12-24K	SABİT IŞIKLI	TABANA MONTAJ	24VDC	1 ad.	46.000 USD.
129 087 000166	IL-XLS-VT12-220K	SABİT IŞIKLI	TABANA MONTAJ	220VAC	1 ad.	56.000 USD.
129 087 000167	IL-XLF-VT12-12K	FLAŞÖRLÜ	TABANA MONTAJ	12VDC	1 ad.	58.000 USD.
129 087 000168	IL-XLF-VT12-24K	FLAŞÖRLÜ	TABANA MONTAJ	24VDC	1 ad.	58.000 USD.
129 087 000169	IL-XLF-VT12-220K	FLAŞÖRLÜ	TABANA MONTAJ	220VAC	1 ad.	68.000 USD.
129 087 000170	IL-XÇ-VT12-12K	ÇAKAR	TABANA MONTAJ	12VDC	1 ad.	75.000 USD.
129 087 000171	IL-XÇ-VT12-24K	ÇAKAR	TABANA MONTAJ	24VDC	1 ad.	75.000 USD.
129 087 000172	IL-XÇ-VT12-220K	ÇAKAR	TABANA MONTAJ	220VAC	1 ad.	85.000 USD.
129 087 000173	IL-XÇ2-VT12-220K	ÇİFT ÇAKAR	TABANA MONTAJ	220VAC	1 ad.	98.000 USD.
129 087 000174	IL-XLSB-VT12-12K	LEDLİ DÖNER	TABANA MONTAJ	12VDC	1 ad.	75.000 USD.
129 087 000175	IL-XLSB-VT12-24K	LEDLİ DÖNER	TABANA MONTAJ	24VDC	1 ad.	75.000 USD.
129 087 000176	IL-XLSB-VT12-220K	LEDLİ DÖNER	TABANA MONTAJ	220VAC	1 ad.	85.000 USD.
129 087 000177	IL-XLFB-VT12-12K	SABİT IŞIKLI + BUZZER	TABANA MONTAJ.	12VDC	1 ad.	58.000 USD.
129 087 000178	IL-XLFB-VT12-24K	SABİT IŞIKLI + BUZZER	TABANA MONTAJ.	24VDC	1 ad.	58.000 USD.
129 087 000179	IL-XLFB-VT12-220K	SABİT IŞIKLI + BUZZER	TABANA MONTAJ.	220VAC	1 ad.	68.000 USD.
129 087 000180	IL-XÇB-VT12-12K	FLAŞÖRLÜ + BUZZER	TABANA MONTAJ.	12VDC	1 ad.	69.000 USD.
129 087 000181	IL-XÇB-VT12-24K	FLAŞÖRLÜ + BUZZER	TABANA MONTAJ.	24VDC	1 ad.	69.000 USD.
129 087 000182	IL-XÇB-VT12-220K	FLAŞÖRLÜ + BUZZER	TABANA MONTAJ.	220VAC	1 ad.	79.000 USD.
129 087 000183	IL-XLDB-VT12-12K	ÇAKAR + BUZZER	TABANA MONTAJ.	12VDC	1 ad.	121.000 USD.
129 087 000184	IL-XLDB-VT12-24K	ÇAKAR + BUZZER	TABANA MONTAJ.	24VDC	1 ad.	121.000 USD.
129 087 000185	IL-XLDB-VT12-220K	ÇAKAR + BUZZER	TABANA MONTAJ.	220VAC	1 ad.	132.000 USD.
129 087 000186	IL-XLDB-VT12-12K	LEDLİ DÖNER + BUZZER	TABANA MONTAJ.	12VDC	1 ad.	98.000 USD.
129 087 000187	IL-XLDB-VT12-24K	LEDLİ DÖNER + BUZZER	TABANA MONTAJ.	24VDC	1 ad.	98.000 USD.
129 087 000188	IL-XLDB-VT12-220K	LEDLİ DÖNER + BUZZER	TABANA MONTAJ.	220VAC	1 ad.	110.000 USD.
RENK SEÇENEKLERİ: IL-XLS-VT12-12K ● IL-XLS-VT12-12S ● IL-XLS-VT12-12Y ● IL-XLS-VT12-12M ● IL-XLS-VT12-12B ○						

IL-X...-B SERİSİ Ø67 BORULU İKAZ LAMBALARI

129 087 000189	IL-XLSB-B-12X	SABİT IŞIKLI + BUZZER		12V	1 ad.	58.000 USD.
129 087 000190	IL-XLSB-B-24X	SABİT IŞIKLI + BUZZER		24V	1 ad.	58.000 USD.
129 087 000191	IL-XLSB-B-48X	SABİT IŞIKLI + BUZZER		48V	1 ad.	115.000 USD.
129 087 000192	IL-XLSB-B-110X	SABİT IŞIKLI + BUZZER		110V	1 ad.	115.000 USD.
129 087 000193	IL-XLSB-B-220X	SABİT IŞIKLI + BUZZER		220V	1 ad.	58.000 USD.
129 087 000194	IL-XLFB-B-12X	FLAŞÖRLÜ + BUZZER		12V	1 ad.	69.000 USD.
129 087 000195	IL-XLFB-B-24X	FLAŞÖRLÜ + BUZZER		24V	1 ad.	69.000 USD.
129 087 000196	IL-XLFB-B-48X	FLAŞÖRLÜ + BUZZER		48 V	1 ad.	130.000 USD.
129 087 000197	IL-XLFB-B-110X	FLAŞÖRLÜ + BUZZER		110V	1 ad.	130.000 USD.
129 087 000198	IL-XLFB-B-220X	FLAŞÖRLÜ + BUZZER		220V	1 ad.	69.000 USD.
129 087 000199	IL-XÇB-B-12X	ÇAKAR + BUZZER		12V	1 ad.	63.000 USD.
129 087 000200	IL-XÇB-B-24X	ÇAKAR + BUZZER		24V	1 ad.	63.000 USD.
129 087 000201	IL-XÇB-B-48X	ÇAKAR + BUZZER		48V	1 ad.	125.000 USD.
129 087 000202	IL-XÇB-B-110X	ÇAKAR + BUZZER		110V	1 ad.	125.000 USD.
129 087 000203	IL-XÇB-B-220X	ÇAKAR + BUZZER		220V	1 ad.	63.000 USD.
129 087 000204	IL-XLDB-B-12X	DÖNER + BUZZER		12V	1 ad.	69.000 USD.
129 087 000205	IL-XLDB-B-24X	DÖNER + BUZZER		24V	1 ad.	69.000 USD.
129 087 000206	IL-XLDB-B-48X	DÖNER + BUZZER		48V	1 ad.	130.000 USD.
129 087 000207	IL-XLDB-B-110X	DÖNER + BUZZER		110V	1 ad.	130.000 USD.
129 087 000208	IL-XLDB-B-220X	DÖNER + BUZZER		220V	1 ad.	69.000 USD.
RENK SEÇENEKLERİ: IL-XLSB-B-12K ● IL-XLSB-B-12S ● IL-XLSB-B-12Y ● IL-XLSB-B-12M ● IL-XLSB-B-12B ○						



IL-X...-VT12 SERİSİ



IL-X...-B SERİSİ



IL-X...-Q SERİSİ

Ürün Kodu	Çalışma Şekli	Besleme Gerilimi	Ambalaj (Poşet)	Ambalaj Birimi	Fiyat
-----------	---------------	------------------	-----------------	----------------	-------

IL-X...-Q SERİSİ Ø 67 KÜBİK İKAZ LAMBALARI

129 087 000209	IL-XLSB-Q-12X	SABİT IŞIKLI + BUZZER	12V	1 ad.	58.000 USD.
129 087 000210	IL-XLSB-Q-24X	SABİT IŞIKLI + BUZZER	24V	1 ad.	58.000 USD.
129 087 000211	IL-XLSB-Q-48X	SABİT IŞIKLI + BUZZER	48V	1 ad.	115.000 USD.
129 087 000212	IL-XLSB-Q-110X	SABİT IŞIKLI + BUZZER	110V	1 ad.	115.000 USD.
129 087 000213	IL-XLSB-Q-220X	SABİT IŞIKLI + BUZZER	220V	1 ad.	58.000 USD.
129 087 000214	IL-XLFB-Q-12X	FLAŞÖRLÜ + BUZZER	12V	1 ad.	69.000 USD.
129 087 000215	IL-XLFB-Q-24X	FLAŞÖRLÜ + BUZZER	24V	1 ad.	69.000 USD.
129 087 000216	IL-XLFB-Q-48X	FLAŞÖRLÜ + BUZZER	48V	1 ad.	130.000 USD.
129 087 000217	IL-XLFB-Q-110X	FLAŞÖRLÜ + BUZZER	110V	1 ad.	130.000 USD.
129 087 000218	IL-XLFB-Q-220X	FLAŞÖRLÜ + BUZZER	220V	1 ad.	69.000 USD.

129 087 000219	IL-XÇB-Q-12X	ÇAKAR + BUZZER	12V	1 ad.	63.000 USD.
129 087 000220	IL-XÇB-Q-24X	ÇAKAR + BUZZER	24V	1 ad.	63.000 USD.
129 087 000221	IL-XÇB-Q-48X	ÇAKAR + BUZZER	48V	1 ad.	125.000 USD.
129 087 000222	IL-XÇB-Q-110X	ÇAKAR + BUZZER	110V	1 ad.	125.000 USD.
129 087 000223	IL-XÇB-Q-220X	ÇAKAR + BUZZER	220V	1 ad.	63.000 USD.

129 087 000224	IL-XLDB-Q-12X	DÖNER + BUZZER	12V	1 ad.	69.000 USD.
129 087 000225	IL-XLDB-Q-24X	DÖNER + BUZZER	24V	1 ad.	69.000 USD.
129 087 000226	IL-XLDB-Q-48X	DÖNER + BUZZER	48V	1 ad.	130.000 USD.
129 087 000227	IL-XLDB-Q-110X	DÖNER + BUZZER	110V	1 ad.	130.000 USD.
129 087 000228	IL-XLDB-Q-220X	DÖNER + BUZZER	220V	1 ad.	69.000 USD.

RENK SEÇENEKLERİ: IL-XLSB-Q-12K ● IL-XLSB-Q-12S ● IL-XLSB-Q-12Y ● IL-XLSB-Q-12M ● IL-XLSB-Q-12B ○

Ürün Kodu	Besleme Gerilimi	Ses dB	Çalışma Şekli	Fiyat
-----------	------------------	--------	---------------	-------

IL-XB-B SERİSİ Ø 67 BORULU KORNALAR

129 087 000229	IL-XB-B-12	12V	95dB/30 cm	KESİK KESİK	40.000 USD.
129 087 000230	IL-XB-B-24	24V	95dB/30 cm	KESİK KESİK	40.000 USD.
129 087 000231	IL-XB-B-48	48V	95dB/30 cm	KESİK KESİK	75.000 USD.
129 087 000232	IL-XB-B-110	110V	95dB/30 cm	KESİK KESİK	75.000 USD.
129 087 000233	IL-XB-B-220	220V	95dB/30 cm	KESİK KESİK	40.000 USD.

IL-XB-Q SERİSİ Ø 67 KÜBİK KORNALAR

129 087 000234	IL-XB-Q-12	12V	95dB/30 cm	KESİK KESİK	40.000 USD.
129 087 000235	IL-XB-Q-24	24V	95dB/30 cm	KESİK KESİK	40.000 USD.
129 087 000236	IL-XB-Q-48	48V	95dB/30 cm	KESİK KESİK	75.000 USD.
129 087 000237	IL-XB-Q-110	110V	95dB/30 cm	KESİK KESİK	75.000 USD.
129 087 000238	IL-XB-Q-220	220V	95dB/30 cm	KESİK KESİK	40.000 USD.

IL-XB-B SERİSİ Ø 52 TABANA MONTAJ KORNALAR

129 087 000239	IL-XBD-T5-12	12V	65dB/30 cm	SÜREKLİ SESLİ	40.000 USD.
129 087 000240	IL-XBD-T5-24	24V	65dB/30 cm	SÜREKLİ SESLİ	40.000 USD.
129 087 000241	IL-XBD-T5-220	220V	65dB/30 cm	SÜREKLİ SESLİ	40.000 USD.
129 087 000242	IL-XBK-T5-12	12V	65dB/30 cm	KESİK KESİK	40.000 USD.
129 087 000243	IL-XBK-T5-24 1	24V	65dB/30 cm	KESİK KESİK	40.000 USD.
129 087 000244	IL-XBK-T5-220	220V	65dB/30 cm	KESİK KESİK	40.000 USD.

IL-XFM SERİSİ BUZZER

129 087 000245	IL-XFM-12A-905AL70	12V	90dB/30 cm	ÇİFT SES	KABLOLU	12.000 USD.
129 087 000246	IL-XFM-12Q-905L70	12V	95dB/60 cm	ÇİFT SES	KABLOLU	12.000 USD.
129 087 000247	IL-XFM-24C-905L70	24V	92dB/100 cm	ÇİFT SES	KABLOLU	12.000 USD.
129 087 000248	IL-XFM-220A-905AL70	220V	95dB/30 cm	ÇİFT SES	KABLOLU	12.000 USD.
129 087 000249	IL-XFM-24C-900L700	24V	92dB/100 cm	SÜREKLİ	KABLOLU	12.000 USD.
129 087 000250	IL-XFM-220A-905A	12V	90dB/300 cm	ÇİFT SES	SOKETLİ	12.000 USD.
129 087 000251	IL-XFM-12A-905A	220V	90dB/30 cm	ÇİFT SES	SOKETLİ	12.000 USD.
129 087 000252	IL-XFM-12Q-905	12V	90dB/30 cm	ÇİFT SES	SOKETLİ	12.000 USD.



IL-X-B SERİSİ



IL-X-Q SERİSİ



IL-XFM-24C SERİSİ



IL-X-T SERİSİ



IL-XFM-220A SERİSİ



IL-XFM-12A SERİSİ



IL-XFM-12Q SERİSİ

Ürün Kodu	Çalışma Şekli	Montaj Şekli	Besleme Gerilimi	Ambalaj (Poşet)	Ambalaj Birimi	Fiyat
IL-X...-T5 SERİSİ Ø 52 1 KATLI IŞIKLI KOLONLAR						
129 087 000277	IL-XLS-T5-121	SABİT IŞIKLI	TABANA MONTAJ	12VDC	1 ad.	22.000 USD.
129 087 000278	IL-XLS-T5-241	SABİT IŞIKLI	TABANA MONTAJ	24VDC	1 ad.	22.000 USD.
129 087 000279	IL-XLS-T5-2201	SABİT IŞIKLI	TABANA MONTAJ	220VAC	1 ad.	25.000 USD.
129 087 000280	IL-XLF-T5-121	FLAŞÖRLÜ	TABANA MONTAJ	12VDC	1 ad.	38.000 USD.
129 087 000281	IL-XLF-T5-241	FLAŞÖRLÜ	TABANA MONTAJ	24VDC	1 ad.	38.000 USD.
129 087 000282	IL-XLF-T5-2201	FLAŞÖRLÜ	TABANA MONTAJ	220VAC	1 ad.	41.000 USD.
129 087 000283	IL-XÇ-T5-121	ÇAKAR	TABANA MONTAJ	12VDC	1 ad.	35.000 USD.
129 087 000284	IL-XÇ-T5-241	ÇAKAR	TABANA MONTAJ	24VDC	1 ad.	35.000 USD.
129 087 000285	IL-XÇ-T5-2201	ÇAKAR	TABANA MONTAJ	220VAC	1 ad.	40.000 USD.
129 087 000286	IL-XLSB-T5-121	SABİT IŞIKLI + BUZZER	TABANA MONTAJ	12VDC	1 ad.	40.000 USD.
129 087 000287	IL-XLSB-T5-241	SABİT IŞIKLI + BUZZER	TABANA MONTAJ	24VDC	1 ad.	40.000 USD.
129 087 000288	IL-XLSB-T5-2201	SABİT IŞIKLI + BUZZER	TABANA MONTAJ	220VAC	1 ad.	45.000 USD.
129 087 000289	IL-XLFB-T5-121	FLAŞÖRLÜ + BUZZER	TABANA MONTAJ	12VDC	1 ad.	48.000 USD.
129 087 000290	IL-XLFB-T5-241	FLAŞÖRLÜ + BUZZER	TABANA MONTAJ	24VDC	1 ad.	48.000 USD.
129 087 000291	IL-XLFB-T5-2201	FLAŞÖRLÜ + BUZZER	TABANA MONTAJ	220VAC	1 ad.	53.000 USD.
129 087 000292	IL-XÇB-T5-121	ÇAKAR + BUZZER	TABANA MONTAJ	12VDC	1 ad.	45.000 USD.
129 087 000293	IL-XÇB-T5-241	ÇAKAR + BUZZER	TABANA MONTAJ	24VDC	1 ad.	45.000 USD.
129 087 000294	IL-XÇB-T5-2201	ÇAKAR + BUZZER	TABANA MONTAJ	220 VAC	1 ad.	50.000 USD.
RENK SEÇENEKLERİ: IL-XLS-T5-121 K ● IL-XLS-T5-121 S ● IL-XLS-T5-121 Y ● IL-XLS-T5-121 M ● IL-XLS-T5-121 M ○						
IL-X...-T5 SERİSİ Ø 52 2 KATLI IŞIKLI KOLONLAR						
129 087 000295	IL-XLS-T5-122	SABİT IŞIKLI	TABANA MONTAJ	12VDC	1 ad.	27.000 USD.
129 087 000296	IL-XLS-T5-242	SABİT IŞIKLI	TABANA MONTAJ	24VDC	1 ad.	27.000 USD.
129 087 000297	IL-XLS-T5-2202	SABİT IŞIKLI	TABANA MONTAJ	220VAC	1 ad.	32.000 USD.
129 087 000298	IL-XLF-T5-122	FLAŞÖRLÜ	TABANA MONTAJ	12VDC	1 ad.	42.000 USD.
129 087 000299	IL-XLF-T5-242	FLAŞÖRLÜ	TABANA MONTAJ	24VDC	1 ad.	42.000 USD.
129 087 000300	IL-XLF-T5-2202	FLAŞÖRLÜ	TABANA MONTAJ	220VAC	1 ad.	47.000 USD.
129 087 000301	IL-XLSB-T5-122	SABİT IŞIKLI + BUZZER	TABANA MONTAJ	12VDC	1 ad.	46.000 USD.
129 087 000302	IL-XLSB-T5-242	SABİT IŞIKLI + BUZZER	TABANA MONTAJ	24 VDC	1 ad.	46.000 USD.
129 087 000303	IL-XLSB-T5-2202	SABİT IŞIKLI + BUZZER	TABANA MONTAJ	220 VAC	1 ad.	51.000 USD.
129 087 000304	IL-XLFB-T5-122	FLAŞÖRLÜ + BUZZER	TABANA MONTAJ	12 VDC	1 ad.	52.000 USD.
129 087 000305	IL-XLFB-T5-242	FLAŞÖRLÜ + BUZZER	TABANA MONTAJ	24 VDC	1 ad.	52.000 USD.
129 087 000306	IL-XLFB-T5-2202	FLAŞÖRLÜ + BUZZER	TABANA MONTAJ	220 VAC	1 ad.	57.000 USD.
RENK SEÇENEKLERİ: IL-XLS-T5-122 ● ●						
IL-X...-T5 SERİSİ Ø 52 3 KATLI IŞIKLI KOLONLAR						
129 087 000307	IL-XLS-T5-123	SABİT IŞIKLI	TABANA MONTAJ	12VDC	1 ad.	32.000 USD.
129 087 000308	IL-XLS-T5-243	SABİT IŞIKLI	TABANA MONTAJ	24VDC	1 ad.	32.000 USD.
129 087 000309	IL-XLS-T5-2203	SABİT IŞIKLI	TABANA MONTAJ	220VAC	1 ad.	37.000 USD.
129 087 000310	IL-XLF-T5-123	FLAŞÖRLÜ	TABANA MONTAJ	12VDC	1 ad.	48.000 USD.
129 087 000311	IL-XLF-T5-243	FLAŞÖRLÜ	TABANA MONTAJ	12VDC	1 ad.	48.000 USD.
129 087 000312	IL-XLF-T5-2203	FLAŞÖRLÜ	TABANA MONTAJ	12VDC	1 ad.	53.000 USD.
129 087 000313	IL-XLSB-T5-123	SABİT IŞIKLI + BUZZER	TABANA MONTAJ	12VDC	1 ad.	58.000 USD.
129 087 000314	IL-XLSB-T5-243	SABİT IŞIKLI + BUZZER	TABANA MONTAJ	24VDC	1 ad.	58.000 USD.
129 087 000315	IL-XLSB-T5-2203	SABİT IŞIKLI + BUZZER	TABANA MONTAJ	220VAC	1 ad.	63.000 USD.
129 087 000316	IL-XLFB-T5-123	FLAŞÖRLÜ + BUZZER	TABANA MONTAJ	12VDC	1 ad.	63.000 USD.
129 087 000317	IL-XLFB-T5-243	FLAŞÖRLÜ + BUZZER	TABANA MONTAJ	24VDC	1 ad.	63.000 USD.
129 087 000318	IL-XLFB-T5-2203	FLAŞÖRLÜ + BUZZER	TABANA MONTAJ	220VAC	1 ad.	68.000 USD.
RENK SEÇENEKLERİ: IL-XLS-T5-123 ● ● ●						
IL-X...-T5 SERİSİ Ø 52 4 KATLI IŞIKLI KOLONLAR						
129 087 000253	IL-XLS-T5-124	SABİT IŞIKLI	TABANA MONTAJ	12VDC	1 ad.	40.000 USD.
129 087 000254	IL-XLS-T5-244	SABİT IŞIKLI	TABANA MONTAJ	24VDC	1 ad.	40.000 USD.
129 087 000255	IL-XLS-T5-2204	SABİT IŞIKLI	TABANA MONTAJ	220VAC	1 ad.	48.000 USD.
129 087 000256	IL-XLF-T5-124	FLAŞÖRLÜ	TABANA MONTAJ	12VDC	1 ad.	55.000 USD.
129 087 000257	IL-XLF-T5-244	FLAŞÖRLÜ	TABANA MONTAJ	24VDC	1 ad.	55.000 USD.
129 087 000258	IL-XLF-T5-2204	FLAŞÖRLÜ	TABANA MONTAJ	220VAC	1 ad.	62.000 USD.
129 087 000259	IL-XLSB-T5-124	SABİT IŞIKLI + BUZZER	TABANA MONTAJ	12VDC	1 ad.	65.000 USD.
129 087 000260	IL-XLSB-T5-244	SABİT IŞIKLI + BUZZER	TABANA MONTAJ	24VDC	1 ad.	65.000 USD.
129 087 000261	IL-XLSB-T5-2204	SABİT IŞIKLI + BUZZER	TABANA MONTAJ	220VAC	1 ad.	72.000 USD.
129 087 000262	IL-XLFB-T5-124	FLAŞÖRLÜ + BUZZER	TABANA MONTAJ	12VDC	1 ad.	72.000 USD.
129 087 000263	IL-XLFB-T5-244	FLAŞÖRLÜ + BUZZER	TABANA MONTAJ	24VDC	1 ad.	72.000 USD.
129 087 000264	IL-XLFB-T5-2204	FLAŞÖRLÜ + BUZZER	TABANA MONTAJ	220VAC	1 ad.	80.000 USD.
RENK SEÇENEKLERİ: IL-XLS-T5-124 ● ● ● ●						
IL-X...-T5 SERİSİ Ø 52 5 KATLI IŞIKLI KOLONLAR						
129 087 000265	IL-XLS-T5-125	SABİT IŞIKLI	TABANA MONTAJ	12VDC	1 ad.	46.000 USD.
129 087 000266	IL-XLS-T5-245	SABİT IŞIKLI	TABANA MONTAJ	24VDC	1 ad.	46.000 USD.
129 087 000267	IL-XLS-T5-2205	SABİT IŞIKLI	TABANA MONTAJ	220VAC	1 ad.	54.000 USD.
129 087 000268	IL-XLF-T5-125	FLAŞÖRLÜ	TABANA MONTAJ	12VDC	1 ad.	60.000 USD.
129 087 000269	IL-XLF-T5-245	FLAŞÖRLÜ	TABANA MONTAJ	24VDC	1 ad.	60.000 USD.
129 087 000270	IL-XLF-T5-2205	FLAŞÖRLÜ	TABANA MONTAJ	220VAC	1 ad.	78.000 USD.
129 087 000271	IL-XLSB-T5-125	SABİT IŞIKLI + BUZZER	TABANA MONTAJ	12VDC	1 ad.	70.000 USD.
129 087 000272	IL-XLSB-T5-245	SABİT IŞIKLI + BUZZER	TABANA MONTAJ	24VDC	1 ad.	70.000 USD.
129 087 000273	IL-XLSB-T5-2205	SABİT IŞIKLI + BUZZER	TABANA MONTAJ	220VAC	1 ad.	78.000 USD.
129 087 000274	IL-XLFB-T5-125	FLAŞÖRLÜ + BUZZER	TABANA MONTAJ	12VDC	1 ad.	80.000 USD.
129 087 000275	IL-XLFB-T5-245	FLAŞÖRLÜ + BUZZER	TABANA MONTAJ	24VDC	1 ad.	80.000 USD.
129 087 000276	IL-XLFB-T5-2205	FLAŞÖRLÜ + BUZZER	TABANA MONTAJ	220VAC	1 ad.	90.000 USD.
RENK SEÇENEKLERİ: IL-XLS-T5-125 ● ● ● ● ●						

1 Katlı Işıklı Kolonlar



IL-X...-T5 SERİSİ



IL-X...-T5 BUZZER SERİSİ

2 Katlı Işıklı Kolonlar



IL-X...-T5 SERİSİ



IL-X...-T5 BUZZER SERİSİ

3 Katlı Işıklı Kolonlar

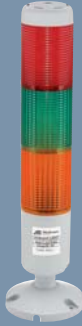

IL-X...-T5 SERİSİ



IL-X...-T5 BUZZER SERİSİ

4 Katlı Işıklı Kolonlar



IL-X...-T5 SERİSİ



5 Katlı Işıklı Kolonlar

ASANSÖR MALZEMELERİ



Ürün Kodu	Açıklama / Stok Cinsi	Ambalaj (Kutulu)	Ambalaj Birimi	Fiyat						
FENAC EKONOMİK SERİ ARITIMLI ENCODER										
	Ürün Adı	Gövde Çapı	Mil Çapı	Besleme Gerilimi	Çıkış Sinyali	Kablo Boyu	Puls			
129 087 000319	ENC 50B-100	50mm	8mm	5-30VDC	ABZ	2m	100	1	ad.	80.000USD.
129 087 000320	ENC 50B-360	50mm	8mm	5-30VDC	ABZ	2m	360	1	ad.	80.000USD.
129 087 000321	ENC 50B-500	50mm	8mm	5-30VDC	ABZ	2m	500	1	ad.	80.000USD.
129 087 000322	ENC 50B-1024	50mm	8mm	5-30VDC	ABZ	7m	1024	1	ad.	100.000USD.
129 087 000323	FNC 58E 8630V 1024-R7	58mm	8mm	5-30VDC	ABZ+Tersleri	7m	1024	1	ad.	155.000USD.
129 087 000324	FNC 58E 12630V 1024-R7	58mm	12mm	5-30VDC	ABZ+Tersleri	7m	1024	1	ad.	155.000USD.
129 087 000325	FNC 80H 25630V 1024-R7	80mm	25mm	5-30VDC	ABZ+Tersleri	7m	1024	1	ad.	210.000USD.
129 087 000326	FNC 100H 32630V 1024-R7	100mm	32mm	5-30VDC	ABZ+Tersleri	7m	1024	1	ad.	240.000USD.
129 087 000327	FNC 100H 38630V 1024-R7	100mm	38mm	5-30VDC	ABZ+Tersleri	7m	1024	1	ad.	240.000USD.

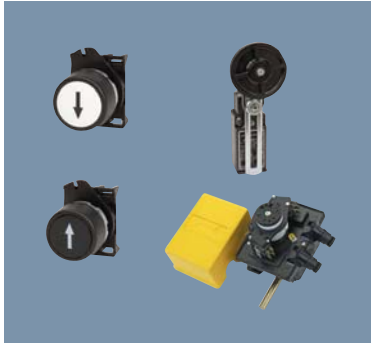

129 087 000328	PPRN5/F Beyaz oklu buton	1	ad.	3.700 EUR.
129 087 000329	PPRN8/F Siyah oklu buton	1	ad.	3.700 EUR.
129 087 000330	PPFN1R3S Acil stop butonu	1	ad.	8.500 EUR.
129 087 000331	PL004001 Bütün butonlar için no kontak	1	ad.	1.750 EUR.
129 087 000332	PL004002 Bütün butonlar için no kontak	1	ad.	1.800 EUR.
129 087 000333	FT140RZ11 Geniş makaralı ayarlanabilir mikro sıvıç	1	ad.	22.000 EUR.
129 087 000334	FGR2006 1/12 Standart versiton 4 mikro sıvıçlı 1/12 tambur limit sıvıç	1	ad.	160.000 EUR.
129 087 000335	FGR2007 1/33 Standart versiton 4 mikro sıvıçlı 1/33 tambur limit sıvıç	1	ad.	160.000 EUR.
129 087 000336	FGR2008 1/50 Standart versiton 4 mikro sıvıçlı 1/33 tambur limit sıvıç	1	ad.	160.000 EUR.
129 087 000337	FGR2009 1/100 Standart versiton 4 mikro sıvıçlı 1/33 tambur limit sıvıç	1	ad.	160.000 EUR.
129 087 000338	FGR2010 1/200 Standart versiton 4 mikro sıvıçlı 1/33 tambur limit sıvıç	1	ad.	160.000 EUR.



129 087 000339	"SMC/P-12L NO 60VA 230V 1NA KONTAK,5MM M16-13MM M20-25MM M30-20MM M300 MIKNATIS İLE"	1	ad.	26.000 EUR.
129 087 000340	"SMC/P-12L NO 220V 1NA KONTAK,8MM M16-20MM M20-40MM M30-50MM M300 MIKNATIS İLE"	1	ad.	23.000 EUR.
129 087 000341	"SMC/P-12L S 150V 1NA KONTAK+1NK KONTAK,6MM M16-17MM M20-33MM M30-23MM M300 MIKNATIS İLE"	1	ad.	30.000 EUR.
129 087 000342	"SMC/P-12LM NO 250V 1NA KONTAK,220V 1NA KONTAK,10MM M20-30MM M30-18 33 MM M300 MIKNATIS İLE"	1	ad.	33.000 EUR.
129 087 000343	"SMC/P-12LM S 500V 1NA KONTAK+220V 1NK KONTAK,10MM M20-33MM M30-18MM M300 MIKNATIS İLE"	1	ad.	47.000 EUR.
129 087 000344	SMC/P-12L BS 200 VAC MIKNATIS SENSÖR 15MM ALGILAMA MESAFESİ 230HZ	1	ad.	25.000 EUR.
129 087 000345	SMC/P-12LM BS 220 VAC MIKNATIS SENSÖR 15MM ALGILAMA MESAFESİ 100HZ	1	ad.	38.000 EUR.



CAMSCO MEKANİK SAYICILARI				
129 087 000346	EC-6R 24V 6 HANELİ MEKANİK SAYICI BESLEME GERİLİMİ 24 VDC	1	ad.	21.000 USD.
129 087 000347	EC-6R 220V 6 HANELİ MEKANİK SAYICI BESLEME GERİLİMİ 220 VAC	1	ad.	21.000 USD.
129 087 000348	"EC-6RS 24V 6 HANELİ RESETLENEBİLİR MEKANİK SAYICI BESLEME GERİLİMİ 24 VDC"	1	ad.	21.000 USD.
129 087 000349	"EC-6R 220V 6 HANELİ RESETLENEBİLİR MEKANİK SAYICI BESLEME GERİLİMİ 220 VAC"	1	ad.	21.000 USD.
129 087 000350	HM-1 220V İŞ GÜÇ ZAMAN SAATİ, BESLEME GERİLİMİ 220VAC	1	ad.	17.000 USD.

Ürün Kodu	Açıklama / Stok Cinsi	Ambalaj (Kutulu)	Ambalaj Birimi	Fiyat
JOKARİ KABLO SIYIRMA VE KESME İÇİN EL ALETLERİ				
129 087 000351	10160 4-16MM TÜM YUVARLAK KABLO KILIFLARINI SOYMAK İÇİN	1	ad.	13.000 EUR.
129 087 000352	10270 8-28MM TÜM YUVARLAK KABLO KILIFLARINI SOYMAK İÇİN	1	ad.	13.000 EUR.
129 087 000353	10272 8-28MM TÜM YUVARLAK KABLO KILIFLARINI SOYMAK İÇİN	1	ad.	9.000 EUR.
129 087 000354	10280 8-28MM TÜM YUVARLAK KABLO KILIFLARINI SOYMAK İÇİN	1	ad.	14.000 EUR.
129 087 000355	10282 8-28MM TÜM YUVARLAK KABLO KILIFLARINI SOYMAK İÇİN	1	ad.	9.000 EUR.
129 087 000356	10350 27-35MM TÜM YUVARLAK KABLO KILIFLARINI SOYMAK İÇİN	1	ad.	22.000 EUR.
129 087 000357	"20030 GENİŞLİK MAX.12MM YE VARAN VE 0,75-2,5MM ARASI PVC İZALASYON YASSI KABLolar İÇİN"	1	ad.	60.000 EUR.
129 087 000358	20040 0,5-4MM TÜM YUVARLAK KABLO KILIFLARINI SOYMAK İÇİN	1	ad.	17.000 EUR.
129 087 000359	"20050 MAX.2,5MMYE KADAR OLAN İLETKENLER İÇİN, UZUNLUK STOPU 6-15MM ARASI AYARLANABİLİR"	1	ad.	17.000 EUR.
129 087 000360	"20060 MAX.2,5MMYE KADAR OLAN İLETKENLER İÇİN, UZUNLUK STOPU 6-18MM ARASI AYARLANABİLİR"	1	ad.	48.000 EUR.
129 087 000361	20070 PUR VE TPE DIŞ İZALASYONLU AS ARABİRİM KABLolar İÇİN	1	ad.	114.000 EUR.
129 087 000362	20090 ÇAPLARI 6-16MM ARASI OLAN İLETKENLER İÇİN	1	ad.	60.000 EUR.
129 087 000363	"20100 0,2-6MM ARASI SERT VE ESNEK TEK DAMARLI İLETKENLER VE ZİL TELİ İÇİN UZUNLUK STOPU 6-18MM ARASI AYARLANABİLİR"	1	ad.	40.000 EUR.
129 087 000364	30100 TÜM COAX KABLolar İÇİN PVC-FLEXİBLE 3X0,75MM	1	ad.	16.000 EUR.
129 087 000365	"30120 ÇAPLARI 8-13MM ARASI OLAN TÜM YUVARLAK KABLolarIN DIŞ KILIFINI SOYMAK İÇİN"	1	ad.	13.000 EUR.
129 087 000366	"30150 ÇAPLARI 8-13MM ARASI OLAN TÜM YUVARLAK KABLolarIN DIŞ KILIFINI SOYMAK İÇİN"	1	ad.	26.000 EUR.
129 087 000367	"30160 DATA TRANSFERİ VE DENETİM HATLARI İÇİN KULLANILAN PVC İZALASYON KAB.İÇİN ÖZEL.KILIF SOYMA VE İZALASYON SIYIRMAK İÇİN"	1	ad.	38.000 EUR.



TERMOPLASTİK BUATLAR ve KOMBİNASYON KUTULARI (A.B.S)



Ürün Kodu : 001 046 078080 00 17
 Ürün Adı : 80X80X48
 TERMO PLASTİK BUAT (7 ÇIKIŞLI)
 Ambalaj Ad.: 18
 Fiyat : 2.379 TL



Ürün Kodu : 001 046 076131 00 44
 Ürün Adı : 138X226X131
 ŞEFFAF TERMO PLASTİK BUAT
 Ambalaj Ad.: 1
 Fiyat : 9.410 TL



Ürün Kodu : 001 046 078585 00 17
 Ürün Adı : 85X85X48
 TERMOPLASTİK BUAT
 Ambalaj Ad.: 18
 Fiyat : 1.606 TL

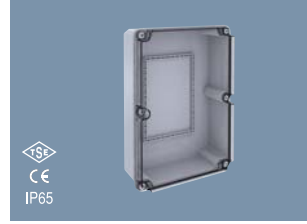

Ürün Kodu : 001 046 071199 00 44
 Ürün Adı : 225X311X99
 ŞEFFAF TERMO PLASTİK BUAT
 Ambalaj Ad.: 1
 Fiyat : 13.247 TL



Ürün Kodu : 001 046 070090 00 17
 Ürün Adı : 90'LİK
 TERMOPLASTİK BUAT
 Ambalaj Ad.: 18
 Fiyat : 1.512 TL

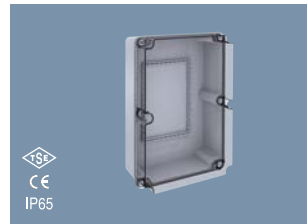

Ürün Kodu : 001 046 071130 00 44
 Ürün Adı : 225X311X130
 ŞEFFAF TERMO PLASTİK BUAT
 Ambalaj Ad.: 1
 Fiyat : 14.783 TL



Ürün Kodu : 001 046 071010 00 17
 Ürün Adı : 110X110X74
 TERMO PLASTİK BUAT (8 ÇIKIŞLI)
 Ambalaj Ad.: 10
 Fiyat : 5.230 TL



Ürün Kodu : 001 046 070098 00 17
 Ürün Adı : 138X226X98
 TERMO PLASTİK BUAT
 Ambalaj Ad.: 1
 Fiyat : 8.335 TL



Ürün Kodu : 001 046 071118 00 17
 Ürün Adı : 110X180X77
 TERMO PLASTİK BUAT (10 ÇIKIŞLI)
 Ambalaj Ad.: 5
 Fiyat : 6.428 TL



Ürün Kodu : 001 046 070131 00 17
 Ürün Adı : 138X226X131
 TERMO PLASTİK BUAT
 Ambalaj Ad.: 1
 Fiyat : 8.645 TL



Ürün Kodu : 001 046 071827 00 17
 Ürün Adı : 180X270X100
 TERMO PLASTİK BUAT (14 ÇIKIŞLI)
 Ambalaj Ad.: 2
 Fiyat : 13.729 TL

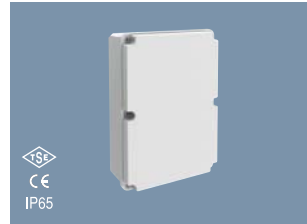

Ürün Kodu : 001 046 070199 00 17
 Ürün Adı : 225X311X99
 TERMO PLASTİK BUAT
 Ambalaj Ad.: 1
 Fiyat : 13.535 TL



Ürün Kodu : 001 046 072698 00 44
 Ürün Adı : 138X226X98
 ŞEFFAF TERMO PLASTİK BUAT
 Ambalaj Ad.: 1
 Fiyat : 8.870 TL



Ürün Kodu : 001 046 070130 00 17
 Ürün Adı : 225X311X130
 TERMO PLASTİK BUAT
 Ambalaj Ad.: 1
 Fiyat : 15.965 TL



TERMOPLASTİK BUATLAR ve KOMBİNASYON KUTULARI (A.B.S)



Ürün Kodu : 001 046 078226 00 17
Ürün Adı : 138X226X127
KOMBİNASYON KUTUSU
(SİGORTALI BOŞ)

Ambalaj Ad. : 1
Fiyat : 12.224 TL



Ürün Kodu : 001 046 075311 00 17
Ürün Adı : 225X311X132
KOMBİNASYON KUTUSU
(SİGORTALI BOŞ)

Ambalaj Ad. : 1
Fiyat : 17.370 TL



TERMOPLASTİK BUATLAR ve KOMBİNASYON KUTULARI (POLİ KARBONAT)



Ürün Kodu : 001 046 172698 00 44
Ürün Adı : 138X226X98
ŞEFFAF TERMO PLASTİK BUAT

Ambalaj Ad. : 1
Fiyat : 7.634 TL

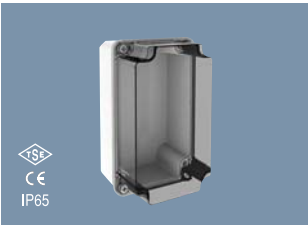

Ürün Kodu : 001 046 176131 00 44
Ürün Adı : 138X226X131
ŞEFFAF TERM OPLASTİK BUAT

Ambalaj Ad. : 1
Fiyat : 9.286 TL

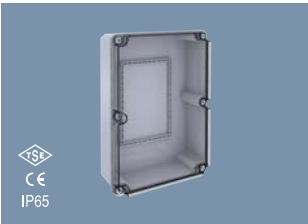

Ürün Kodu : 001 046 171199 00 44
Ürün Adı : 225X311X99
ŞEFFAF TERMO PLASTİK BUAT

Ambalaj Ad. : 1
Fiyat : 12.011 TL

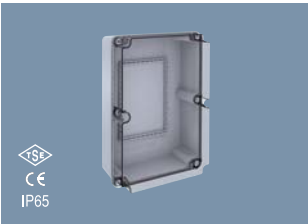

Ürün Kodu : 001 046 171130 00 44
Ürün Adı : 225X311X130
ŞEFFAF TERMO PLASTİK BUAT

Ambalaj Ad. : 1
Fiyat : 13.547 TL



Ürün Kodu : 001 046 170098 00 17
Ürün Adı : 138X226X98
TERMOPLASTİK BUAT

Ambalaj Ad. : 1
Fiyat : 7.099 TL



TERMOPLASTİK BUATLAR ve KOMBİNASYON KUTULARI (POLİ KARBONAT)



Ürün Kodu : 001 046 170131 00 17
Ürün Adı : 138X226X131
TERMO PLASTİK BUAT

Ambalaj Ad. : 1
Fiyat : 7.409 TL



Ürün Kodu : 001 046 170199 00 17
Ürün Adı : 225X311X99
TERMO PLASTİK BUAT

Ambalaj Ad. : 1
Fiyat : 12.299 TL



Ürün Kodu : 001 046 170130 00 17
Ürün Adı : 225X311X130
TERMO PLASTİK BUAT

Ambalaj Ad. : 1
Fiyat : 14.729 TL



Ürün Kodu : 001 046 178226 00 17
Ürün Adı : 138X226X127
KOMBİNASYON KUTUSU
(SİGORTALI BOŞ)

Ambalaj Ad. : 1
Fiyat : 10.988 TL



Ürün Kodu : 001 046 175311 00 17
Ürün Adı : 225X311X132
KOMBİNASYON KUTUSU
(SİGORTALI BOŞ)

Ambalaj Ad. : 1
Fiyat : 16.134 TL



DÖŞEME ALTI PRİZ SİSTEMLERİ



Ürün Kodu : 075 171 000001
 Ürün Adı : GPS-GL-11 FIRÇALI MODEL
 AÇIKLAMA : 2 ad. Siyah priz Mutlusan
 1 ad. Cat 5 data
 1 ad. Cat 3 telefon
 Ambalaj Ad. : 1
 Fiyat : 145.000 TL



Ürün Kodu : 075 171 000007
 Ürün Adı : GSS-GS-11
 TOWER DAĞITICI (100 cm. Boy)
 AÇIKLAMA : 4 ad. Siyah priz Mutlusan
 2 ad. UPS kırmızı priz Mutlusan
 2 ad. Cat 5 data
 2 ad. Cat 3 telefon
 Ambalaj Ad. : 1
 Fiyat : 362.500 TL



Ürün Kodu : 075 171 000002
 Ürün Adı : GPS-D-01 DÖNMELİ MODEL
 AÇIKLAMA : 2 ad. Siyah priz Mutlusan
 1 ad. Cat 5 data
 1 ad. Cat 3 telefon
 Ambalaj Ad. : 1
 Fiyat : 148.750 TL



Ürün Kodu : 075 171 000008
 Ürün Adı : GPS-D-01-M MOTORLU
 DÖNMELİ PRİZ (26 cm. Boy)
 AÇIKLAMA : 2 ad. Siyah priz Mutlusan
 1 ad. Cat 5 data
 1 ad. Cat 3 telefon
 Ambalaj Ad. : 1
 Fiyat : 320.000 TL

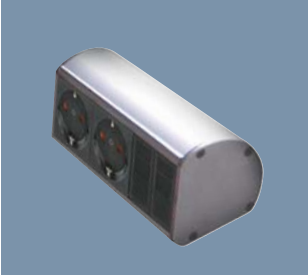

Ürün Kodu : 075 171 000003
 Ürün Adı : TPS-11 TEZGAH ÜSTÜ PRİZ
 AÇIKLAMA : 2 ad. Siyah priz Mutlusan
 1 ad. Cat 5 data
 1 ad. Cat 3 telefon
 Ambalaj Ad. : 1
 Fiyat : 120.000 TL

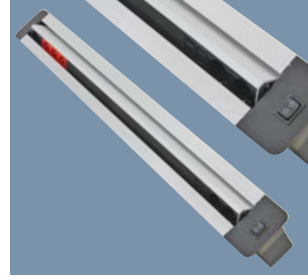

Ürün Kodu : 075 171 000009
 Ürün Adı : GPS-D-01-XM MOTORLU
 DÖNMELİ PRİZ (100 cm. Boy)
 AÇIKLAMA : 4 ad. Siyah priz Mutlusan
 2 ad. UPS kırmızı priz Mutlusan
 2 ad. Cat 5 data
 2 ad. Cat 3 telefon
 Ambalaj Ad. : 1
 Fiyat : 545.000 TL



Ürün Kodu : 075 171 000004
 Ürün Adı : XF-88 BAS-ÇEK PRİZ
 AÇIKLAMA : 3'lü siyah priz
 (Kapak rengi değişebilir)
 Ambalaj Ad. : 1
 Fiyat : 97.500 TL

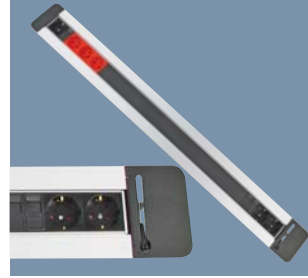

Ürün Kodu : 075 171 000010
 Ürün Adı : GPS-D-01-X
 DÖNMELİ PRİZ (100 cm. Boy)
 AÇIKLAMA : 4 ad. Siyah priz Mutlusan
 2 ad. UPS kırmızı priz Mutlusan
 2 ad. Cat 5 data
 2 ad. Cat 3 telefon
 Ambalaj Ad. : 1
 Fiyat : 312.500 TL



Ürün Kodu : 075 171 000005
 Ürün Adı : GPS-M-11 TOPLANTI PRİZİ
 KAPAKSIZ (100 cm. Boy)
 AÇIKLAMA : 12 ad. siyah priz
 2 ad. Cat 5
 2 ad. Cat 3 telefon
 Ambalaj Ad. : 1
 Fiyat : 352.500 TL



Ürün Kodu : 075 171 000011
 Ürün Adı : GPS-B-12
 BASMALI - DATALI PRİZ
 AÇIKLAMA : 2 ad. Siyah priz Mutlusan
 1 ad. Cat 5 data
 1 ad. Cat 3 telefon
 Ambalaj Ad. : 1
 Fiyat : 195.000 TL

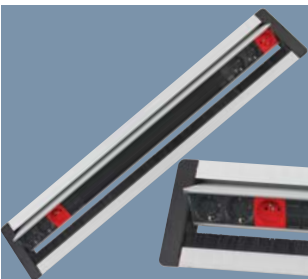

Ürün Kodu : 075 171 000006
 Ürün Adı : GPS-GL-X TOPLANTI PRİZİ
 KAPAKLI-FIRÇALI (100 cm. Boy)
 AÇIKLAMA : 4 ad. Siyah priz Mutlusan
 2 ad. UPS kırmızı priz Mutlusan
 2 ad. Cat 5 data
 2 ad. Cat 3 telefon
 Ambalaj Ad. : 1
 Fiyat : 297.500 TL

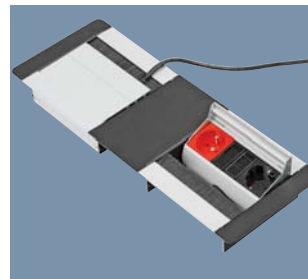

Ürün Kodu : 075 171 000012
 Ürün Adı : GPP-GP-10 ÇİFT TARAFLI -
 FIRÇALI, TOPLANTI PRİZİ
 AÇIKLAMA : 2 ad. Siyah priz Mutlusan
 2 ad. UPS kırmızı priz Mutlusan
 2 ad. Cat 5 data
 2 ad. Cat 3 telefon
 Ambalaj Ad. : 1
 Fiyat : 287.500 TL

DÖŞEME ALTI PRİZ SİSTEMLERİ



Ürün Kodu : 075 171 000013
 Ürün Adı : MET-X-01 FIRÇALI KAPAK SİSTEMİ (21,5 cm. Boy)
 AÇIKLAMA :
 Ambalaj Ad. : 1
 Fiyat : 62.500 TL



Ürün Kodu : 075 171 000019
 Ürün Adı : MET-YK-012 YUVARLAK GÖMME PRİZ SİSTEMİ (Büyük Tip)
 AÇIKLAMA : 1,5 metre kablolar dahil
 1 ad. Siyah priz Mutlusan
 1 ad. UPS kırmızı priz Mutlusan
 1 ad. Cat 5 data
 1 ad. Cat 3 telefon
 Ambalaj Ad. : 1
 Fiyat : 112.500 TL



Ürün Kodu : 075 171 000014
 Ürün Adı : MET-X-02 ALTTAN TAKMA PRİZ SİSTEMİ
 AÇIKLAMA : MET-X-01 ile birlikte kullanılır
 1 ad. Siyah priz Mutlusan
 1 ad. UPS kırmızı priz Mutlusan
 1 ad. Cat 5 data 1 ad. Cat 3 telefon
 Ambalaj Ad. : 1
 Fiyat : 96.250 TL



Ürün Kodu : 075 171 000020
 Ürün Adı : MET-KR-022 DİKDÖRTGEN GÖMME PRİZ SİSTEMİ (2'li)
 AÇIKLAMA : Alt koruyucu kabin beyaz, siyah, gri renk seçenekleri
 1,5 metre kablolar dahil
 1 ad. Siyah priz Mutlusan
 1 ad. Cat 5 data
 1 ad. Cat 3 telefon
 Ambalaj Ad. : 1
 Fiyat : 78.750 TL

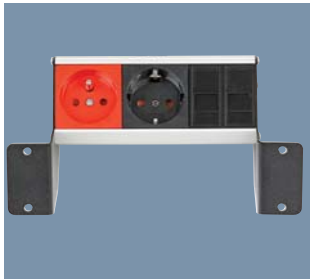

Ürün Kodu : 075 171 000015
 Ürün Adı : MET-X-04 ALTTAN TAKMA PRİZ SİSTEMİ
 AÇIKLAMA : Masa ahsabına monte edilir.
 1 ad. Siyah priz Mutlusan
 1 ad. UPS kırmızı priz Mutlusan
 1 ad. Cat 5 data 1 ad. Cat 3 telefon
 Ambalaj Ad. : 1
 Fiyat : 91.250 TL

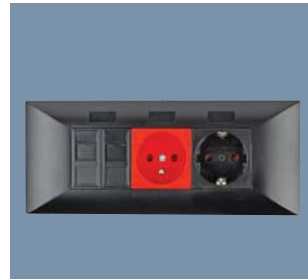

Ürün Kodu : 075 171 000021
 Ürün Adı : MET-KR-023 DİKDÖRTGEN GÖMME PRİZ SİSTEMİ (3'li)
 AÇIKLAMA : Alt koruyucu kabin beyaz, siyah, gri renk seçenekleri
 1,5 metre kablolar dahil
 1 ad. Siyah priz Mutlusan
 1 ad. UPS kırmızı priz Mutlusan
 1 ad. Cat 5 data
 1 ad. Cat 3 telefon
 Ambalaj Ad. : 1
 Fiyat : 95.000 TL



Ürün Kodu : 075 171 000016
 Ürün Adı : MET-X-05 MASA ÜSTÜ KAPAKSIZ PRİZ SİSTEMİ
 AÇIKLAMA : 1 ad. Siyah priz Mutlusan
 1 ad. UPS kırmızı priz Mutlusan
 1 ad. Cat 5 data
 1 ad. Cat 3 telefon
 Ambalaj Ad. : 1
 Fiyat : 98.750 TL



Ürün Kodu : 075 171 000022
 Ürün Adı : MET-UZ-02 ÜSTTEN VİDALI GÖMME PRİZ SİSTEMİ (2'li)
 AÇIKLAMA : Alt kabinsiz beyaz, siyah, gri renk seçenekleri
 1,5 metre kablolar dahil
 1 ad. Siyah priz Mutlusan
 1 ad. Cat 5 data
 1 ad. Cat 3 telefon
 Ambalaj Ad. : 1
 Fiyat : 62.500 TL



Ürün Kodu : 075 171 000017
 Ürün Adı : MET-X-06 ALTTAN TAKMA PRİZ SİSTEMİ
 AÇIKLAMA : Tüm sistemlere uyumlu
 3 ad. Siyah priz Mutlusan
 1 ad. Cat 5 data
 1 ad. Cat 3 telefon
 Ambalaj Ad. : 1
 Fiyat : 86.250 TL



Ürün Kodu : 075 171 000023
 Ürün Adı : MET-UZ-03 ÜSTTEN VİDALI GÖMME PRİZ SİSTEMİ (3'li)
 AÇIKLAMA : Alt kabinsiz beyaz, siyah, gri renk seçenekleri
 1,5 metre kablolar dahil
 1 ad. Siyah priz Mutlusan
 1 ad. UPS kırmızı priz Mutlusan
 1 ad. Cat 5 data
 1 ad. Cat 3 telefon
 Ambalaj Ad. : 1
 Fiyat : 70.000 TL

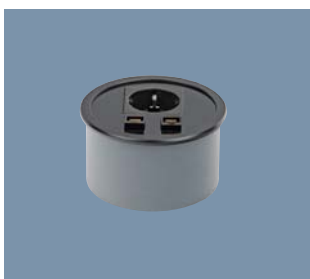

Ürün Kodu : 075 171 000018
 Ürün Adı : MET-YK-011 YUVARLAK GÖMME PRİZ SİSTEMİ (Küçük Tip)
 AÇIKLAMA : 1,5 metre kablolar dahil
 1 ad. Siyah priz Mutlusan
 1 ad. Cat 5 data
 1 ad. Cat 3 telefon
 Ambalaj Ad. : 1
 Fiyat : 87.500 TL



Ürün Kodu : 075 171 000024
 Ürün Adı : MET-GU-05 SÜPÜRGE LİK YER SİSTEMİ
 AÇIKLAMA : 1,5 metre kablolar dahil
 2 ad. Siyah priz Mutlusan
 2 ad. UPS kırmızı priz Mutlusan
 2 ad. Cat 5 data
 2 ad. Cat 3 telefon
 Ambalaj Ad. : 1
 Fiyat : 135.000 TL

TENPO SANAYİ FİŞ-PRİZ GRUBU (MONOFAZE 1X16 A.)



Ürün Kodu : 005 083 300027
Ürün Adı : KOD-27 1X16 A. MONO.TOP.
 ERKEK FİŞ(EĞİK)
Ambalaj Ad. : 50
Fiyat : 3.238 TL



Ürün Kodu : 005 083 300028
Ürün Adı : KOD-28 1X16 A. MONO.TOP.
 ERKEK FİŞ(DÜZ)
Ambalaj Ad. : 50
Fiyat : 3.238 TL

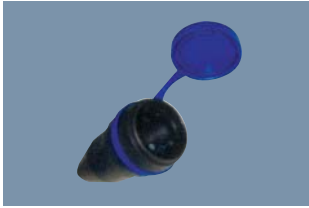

Ürün Kodu : 005 083 300029
Ürün Adı : KOD-29 1X16 A. MONO.
 TOPRAKLI DIŞI FİŞ
Ambalaj Ad. : 25
Fiyat : 4.375 TL

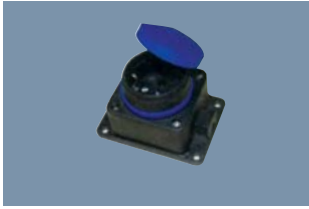

Ürün Kodu : 005 083 500296
Ürün Adı : KOD-29/6 1X16 A. MONO.TOP.
 DUVAR PRİZİ
Ambalaj Ad. : 15
Fiyat : 4.638 TL



Ürün Kodu : 005 083 500292
Ürün Adı : KKOD-29/2 1X16 A. MONO.
 2'Lİ GRUP PRİZ
Ambalaj Ad. : 20
Fiyat : 8.663 TL



Ürün Kodu : 005 083 501292
Ürün Adı : KOD-29/2A 1X16 A. MONO.
 2'Lİ GR.PRİZ ANH.
Ambalaj Ad. : 20
Fiyat : 10.063 TL



Ürün Kodu : 005 083 500293
Ürün Adı : KOD-29/3 1X16 A. MONO.
 3'LÜ GRUP PRİZ
Ambalaj Ad. : 12
Fiyat : 11.375 TL

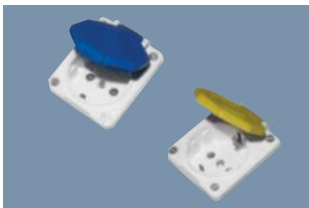

Ürün Kodu : 005 083 500298
Ürün Adı : KOD-29/8 MONOFAZE
 TOPRAKLI PANO PRİZİ
Ambalaj Ad. : 30
Fiyat : 3.500 TL

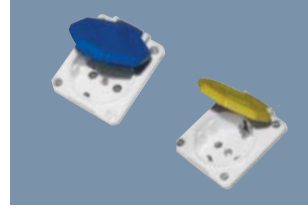

Ürün Kodu : 005 083 501297
Ürün Adı : KOD-29/8-U MONO.UPS
 TOPRAKLI PANO PRİZİ
Ambalaj Ad. : 30
Fiyat : 3.938 TL

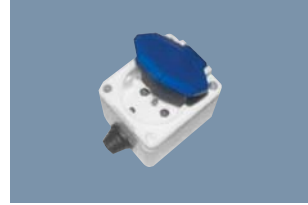

Ürün Kodu : 005 083 500297
Ürün Adı : KOD-29/7 MONO.DUVAR
 PRİZİ (PLASTİK)
Ambalaj Ad. : 30
Fiyat : 4.375 TL

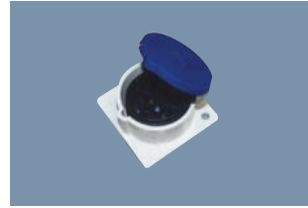

Ürün Kodu : 005 083 500299
Ürün Adı : KOD-29/9 MONO.
 MAKİNA PRİZİ
Ambalaj Ad. : 20
Fiyat : 5.250 TL

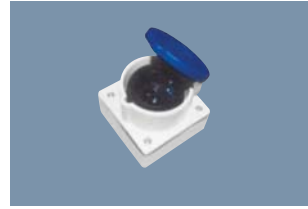

Ürün Kodu : 005 083 502910
Ürün Adı : KOD-29/10 MONO.
 DUVAR PRİZİ
Ambalaj Ad. : 12
Fiyat : 6.125 TL



Ürün Kodu : 005 083 200003
Ürün Adı : TOPRAKLI UZATMA
 KABLOSU (3MT.)
Ambalaj Ad. : 1
Fiyat : 13.125 TL



Ürün Kodu : 005 083 200005
Ürün Adı : TOPRAKLI UZATMA KABLOSU
 (5MT.)
Ambalaj Ad. : 1
Fiyat : 17.500 TL

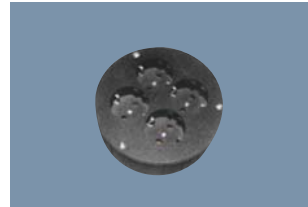

Ürün Kodu : 005 083 500040
Ürün Adı : KOD-40 1X16 A.MONO.4'LÜ
 GR.PRİZ KABLOSUZ
Ambalaj Ad. : 10
Fiyat : 14.875 TL

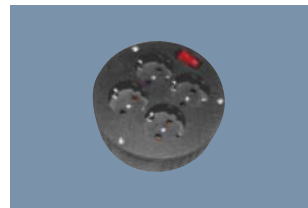

Ürün Kodu : 005 083 500140
Ürün Adı : KOD-40/A 1X16 A.MONO.4'LÜ
 GR.PRİZ ANH.
Ambalaj Ad. : 10
Fiyat : 18.375 TL

TENPO SANAYİ FİŞ-PRİZ GRUBU (TRİFAZE 3X16 A.)



Ürün Kodu : 005 083 400060
Ürün Adı : KOD-60 3X16 TRİFAZE
ERKEK FİŞ
Ambalaj Ad. : 30
Fiyat : 6.125 TL



Ürün Kodu : 005 083 400061
Ürün Adı : KOD-61 3X16 TRİFAZE
SEYYAR DİŞİ FİŞ
Ambalaj Ad. : 25
Fiyat : 7.875 TL



Ürün Kodu : 005 083 400062
Ürün Adı : KOD-62 3X16 TRİFAZE
DUVAR PRİZİ
Ambalaj Ad. : 12
Fiyat : 8.750 TL

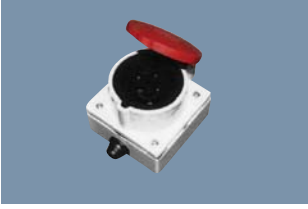

Ürün Kodu : 005 083 400063
Ürün Adı :
Ambalaj Ad. : 12
Fiyat : 10.500 TL

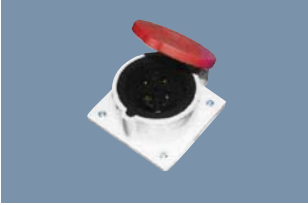

Ürün Kodu : 005 083 400064
Ürün Adı :
Ambalaj Ad. : 20
Fiyat : 7.000 TL

TENPO SANAYİ FİŞ-PRİZ GRUBU (TRİFAZE 3X25 A.)



Ürün Kodu : 005 083 400030
Ürün Adı : KOD-30 3X25 TRİFAZE
ERKEK FİŞ
Ambalaj Ad. : 20
Fiyat : 4.200 TL



Ürün Kodu : 005 083 400031
Ürün Adı : KOD-31 3X25 TRİFAZE DİŞİ
FİŞ (SEYYAR)
Ambalaj Ad. : 20
Fiyat : 5.688 TL



Ürün Kodu : 005 083 600315
Ürün Adı : KOD-31/5 3X25 TRİFAZE
DUVAR PRİZİ
Ambalaj Ad. : 15
Fiyat : 6.125 TL

TENPO SANAYİ FİŞ-PRİZ GRUBU (TRİFAZE 3X25 A.)



Ürün Kodu : 005 083 400319
Ürün Adı : KOD-31/9 3X25 TRİFAZE
DUVAR PRİZİ (PLASTİK)
Ambalaj Ad. : 12
Fiyat : 7.875 TL



Ürün Kodu : 005 083 400318
Ürün Adı : KOD-31/8 3X25 TRİFAZE
MAKİNA PRİZİ (PLASTİK)
Ambalaj Ad. : 20
Fiyat : 7.000 TL



Ürün Kodu : 005 083 600311
Ürün Adı : KOD-31/1 1 TRİFAZE 1
MONOFAZE GRUP PRİZ
Ambalaj Ad. : 15
Fiyat : 16.188 TL



Ürün Kodu : 005 083 600312
Ürün Adı : KOD-31/2 TRİFAZE 2'Lİ
GRUP PRİZ
Ambalaj Ad. : 15
Fiyat : 16.625 TL

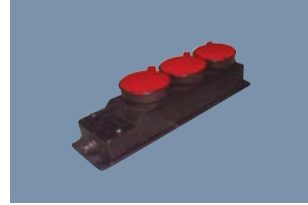

Ürün Kodu : 005 083 600313
Ürün Adı : KOD-31/3 TRİFAZE 3'LÜ
GRUP PRİZ
Ambalaj Ad. : 10
Fiyat : 21.875 TL

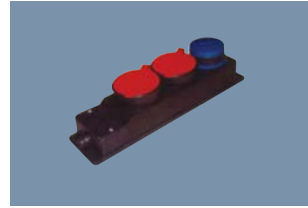

Ürün Kodu : 005 083 600316
Ürün Adı : KOD-31/6. 2 TRİFAZE+1
MONOFAZE GRUP PRİZ
Ambalaj Ad. : 10
Fiyat : 21.000 TL

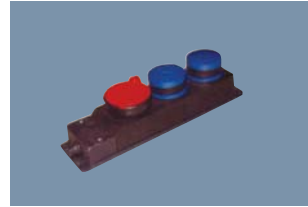

Ürün Kodu : 005 083 600317
Ürün Adı : KOD-31/7 1 TRİFAZE+2
MONOFAZE GRUP PRİZ
Ambalaj Ad. : 10
Fiyat : 20.125 TL

TENPO SANAYİ FİŞ - PRİZ GRUBU (TRİFAZE 3X32 A.)



Ürün Kodu : 005 083 400070
 Ürün Adı : KOD-70 3X32 TRİFAZE
 ERKEK FİŞ
 Ambalaj Ad. : 20
 Fiyat : 9.625 TL



Ürün Kodu : 005 083 400071
 Ürün Adı : KOD-71 3X32 TRİFAZE
 SEYYAR DİŞİ FİŞ
 Ambalaj Ad. : 20
 Fiyat : 11.375 TL



Ürün Kodu : 005 083 400072
 Ürün Adı : KOD-72 3X32 TRİFAZE
 DUVAR PRİZİ
 Ambalaj Ad. : 20
 Fiyat : 13.125 TL



Ürün Kodu : 005 083 400073
 Ürün Adı : KOD-73 3X32 TRİFAZE
 DUVAR PRİZİ (PLS.)
 Ambalaj Ad. : 12
 Fiyat : 10.938 TL



Ürün Kodu : 005 083 400074
 Ürün Adı : KOD-74 3X32 TRİFAZE
 MAKİNE PRİZİ (PLS.)
 Ambalaj Ad. : 20
 Fiyat : 7.875 TL

TENPO AKSESUARLAR FİŞ-PRİZ SERİSİ



Ürün Kodu : 005 083 000006
 Ürün Adı : KOD-18
 BEŞLİ FİŞ
 Ambalaj Ad. : 50
 Fiyat : 1.575 TL



Ürün Kodu : 005 083 000003
 Ürün Adı : KOD-19 ÜÇLÜ FİŞ
 (YENİ TİP)
 Ambalaj Ad. : 16
 Fiyat : 1.575 TL



Ürün Kodu : 005 083 102050
 Ürün Adı : KOD-2050 ÇOK AMAÇLI
 2'Lİ FİŞ-PRİZ
 Ambalaj Ad. : 25
 Fiyat : 3.588 TL

TENPO AKSESUARLAR FİŞ-PRİZ SERİSİ



Ürün Kodu : 005 083 103050
 Ürün Adı : KOD-3050 ÇOK AMAÇLI
 3'LÜ FİŞ-PRİZ (DÜZ)
 Ambalaj Ad. : 20
 Fiyat : 4.288 TL

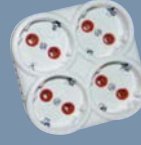

Ürün Kodu : 005 083 104050
 Ürün Adı : KOD-4050 ÇOK AMAÇLI
 4'LÜ FİŞ-PRİZ
 Ambalaj Ad. : 20
 Fiyat : 5.688 TL

TEM FİŞ-PRİZLERİ



Ürün Kodu : 004 077 021615
 Ürün Adı : 2.16.15 PANO PRİZİ
 (SCHUKO TİP)
 Ambalaj Ad. : 48
 Fiyat : 4.255 TL



Ürün Kodu : 004 077 021656
 Ürün Adı : 2.16.56
 ŞEBEKE PRİZİ
 Ambalaj Ad. : 60
 Fiyat : 5.060 TL



Ürün Kodu : 004 077 021666
 Ürün Adı : 2.16.66
 UPS.PRİZİ
 Ambalaj Ad. : 60
 Fiyat : 5.520 TL

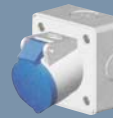

Ürün Kodu : 004 077 031610
 Ürün Adı : 3.16.10
 DUVAR PRİZİ
 Ambalaj Ad. : 12
 Fiyat : 10.350 TL



Ürün Kodu : 004 077 031611
 Ürün Adı : 3.16.11 DUVAR PRİZİ
 EĞİK KASALI
 Ambalaj Ad. : 12
 Fiyat : 18.055 TL



Ürün Kodu : 004 077 131611
 Ürün Adı : 3.16.11.1 DUVAR PR.EĞ.
 KASALI MONO.PRİZLİ
 Ambalaj Ad. : 12
 Fiyat : 15.813 TL

TEM FİŞ-PRİZLERİ



Ürün Kodu : 004 077 031615

Ürün Adı : PANO PRİZİ

Ambalaj Ad.: 12

Fiyat : 8.050 TL



Ürün Kodu : 004 077 031620

Ürün Adı : 3.16.15
SEYYAR PRİZ

Ambalaj Ad.: 12

Fiyat : 9.085 TL

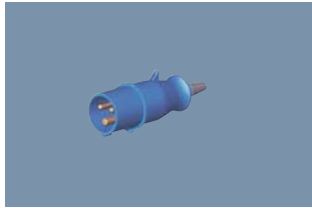

Ürün Kodu : 004 077 031630

Ürün Adı : 3.16.30 FİŞ

Ambalaj Ad.: 12

Fiyat : 6.900 TL



Ürün Kodu : 004 077 033210

Ürün Adı : 3.32.10 DUVAR PRİZİ

Ambalaj Ad.: 6

Fiyat : 15.813 TL

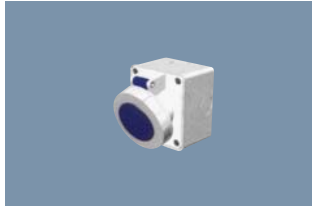

Ürün Kodu : 004 077 233210

Ürün Adı : 3.32.10.K KİLİTLİ KAPAKLI
DUVAR PRİZİ

Ambalaj Ad.: 12

Fiyat : 18.400 TL



Ürün Kodu : 004 077 033215

Ürün Adı : 3.32.15 PANO PRİZİ

Ambalaj Ad.: 12

Fiyat : 11.385 TL

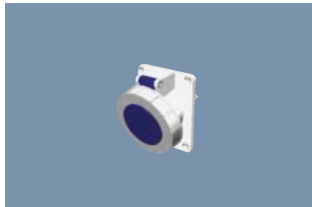

Ürün Kodu : 004 077 133215

Ürün Adı : 3.32.15.K KİLİTLİ KAPAKLI
PANO PRİZİ

Ambalaj Ad.: 12

Fiyat : 13.225 TL



Ürün Kodu : 004 077 033220

Ürün Adı : 3.32.20
SEYYAR PRİZ

Ambalaj Ad.: 12

Fiyat : 12.880 TL

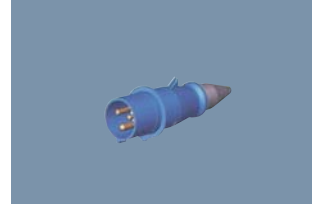

Ürün Kodu : 004 077 033230

Ürün Adı : 3.32.30 FİŞ

Ambalaj Ad.: 12

Fiyat : 10.350 TL



Ürün Kodu : 004 077 033236

Ürün Adı : 3.32.30.K KİLİTLİ FİŞ

Ambalaj Ad.: 12

Fiyat : 12.650 TL

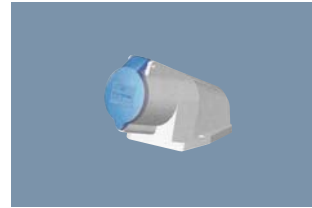

Ürün Kodu : 004 077 033240

Ürün Adı : 3.32.40 DUVAR PRİZİ
(EĞİK)

Ambalaj Ad.: 12

Fiyat : 17.078 TL

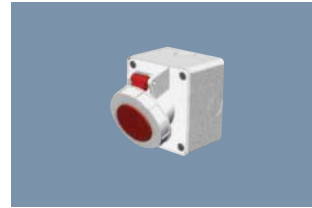

Ürün Kodu : 004 077 241610

Ürün Adı : 4.16.10.K KİLİTLİ KAPAKLI
DUVAR PRİZİ

Ambalaj Ad.: 6

Fiyat : 12.420 TL

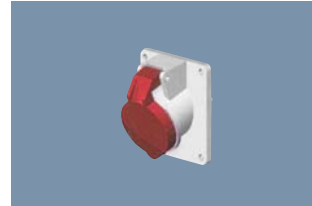

Ürün Kodu : 004 077 041615

Ürün Adı : 4.16.15 PANO PRİZİ

Ambalaj Ad.: 6

Fiyat : 10.120 TL



Ürün Kodu : 004 077 241615

Ürün Adı : 4.16.15.K KİLİTLİ KAPAKLI
PANO PRİZİ

Ambalaj Ad.: 12

Fiyat : 12.075 TL



Ürün Kodu : 004 077 041630

Ürün Adı : 4.16.30 FİŞ

Ambalaj Ad.: 12

Fiyat : 7.820 TL



Ürün Kodu : 004 077 041636

Ürün Adı : 4.16.30.K KİLİTLİ FİŞ

Ambalaj Ad.: 12

Fiyat : 9.200 TL

TEM FİŞ-PRİZLERİ

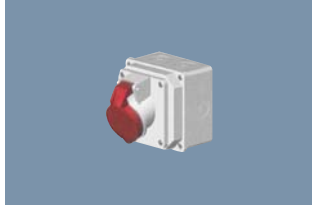

Ürün Kodu : 004 077 043210

Ürün Adı : 4.32.10
DUVAR PRİZİ

Ambalaj Ad.: 6

Fiyat : 18.400 TL



Ürün Kodu : 004 077 043215

Ürün Adı : 4.32.15
PANO PRİZİ

Ambalaj Ad.: 12

Fiyat : 12.880 TL

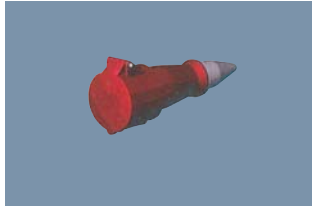

Ürün Kodu : 004 077 043220

Ürün Adı : 4.32.20
SEYYAR PRİZ

Ambalaj Ad.: 12

Fiyat : 14.950 TL



Ürün Kodu : 004 077 043230

Ürün Adı : 4.32.30 FİŞ

Ambalaj Ad.: 12

Fiyat : 10.925 TL



Ürün Kodu : 004 077 043236

Ürün Adı : 4.32.30.K
KİLİTLİ FİŞ

Ambalaj Ad.: 12

Fiyat : 13.685 TL

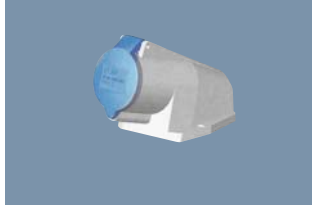

Ürün Kodu : 004 077 043240

Ürün Adı : 4.32.40 DUVAR PRİZİ
(EĞİK)

Ambalaj Ad.: 12

Fiyat : 18.630 TL

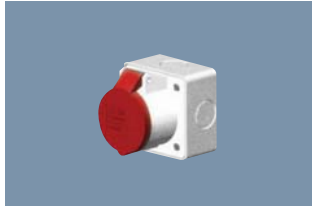

Ürün Kodu : 004 077 051610

Ürün Adı : 5.16.10 DUVAR PRİZİ
(DİK)

Ambalaj Ad.: 12

Fiyat : 13.800 TL

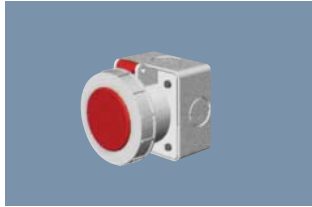

Ürün Kodu : 004 077 251610

Ürün Adı : 5.16.10.K KİLİTLİ KPK.
DUVAR PR.(DİK)

Ambalaj Ad.: 12

Fiyat : 15.295 TL



Ürün Kodu : 004 077 051611

Ürün Adı : 5.16.11 DUVAR PRİZİ
EĞİK KASALI

Ambalaj Ad.: 12

Fiyat : 14.375 TL



Ürün Kodu : 004 077 051615

Ürün Adı : 5.16.15
PANO PRİZİ

Ambalaj Ad.: 12

Fiyat : 11.730 TL



Ürün Kodu : 004 077 251615

Ürün Adı : 5.16.15.K KİLİTLİ KAPAKLI
PANO PRİZİ

Ambalaj Ad.: 12

Fiyat : 13.800 TL

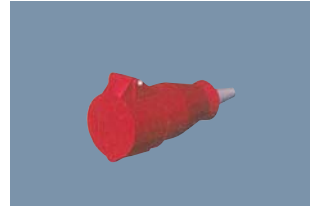

Ürün Kodu : 004 077 051620

Ürün Adı : 5.16.20
SEYYAR PRİZ

Ambalaj Ad.: 12

Fiyat : 12.650 TL



Ürün Kodu : 004 077 051630

Ürün Adı : 5.16.30 FİŞ

Ambalaj Ad.: 12

Fiyat : 9.775 TL



Ürün Kodu : 004 077 051632

Ürün Adı : 5.16.32 EĞİK FİŞ

Ambalaj Ad.: 12

Fiyat : 10.925 TL



Ürün Kodu : 004 077 051636

Ürün Adı : 5.16.30.K KİLİTLİ FİŞ

Ambalaj Ad.: 12

Fiyat : 11.270 TL

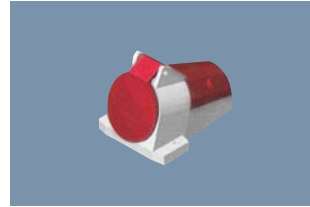

Ürün Kodu : 004 077 051640

Ürün Adı : 5.16.40 DUVAR PRİZİ
(EĞİK)

Ambalaj Ad.: 12

Fiyat : 15.525 TL

TEM FİŞ-PRİZLERİ



Ürün Kodu : 004 007 053210

Ürün Adı : 5.32.10
DUVAR PRİZİ

Ambalaj Ad. : 12

Fiyat : 18.975 TL



Ürün Kodu : 004 077 053215

Ürün Adı : 5.32.15
PANO PRİZİ

Ambalaj Ad. : 12

Fiyat : 14.605 TL



Ürün Kodu : 004 077 253215

Ürün Adı : 5.32.15.K KİLİTLİ KAPAKLI
PANO PRİZİ

Ambalaj Ad. : 12

Fiyat : 16.675 TL



Ürün Kodu : 004 077 053220

Ürün Adı : 5.32.20
SEYYAR PRİZ

Ambalaj Ad. : 12

Fiyat : 15.525 TL

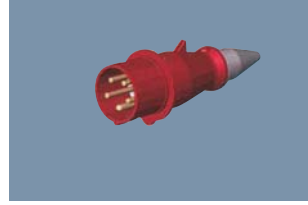

Ürün Kodu : 004 077 053230

Ürün Adı : 5.32.30 FİŞ

Ambalaj Ad. : 12

Fiyat : 12.305 TL



Ürün Kodu : 004 077 053236

Ürün Adı : 5.32.30.K
KİLİTLİ FİŞ

Ambalaj Ad. : 12

Fiyat : 14.375 TL